

i40

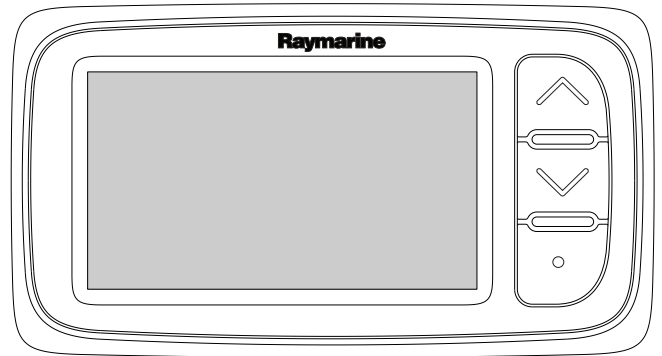

SVMB

Installation and operation instructions

English

Date: 05-2012

Document number: 81340-1-EN

© 2012 Raymarine UK Limited

SWIB

Trademark and patents notice

Autohelm, hsb², RayTech Navigator, Sail Pilot, SeaTalk, SeaTalk^{NG}, SeaTalk^{HS} and Sportpilot are registered trademarks of Raymarine UK Limited. RayTalk, Seahawk, Smartpilot, Pathfinder and Raymarine are registered trademarks of Raymarine Holdings Limited.

FLIR is a registered trademark of FLIR Systems, Inc. and/or its subsidiaries.

All other trademarks, trade names, or company names referenced herein are used for identification only and are the property of their respective owners.

This product is protected by patents, design patents, patents pending, or design patents pending.

Fair Use Statement

You may print no more than three copies of this manual for your own use. You may not make any further copies or distribute or use the manual in any other way including without limitation exploiting the manual commercially or giving or selling copies to third parties.

Software updates

Check the website www.raymarine.com for the latest software releases for your product.

Product handbooks

The latest versions of all English and translated handbooks are available to download in PDF format from the website www.raymarine.com. Please check the website to ensure you have the latest handbooks.

Copyright ©2012 Raymarine UK Ltd. All rights reserved.

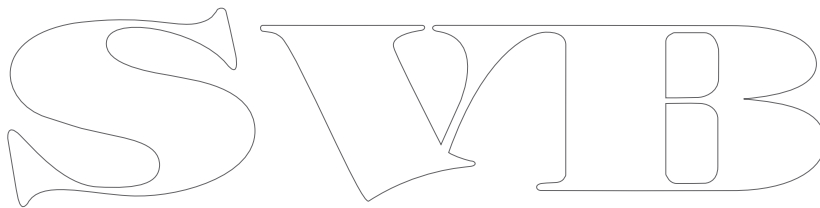
The image shows a large, stylized outline logo for 'SWIB'. The letters are interconnected and have a decorative, calligraphic feel. The 'S' is on the left, followed by 'W', 'I', and 'B' on the right. The entire logo is rendered in a simple black outline on a white background.

SWIB

Contents

Chapter 1 Important information.....	7	9.1 Service and maintenance	48
Safety notices.....	7	9.2 Condensation	48
Water ingress	7	9.3 Routine equipment checks.....	49
Disclaimer	7	9.4 Cleaning.....	49
EMC installation guidelines	7	9.5 Cleaning the display case	50
Suppression ferrites.....	7	9.6 Cleaning the display screen	50
Connections to other equipment	8	Chapter 10 Troubleshooting.....	51
Declaration of conformity.....	8	10.1 Troubleshooting	52
Product disposal.....	8	10.2 Instrument troubleshooting.....	53
Warranty registration.....	8	10.3 Power up troubleshooting	55
IMO and SOLAS.....	8	10.4 Miscellaneous troubleshooting	56
Technical accuracy	8	10.5 Self-test.....	57
Chapter 2 Handbook information.....	9	Chapter 11 Technical support	59
2.1 Handbook information	10	11.1 Raymarine customer support.....	60
Chapter 3 Planning the installation	11	Chapter 12 Technical specification.....	61
3.1 Installation checklist	12	12.1 Technical specification	62
3.2 System integration	13	12.2 Operating ranges	63
3.3 Typical systems	14	Chapter 13 Spares and accessories	65
3.4 Parts supplied.....	15	13.1 Accessories	66
3.5 Tools required	15	13.2 i40 transducers	66
Chapter 4 Cables and connections.....	17	13.3 Spares.....	67
4.1 General cabling guidance	18	13.4 SeaTalk accessories.....	67
4.2 Connections overview	18	13.5 SeaTalk power cables.....	68
4.3 Power connection	20	13.6 Converters.....	68
4.4 SeaTalk ^{ng} connection	21		
Chapter 5 Location and mounting	23		
5.1 Selecting a display location.....	24		
5.2 Mounting	25		
5.3 Bracket mounting	25		
5.4 Selecting a transducer location	26		
5.5 Front bezel	27		
Chapter 6 Getting started	29		
6.1 Controls.....	30		
6.2 Power	30		
6.3 Data master.....	31		
6.4 Adjusting the backlight.....	31		
6.5 Adjusting the contrast.....	32		
6.6 Calibration	32		
Chapter 7 Using your display	37		
7.1 Pages	38		
7.2 i40 Bidata operation	38		
7.3 i40 Depth operation.....	40		
7.4 i40 Speed operation	41		
7.5 i40 Wind operation	42		
Chapter 8 Using alarms	45		
8.1 Alarms.....	46		
Chapter 9 Maintaining your display.....	47		

SWIB

Chapter 1: Important information

Safety notices



Warning: Product installation and operation

This product must be installed and operated in accordance with the instructions provided. Failure to do so could result in personal injury, damage to your vessel and/or poor product performance.



Warning: Potential ignition source

This product is NOT approved for use in hazardous/flammable atmospheres. Do NOT install in a hazardous/flammable atmosphere (such as in an engine room or near fuel tanks).



Warning: High voltage

This product contains high voltage. Adjustments require specialized service procedures and tools only available to qualified service technicians. There are no user serviceable parts or adjustments. The operator should never remove the cover or attempt to service the product.



Warning: Positive ground systems

Do not connect this unit to a system which has positive grounding.



Warning: Switch off power supply

Ensure the vessel's power supply is switched OFF before starting to install this product. Do NOT connect or disconnect equipment with the power switched on, unless instructed in this document.

Caution: Transducer cable

Do NOT cut, shorten, splice the transducer cable or remove the connector. If the cable is cut, it cannot be repaired. Cutting the cable will also void the warranty.

Caution: Power supply protection

When installing this product ensure the power source is adequately protected by means of a suitably-rated fuse or automatic circuit breaker.

Caution: Service and maintenance

This product contains no user serviceable components. Please refer all maintenance and repair to authorized Raymarine dealers. Unauthorized repair may affect your warranty.

Caution: Cleaning

When cleaning this product:

- Do NOT wipe the display screen with a dry cloth, as this could scratch the screen coating.
- Do NOT use abrasive, or acid or ammonia based products.
- Do NOT use a jet wash.

Caution: Condensation

Certain atmospheric conditions may cause a small amount of condensation to form on the unit's window. This will not damage the unit and will clear after the unit has been switched on for a short period.

Water ingress

Water ingress disclaimer

Although the waterproof rating capacity of this product meets the IPX6 standard, water intrusion and subsequent equipment failure may occur if the product is subjected to commercial high-pressure washing. Raymarine will not warrant products subjected to high-pressure washing.

Disclaimer

Raymarine does not warrant that this product is error-free or that it is compatible with products manufactured by any person or entity other than Raymarine.

Raymarine is not responsible for damages or injuries caused by your use or inability to use the product, by the interaction of the product with products manufactured by others, or by errors in information utilized by the product supplied by third parties.

EMC installation guidelines

Raymarine equipment and accessories conform to the appropriate Electromagnetic Compatibility (EMC) regulations, to minimize electromagnetic interference between equipment and minimize the effect such interference could have on the performance of your system.

Correct installation is required to ensure that EMC performance is not compromised.

For optimum EMC performance we recommend that wherever possible:

- Raymarine equipment and cables connected to it are:
 - At least 1 m (3 ft) from any equipment transmitting or cables carrying radio signals e.g. VHF radios, cables and antennas. In the case of SSB radios, the distance should be increased to 7 ft (2 m).
 - More than 2 m (7 ft) from the path of a radar beam. A radar beam can normally be assumed to spread 20 degrees above and below the radiating element.
- The product is supplied from a separate battery from that used for engine start. This is important to prevent erratic behavior and data loss which can occur if the engine start does not have a separate battery.
- Raymarine specified cables are used.
- Cables are not cut or extended, unless doing so is detailed in the installation manual.

Note: Where constraints on the installation prevent any of the above recommendations, always ensure the maximum possible separation between different items of electrical equipment, to provide the best conditions for EMC performance throughout the installation

Suppression ferrites

Raymarine cables may be fitted with suppression ferrites. These are important for correct EMC performance. If a ferrite has to be removed for any purpose (e.g. installation or maintenance), it must be replaced in the original position before the product is used.

Use only ferrites of the correct type, supplied by Raymarine authorized dealers.

Connections to other equipment

Requirement for ferrites on non-Raymarine cables

If your Raymarine equipment is to be connected to other equipment using a cable not supplied by Raymarine, a suppression ferrite **MUST** always be attached to the cable near the Raymarine unit.

Declaration of conformity

Raymarine UK Ltd. declares that this product is compliant with the essential requirements of EMC directive 2004/108/EC.

The original Declaration of Conformity certificate may be viewed on the relevant product page at www.raymarine.com.

Product disposal

Dispose of this product in accordance with the WEEE Directive.



The Waste Electrical and Electronic Equipment (WEEE) Directive requires the recycling of waste electrical and electronic equipment. Whilst the WEEE Directive does not apply to some Raymarine products, we support its policy and ask you to be aware of how to dispose of this product.

Warranty registration

To register your Raymarine product ownership, please visit www.raymarine.com and register online.

It is important that you register your product to receive full warranty benefits. Your unit package includes a bar code label indicating the serial number of the unit. You will need this serial number when registering your product online. You should retain the label for future reference.

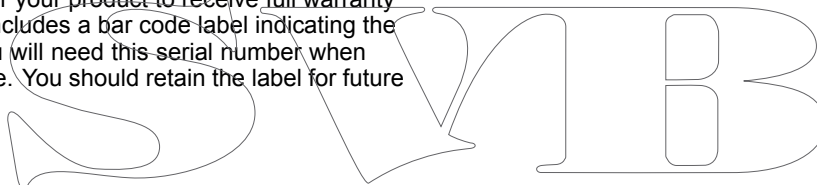

IMO and SOLAS

The equipment described within this document is intended for use on leisure marine boats and workboats not covered by International Maritime Organization (IMO) and Safety of Life at Sea (SOLAS) Carriage Regulations.

Technical accuracy

To the best of our knowledge, the information in this document was correct at the time it was produced. However, Raymarine cannot accept liability for any inaccuracies or omissions it may contain. In addition, our policy of continuous product improvement may change specifications without notice. As a result, Raymarine cannot accept liability for any differences between the product and this document. Please check the Raymarine website (www.raymarine.com) to ensure you have the most up-to-date version(s) of the documentation for your product.

Chapter 2: Handbook information

Chapter contents

- [2.1 Handbook information on page 10](#)

SWIB

2.1 Handbook information

This handbook contains important information regarding your Raymarine instrument display.

i40 Handbooks

The following handbooks are applicable to your product:

Handbooks

Description	Part number
Mounting and getting started	88006
Installation and operation instructions	81340
Mounting template	87155

i40 instrument range

Raymarine's i40 instrument range consists of the following variants:

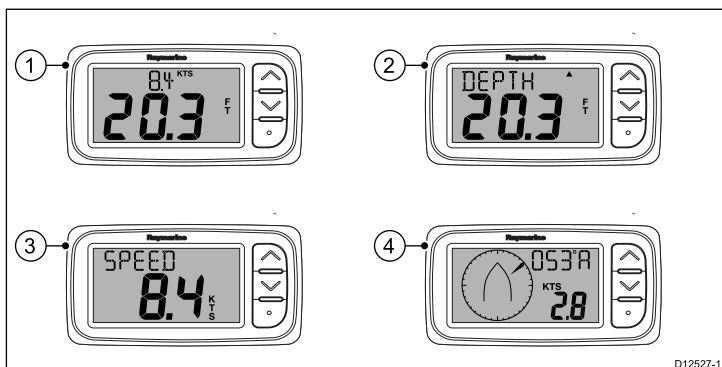

Item	Description	Part number
1	i40 Bidata	E70066
2	i40 Depth	E70064
3	i40 Speed	E70063
4	i40 Wind	E70065

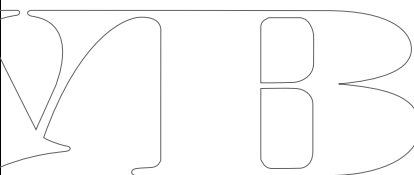

Chapter 3: Planning the installation

Chapter contents

- [3.1 Installation checklist on page 12](#)
- [3.2 System integration on page 13](#)
- [3.3 Typical systems on page 14](#)
- [3.4 Parts supplied on page 15](#)
- [3.5 Tools required on page 15](#)

SWIB

3.1 Installation checklist

Installation includes the following activities:

Installation Task	
1	Plan your system.
2	Obtain all required equipment and tools.
3	Site all equipment.
4	Route all cables.
5	Drill cable and mounting holes.
6	Make all connections into equipment.
7	Secure all equipment in place.
8	Power on and test the system.

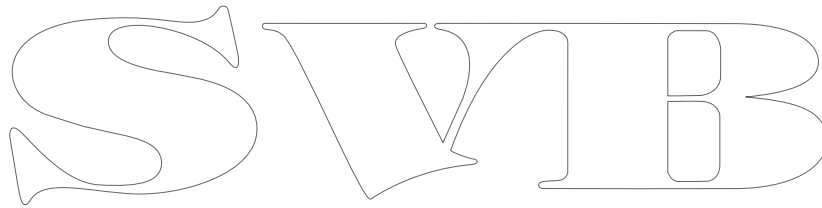
A large, stylized outline logo consisting of the letters 'S', 'W', 'I', and 'B' in a decorative, serif font. The letters are interconnected and have a classic, elegant appearance.

3.2 System integration

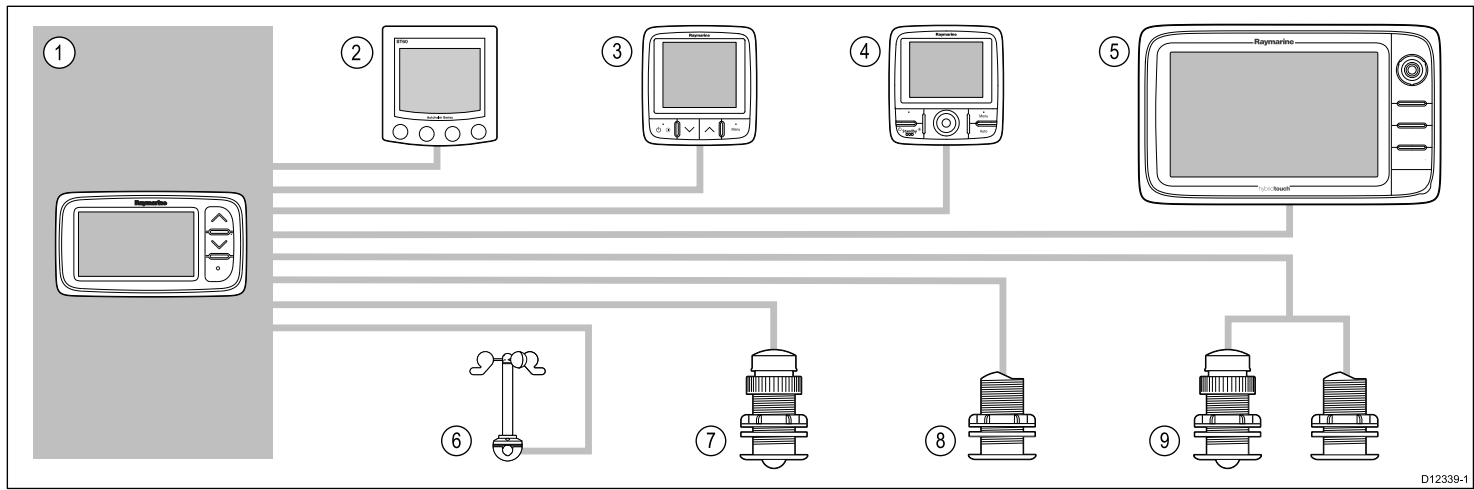

D12339-1

Item	Device type	Maximum Quantity	Suitable Devices	Connections
1	i40 Bidata, Depth, Speed or Wind instrument.	As determined by the SeaTalk bus bandwidth and power loading.	<ul style="list-style-type: none"> i40 Bidata i40 Depth i40 Speed i40 Wind 	<ul style="list-style-type: none"> SeaTalk SeaTalk^{ng} via the optional SeaTalk1 to SeaTalk^{ng} converter.
2	SeaTalk instrument displays via SeaTalk network.	As determined by the SeaTalk bus bandwidth and power loading.	<ul style="list-style-type: none"> ST40 ST60+ 	<ul style="list-style-type: none"> SeaTalk
3	SeaTalk ^{ng} Instrument displays via SeaTalk to SeaTalk ^{ng} converter or adaptor cable.	As determined by the SeaTalk ^{ng} bus bandwidth and power loading.	<ul style="list-style-type: none"> ST70 ST70+ i70 	<ul style="list-style-type: none"> SeaTalk^{ng}
4	SeaTalk ^{ng} pilot controller via SeaTalk to SeaTalk ^{ng} converter.	As determined by the SeaTalk ^{ng} bus bandwidth and power loading.	<ul style="list-style-type: none"> ST70 ST70+ p70 p70R 	<ul style="list-style-type: none"> SeaTalk^{ng}
5	SeaTalk ^{ng} Multifunction displays via SeaTalk to SeaTalk ^{ng} converter.	6	<ul style="list-style-type: none"> Raymarine multifunction displays. 	<ul style="list-style-type: none"> SeaTalk^{ng}
6	Raymarine wind transducer (i40 Wind).	1	<ul style="list-style-type: none"> Rotavecta wind transducer 	Raymarine transducer connection.
7	Raymarine speed and temperature transducer (i40 Speed).	1	<ul style="list-style-type: none"> P731 Shorty through hull speed/temp transducer Other compatible transducers — Please contact your local Raymarine dealer for details. 	Raymarine transducer connection.
8	Raymarine depth transducer (i40 Depth).	1	<ul style="list-style-type: none"> P7 Shorty low profile through hull depth transducer Other compatible transducers — Please contact your local Raymarine dealer for details. 	Raymarine transducer connection.
9	Raymarine analog speed and depth transducers (i40 Bidata).	<ul style="list-style-type: none"> 1 x depth and 1 x Speed/Temp transducers, or 1 x depth, speed and temperature (DST) transducer. 	<ul style="list-style-type: none"> P731 Shorty through hull speed/temp transducer P7 Shorty low profile through hull depth transducer Other compatible transducers — Please contact your local Raymarine dealer for details. 	Raymarine transducer connections.

3.3 Typical systems

Basic SeaTalk system

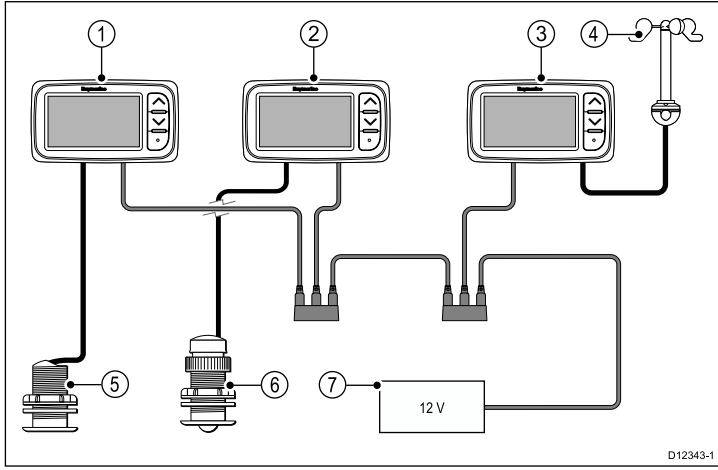

D12343-1

1	i40 Depth instrument display
2	i40 Speed instrument display
3	i40 Wind instrument display
4	Rotavecta wind transducer
5	Depth transducer
6	Speed transducer
7	12 V dc power supply

7	i40 Speed instrument
8	i40 Wind instrument
9	Depth transducer
10	Speed transducer
11	Rotavecta wind transducer

SeaTalk

SeaTalk is a protocol which enables compatible instruments to connect to each other and share data.

The SeaTalk cable system is used to connect compatible instruments and equipment. The cable carries power and data and enables connection without the need for a central processor.

Additional instruments and functions can be added to a SeaTalk system, simply by plugging them into the network. SeaTalk equipment can also communicate with other non-SeaTalk equipment via the NMEA 0183 standard, provided a suitable interface is used.

Basic SeaTalk^{ng} system

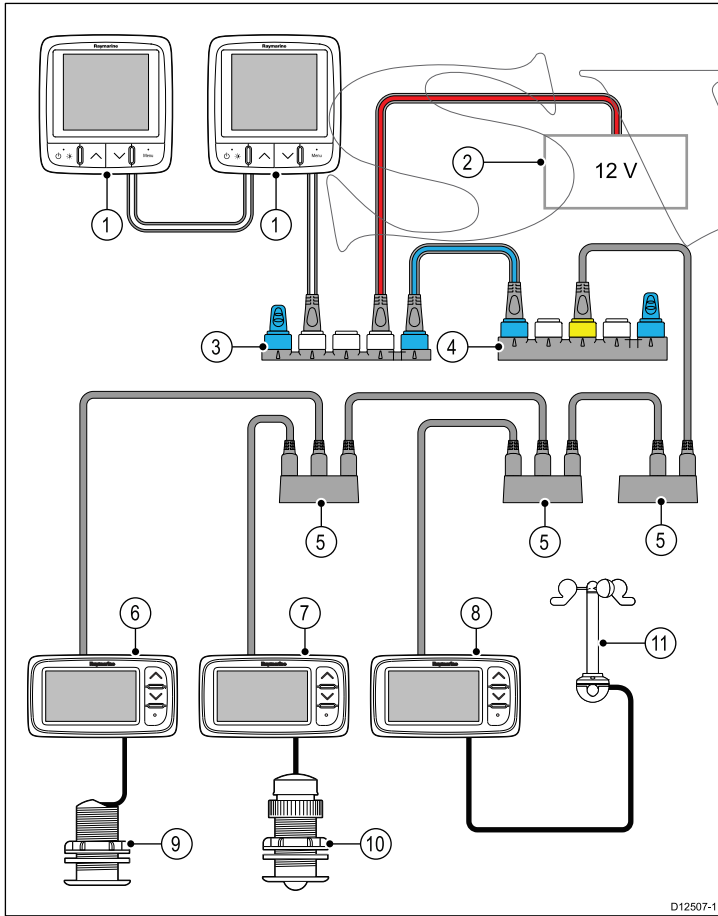

D12507-1

1	SeaTalk ^{ng} instrument displays
2	12 V dc power supply
3	SeaTalk ^{ng} 5 way block
4	SeaTalk to SeaTalk ^{ng} converter
5	SeaTalk 3 way blocks
6	i40 Depth instrument

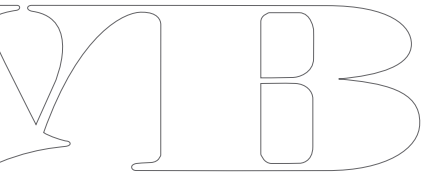

3.4 Parts supplied

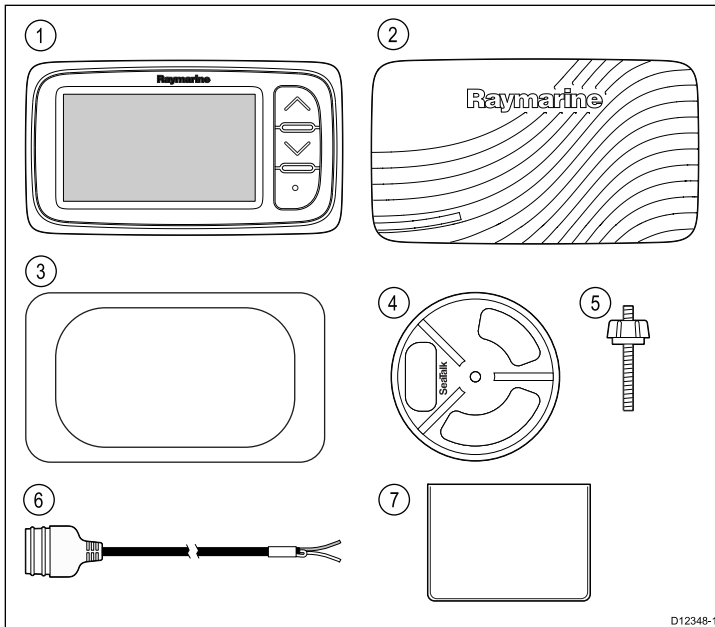

1	i40 Instrument
2	i40 Sun cover
3	Mounting gasket
4	Clamping bracket
5	Fixing stud and thumb nut
6	SeaTalk power cable
7	Document pack

3.5 Tools required

Tools required for installation

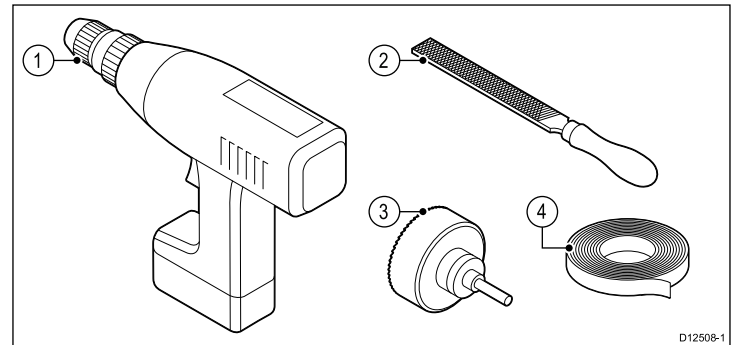

1	Power drill
2	File
3	57 mm (2.25 in) hole cutter
4	Adhesive tape

SVIB

SWIB

Chapter 4: Cables and connections

Chapter contents

- [4.1 General cabling guidance on page 18](#)
- [4.2 Connections overview on page 18](#)
- [4.3 Power connection on page 20](#)
- [4.4 SeaTalk^{ng} connection on page 21](#)

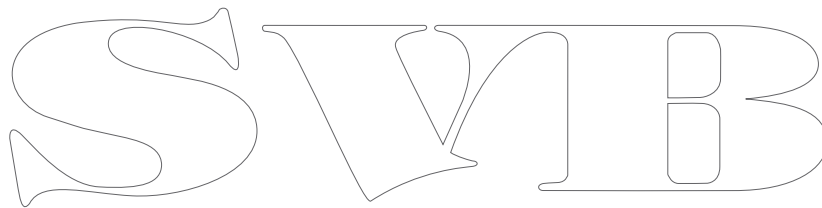

4.1 General cabling guidance

Cable types and length

It is important to use cables of the appropriate type and length

- Unless otherwise stated use only standard cables of the correct type, supplied by Raymarine.
- Ensure that any non-Raymarine cables are of the correct quality and gauge. For example, longer power cable runs may require larger wire gauges to minimize voltage drop along the run.

Routing cables

Cables must be routed correctly, to maximize performance and prolong cable life.

- Do NOT bend cables excessively. Wherever possible, ensure a minimum bend diameter of 200 mm (8 in) / minimum bend radius of 100 mm (4 in).

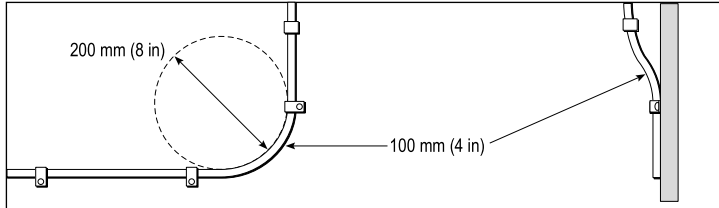

- Protect all cables from physical damage and exposure to heat. Use trunking or conduit where possible. Do NOT run cables through bilges or doorways, or close to moving or hot objects.
- Secure cables in place using tie-wraps or lacing twine. Coil any extra cable and tie it out of the way.
- Where a cable passes through an exposed bulkhead or deckhead, use a suitable watertight feed-through.
- Do NOT run cables near to engines or fluorescent lights.

Always route data cables as far away as possible from:

- other equipment and cables.
- high current carrying ac and dc power lines.
- antennae.

Strain relief

Ensure adequate strain relief is provided. Protect connectors from strain and ensure they will not pull out under extreme sea conditions.

Cable shielding

Ensure that all data cables are properly shielded that the cable shielding is intact (e.g. hasn't been scraped off by being squeezed through a tight area).

4.2 Connections overview

Connections are made using the provided SeaTalk and transducer cable connectors on the rear of the unit.

Connections

SeaTalk connection

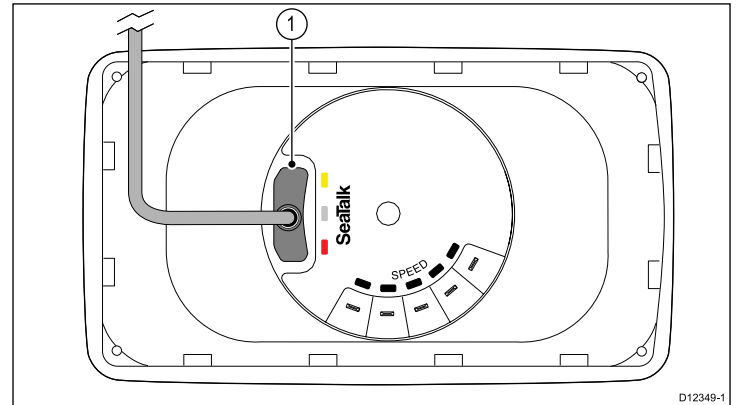

1	SeaTalk connection
---	--------------------

i40 Bidata connection

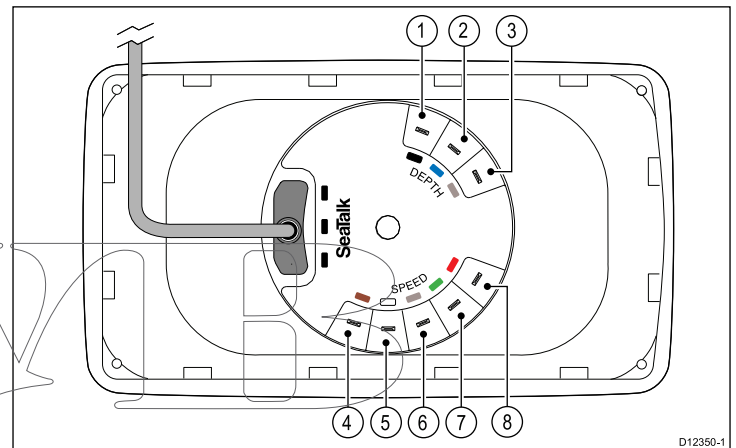

Item	Cable color	Signal name
1	Black (Depth)	Piezoceramic -
2	Blue (Depth)	Piezoceramic +
3	Screen (Depth)	0 V (shield)
4	Brown (Speed)	Temperature 0 V
5	White (Speed)	Temperature (signal)
6	Screen (Speed)	Speed 0 V (shield)
7	Green (Speed)	Speed (signal)
8	Red (Speed)	Speed V+

i40 Depth connection

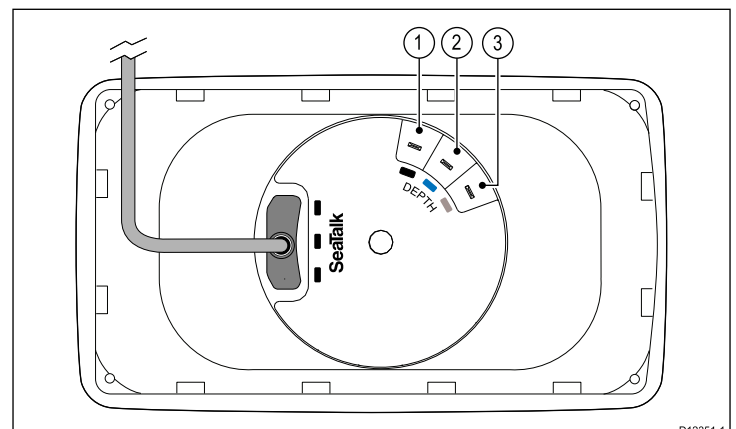

Item	Cable color	Signal name
1	Black	Piezoceramic -
2	Blue	Piezoceramic +
3	Screen	0 V (shield)

1. Prepare the cable as shown in 1 above.
2. Fold back the wire strands and insert into the new spade connector as shown in 2 above.
3. Ensure the wire strands do not extend beyond the rear of the spade connector insulation.
4. Crimp the connector to the wire.

i40 Speed connection

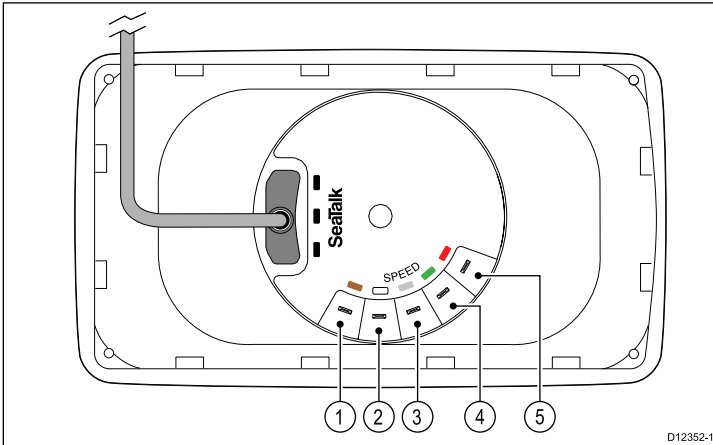

Item	Cable color	Signal name
1	Brown	Temperature 0 V
2	White	Temperature (signal)
3	Screen	Speed 0 V (shield)
4	Green	Speed (signal)
5	Red	Speed V+

i40 Wind connection

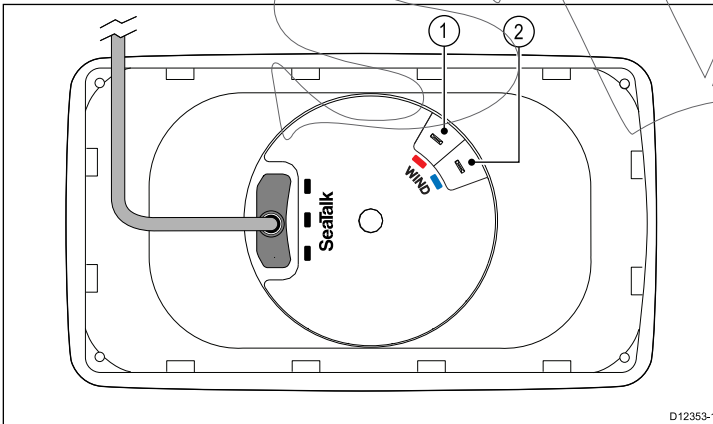

Item	Cable color	Signal name
1	Red	Rotor +
2	Blue	Rotor -

Making transducer connections

Although the transducer cable is fitted with spade connectors for direct connection to the rear of the unit, it may be necessary to remove these to facilitate installation, e.g. if the cable has to be routed through narrow apertures. 1/8th spade terminals will be required (not supplied), to replace those removed. When fitting the new spade connectors, prepare the cables as detailed below:

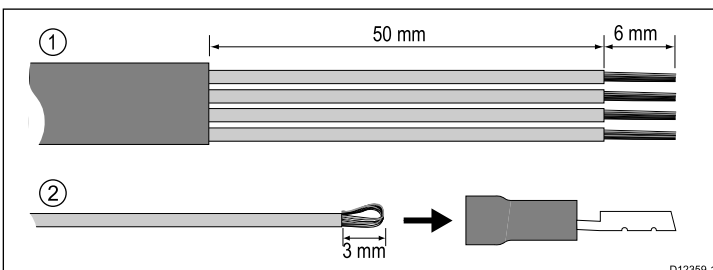

4.3 Power connection

Power can be supplied to the unit either directly or as part of the SeaTalk network.

A SeaTalk system requires one 12 V dc supply, connected to the SeaTalk backbone. This can be provided:

- By a battery via the distribution panel, or
- From a Raymarine course computer, via SeaTalk or SeaTalk^{ng}.

Power connection example

Direct power connection

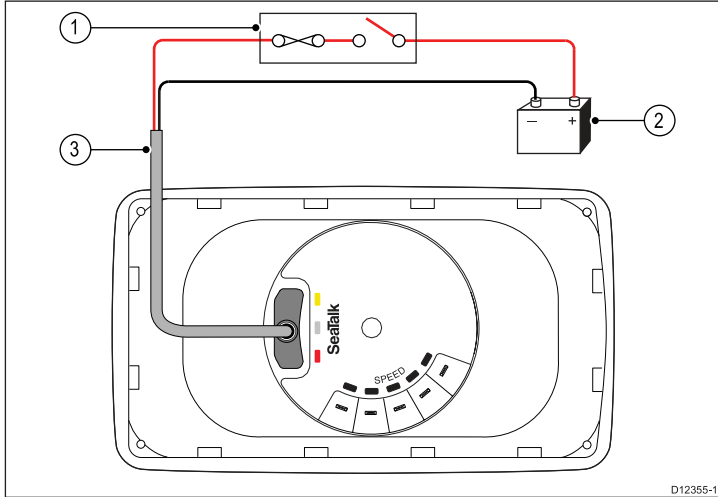

D12355-1

1	3 A circuit breaker or fuse.
2	SeaTalk power cable.
3	12 V dc vessel power supply.

SeaTalk power connection

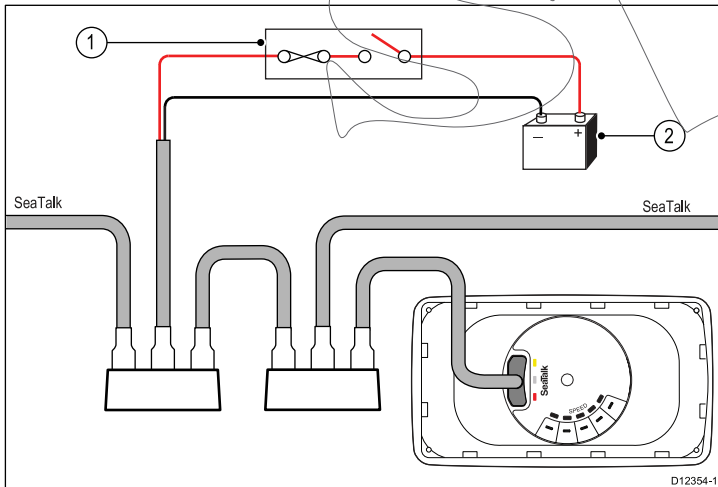

D12354-1

1	5 A circuit breaker or fuse.
2	12 V dc vessel power supply.

SeaTalk power protection

The power supply must be protected by a 5 A fuse or a circuit breaker providing equivalent protection.

Raymarine recommends that the power is connected to a SeaTalk system in such a way that the current drawn on each side of the power connection point is equal.

Warning: Grounding not required
This product is fully insulated and does NOT require separate grounding.

Warning: Positive ground systems
Do not connect this unit to a system which has positive grounding.

SeaTalk power cables

Part number	Description
D229	SeaTalk power cable.

Power cable extension (12 V)

The following restrictions apply to any extension to the power cable:

- Cable must be of a suitable gauge for the circuit load.
- Cable must be wired back to the distribution panel.

Total length (max)	Cable gauge (AWG)
0 to 5 m (0 to 16.4 ft)	18
5 to 10 m (16.4 to 32.8 ft)	14
10 to 15 m (32.8 to 49.2 ft)	12
15 to 20 m (49.2 to 65.5 ft)	12

SeaTalk accessories

SeaTalk cables and accessories for use with compatible products.

Description	Part No	Notes
3-way SeaTalk junction box	D244	
1 m (3.28 ft) SeaTalk extension cable	D284	
3 m (9.8 ft) SeaTalk extension cable	D285	
5 m (16.4 ft) SeaTalk extension cable	D286	
9 m (29.5 ft) SeaTalk extension cable	D287	
12 m (39.4 ft) SeaTalk extension cable	E25051	
20 m (65.6 ft) SeaTalk extension cable	D288	

4.4 SeaTalk^{ng} connection

You can connect your SeaTalk product to a SeaTalk^{ng} system using the SeaTalk to SeaTalk^{ng} converter.

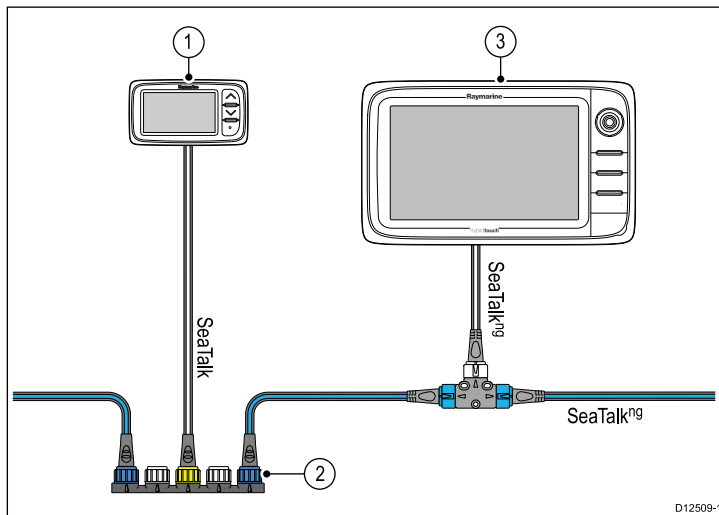

1	i40 instrument
2	SeaTalk to SeaTalk ^{ng} converter
3	Raymarine multifunction display

SWIB

SWIB

Chapter 5: Location and mounting

Chapter contents

- [5.1 Selecting a display location on page 24](#)
- [5.2 Mounting on page 25](#)
- [5.3 Bracket mounting on page 25](#)
- [5.4 Selecting a transducer location on page 26](#)
- [5.5 Front bezel on page 27](#)

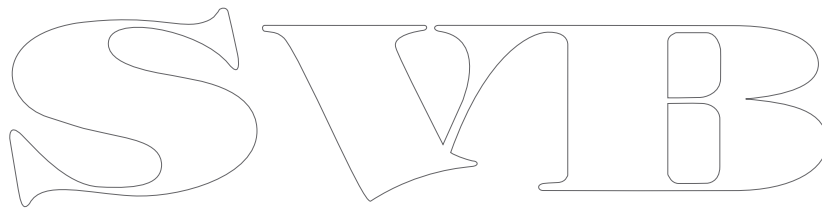

5.1 Selecting a display location



Warning: Potential ignition source

This product is NOT approved for use in hazardous/flammable atmospheres. Do NOT install in a hazardous/flammable atmosphere (such as in an engine room or near fuel tanks).

General location requirements

When selecting a location for the unit it is important to consider a number of factors.

Ventilation requirements

To provide adequate airflow:

- Ensure that equipment is mounted in a compartment of suitable size.
- Ensure that ventilation holes are not obstructed.
- Ensure adequate separation of equipment.

Mounting surface requirements

Ensure units are adequately supported on a secure surface. Do NOT mount units or cut holes in places which may damage the structure of the vessel.

Cable routing requirements

Ensure the unit is mounted in a location which allows proper routing and connection of cables:

- Minimum cable bend radius of 100 mm (3.94 in) is required unless otherwise stated.
- Use cable supports to prevent stress on connectors.

Water ingress

This unit is suitable for mounting both above and below decks. It is waterproof to IPX6 standard. Although the unit is waterproof, it is good practice to locate it in a protected area away from prolonged and direct exposure to rain and salt spray.

Electrical interference

Select a location that is far enough away from devices that may cause interference, such as motors, generators and radio transmitters/receivers.

Magnetic compass

When choosing a suitable location you should aim to maintain the maximum possible distance between the unit and any compasses.

To prevent potential interference with the vessel's magnetic compasses, ensure that a minimum distance of 230 mm (9 in) between the unit and any installed compasses is maintained.

Viewing angle considerations

As display contrast, color and night mode performance are all affected by the viewing angle, Raymarine recommends you temporarily power up the display when planning the installation, to enable you to best judge which location gives the optimum viewing angle.

Viewing angle

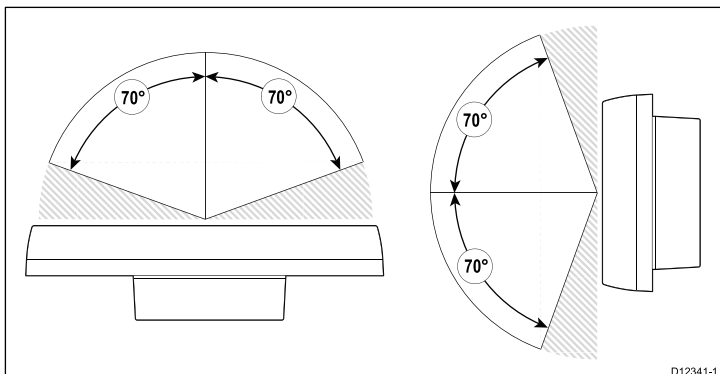

Product dimensions

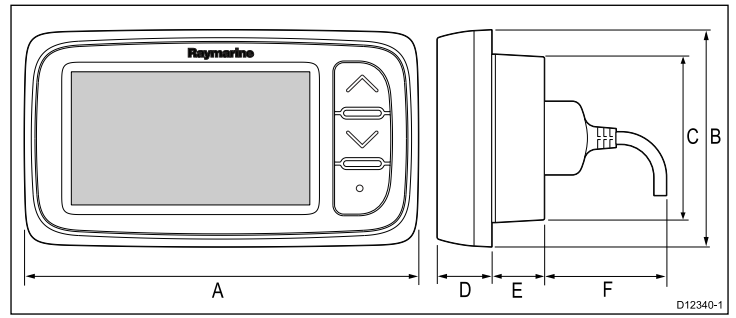

A	128 mm (5.04 in)
B	72 mm (2.83 in)
C	55 mm (2.17 in)
D	18 mm (0.7 in)
E	17 mm (0.67 in)
F	30 mm (1.18 in)

5.2 Mounting

Pre-mounting check

The product is designed to be surface mounted. Before mounting the unit, ensure you have:

- Selected a suitable location.
- Identified the cable connections and route that the cables will take.

Mounting diagram

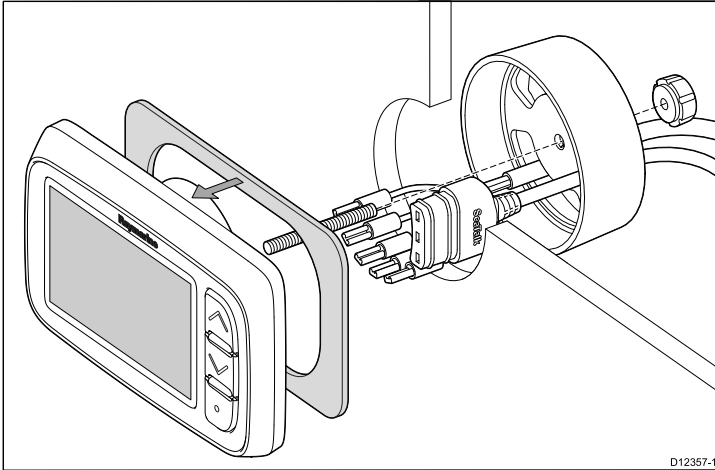

5.3 Bracket mounting

To bracket mount the unit, follow the instructions supplied with the mounting bracket (Part number E25024).

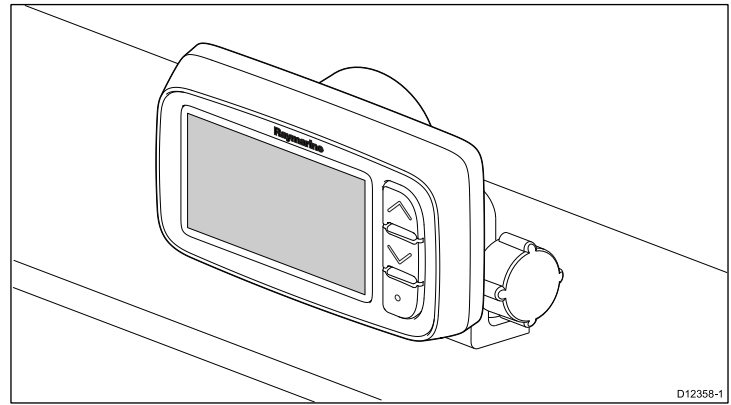

Mounting instructions

1. Check the selected location for the unit. A clear, flat area with suitable clearance behind the panel is required.
2. Fix the supplied mounting template to the selected location, using masking or self adhesive tape.
3. If possible use an appropriate size hole cutting saw to cut-out the center hole area as indicated on the mounting template; or
4. Using a suitable hole cutting saw, make pilot holes in each corner of the cut-out area, and using a jigsaw cut along the inside edge of the cut-out line.
5. Ensure that the unit fits into the removed area and then file around the cut edge until smooth.
6. Peel the backing off the supplied gasket and place the adhesive side of the gasket onto the display unit and press firmly onto the flange.
7. Screw the supplied mounting stud into the back of the unit.
8. Feed cables through the supplied clamping bracket and connect to the unit.
9. Secure the instrument and bracket using the thumb nut and stud.

5.4 Selecting a transducer location

General speed and depth transducer location requirements

When selecting a location for your transducer it is important to consider a number of factors.

The transducer should be mounted within the clear water flow areas indicated by the shaded areas in the image below.

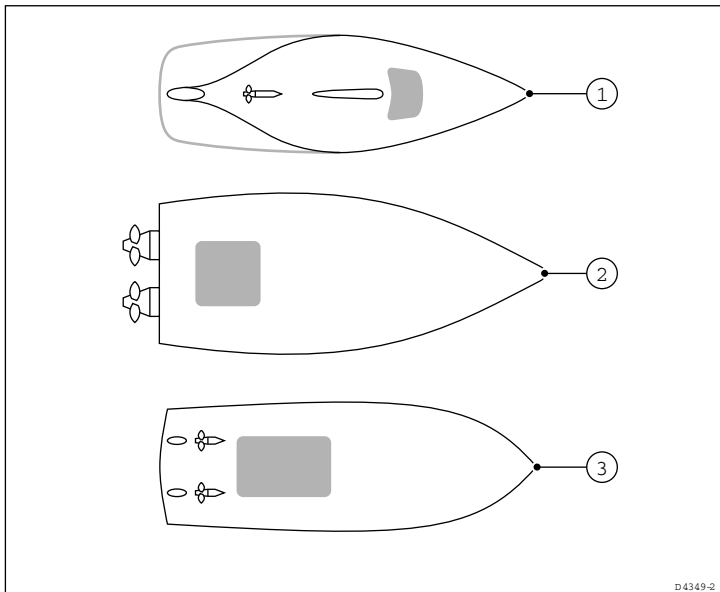

D4349-2

1	Sailing vessel
2	Planing power vessel
3	Displacement power vessel

Each transducer should also:

- Be ahead of the propellers (by a minimum of 10% of the water line length).
- Be at least 150 mm (6 in) away from the keel (ideally ahead of the keel on a sailing yacht).
- Be as near as possible to the center line of the vessel.
- Be clear of other through-hull fittings or projections.
- Have sufficient clearance inside the hull to fit the nut.
- Have 100 mm (4 in) of headroom to allow for withdrawal.

Note: In addition to the above requirements, the depth transducer must be mounted within 10° of the vertical.

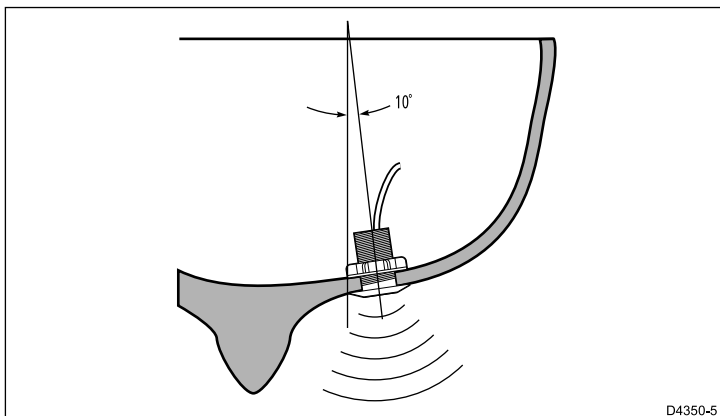

D4350-5

Speed and depth transducer mounting

Ensure transducers are installed in accordance with the instructions supplied with the transducer.

Rotavecta transducer mounting

The rotavecta transducer can be mounted on a flat surface or rail mounted.

Using the rail clamp

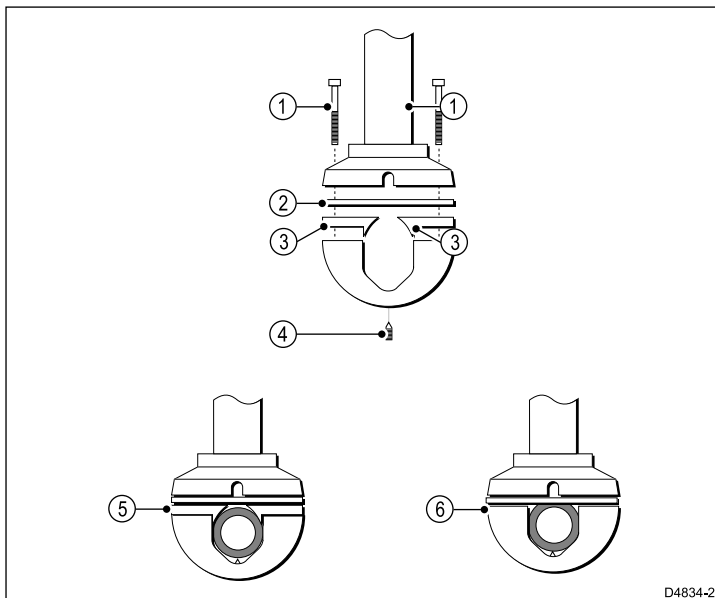

D4834-2

1	Clamp screws.
2	Gasket.
3	Adaptor pieces.
4	Grub screw.
5	Rail diameter 23 mm (0.9 in) or more. If less than 25 mm (1.0 in), use adaptor pieces.
6	Rail diameter 25 mm (1.0 in). Do NOT use adaptor pieces.

Wind vane transducer / rotavecta location requirements

When selecting a location for your wind transducer it is important to consider a number of factors.

The transducer's location must:

- Allow reasonable access for installation and servicing.
- Be as high as possible and away from any equipment which may shield the transducer or otherwise disturb the air flow.
- Provide a horizontal mounting surface. If a surface (e.g. mast top) is otherwise suitable but not horizontal, make up a suitable wedged packing piece to provide the necessary horizontal surface.
- There must also be a viable route for the transducer cable to be routed to the instrument display.

Wind vane transducer and rotavecta mounting

Ensure that the wind transducer or rotavecta is installed in accordance with the instructions supplied with the unit.

5.5 Front bezel

Removing the front bezel

Note: You do not need to remove the front bezel when mounting the unit.

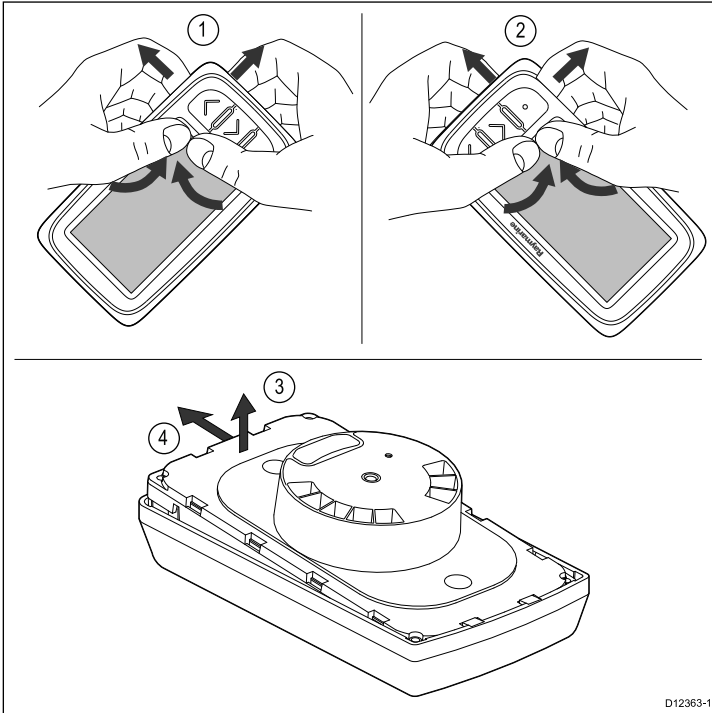

1. Remove the unit from the mounting surface or mounting bracket and disconnect the cables.
2. Using your fingers pull the bezel up and away from the unit at the top corner, nearest the buttons, as shown in 1. The bezel will start to come away from the unit at the top corner.
3. Using your fingers pull the bezel up and away from the unit at the bottom corner, nearest the buttons, as shown in 2.
4. Pull the unit away from the bezel and slide unit away from lugs on opposite side of the bezel, as shown in 3 and 4. The bezel will now come free from the unit.

Important: Use care when removing the bezel. Do not use any tools to lever the bezel, doing so may cause damage.

Fitting the front bezel

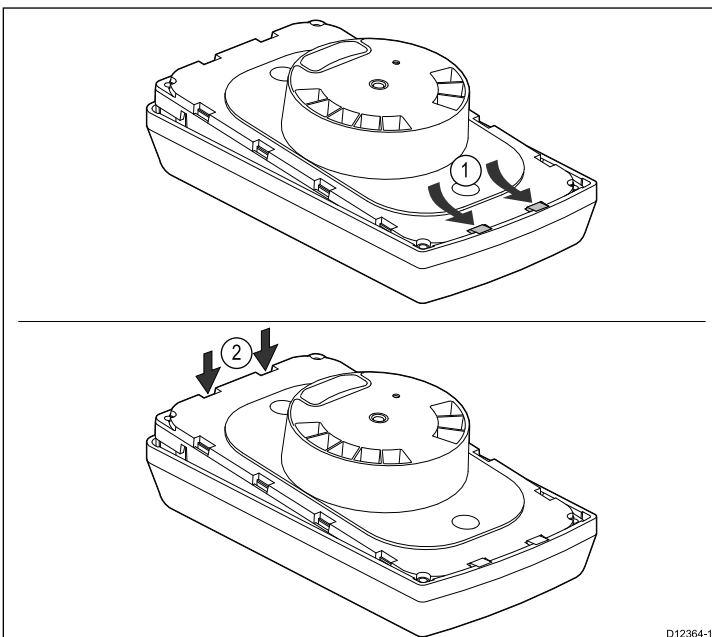

1. Ensure the keymat is positioned correctly.
2. Fit the unit into the bezel so that the unit slides under the lugs on the bezel, as shown in 1.

3. Gently but firmly press the bezel onto the unit until it clicks into place, as shown in 2.
4. Follow the mounting instructions to refit the unit on to the mounting surface.

SWIB

Chapter 6: Getting started

Chapter contents

- [6.1 Controls on page 30](#)
- [6.2 Power on page 30](#)
- [6.3 Data master on page 31](#)
- [6.4 Adjusting the backlight on page 31](#)
- [6.5 Adjusting the contrast on page 32](#)
- [6.6 Calibration on page 32](#)

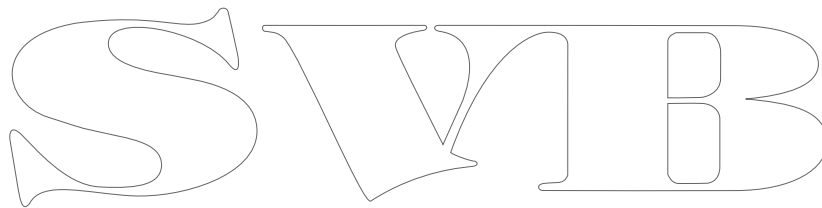
A large, stylized outline logo for 'SWIB'. The letters are thick and have a decorative, slightly calligraphic feel. The 'S' is on the left, followed by 'W', 'I', and 'B' on the right. The logo is centered horizontally on the page.

6.1 Controls

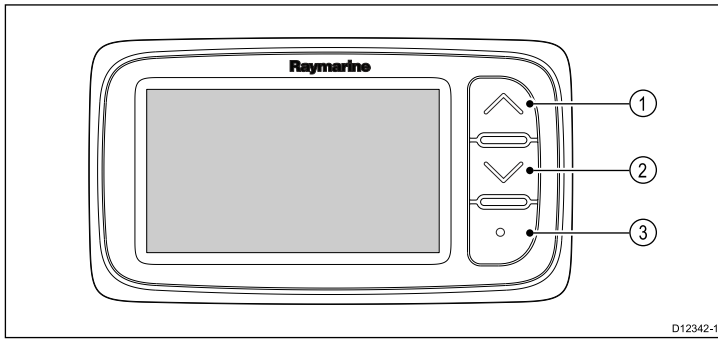

1	Up
2	Down
3	Action

6.2 Power

Once the power supply is connected and turned on the unit will power up. When the power supply is switched off the unit will power off.

SVIB

6.3 Data master

Where a system contains more than one unit capable of displaying a data type (e.g. depth can be displayed on the i40 Depth and i40 Bidata), the unit physically connected to the transducer must be set as the data master and any other units set as a repeater.

Setting a unit as data master

1. Simultaneously press and hold the **Down** and **Action** buttons for 4 seconds.

The software version page is displayed.

2. Press the **Action** button to display the instrument status.

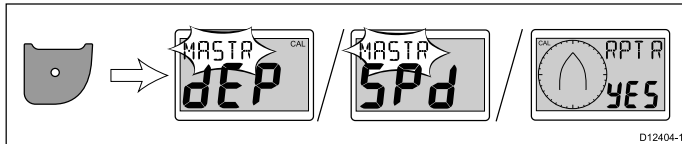

Note: The i40 Bidata requires an extra **Action** button push to switch from depth instrument status and speed instrument status.

3. Use the **Up** and **Down** buttons to change the instrument status between Master and Repeater.
4. To save your settings and return to normal operation from any page, simultaneously press and hold the **Down** and **Action** buttons for 2 seconds.

6.4 Adjusting the backlight

The backlighting can be adjusted using the **Action** button.

During normal operation:

1. Press and hold the **Action** button for 1 second.
The current backlighting level is displayed.
2. Press the **Action** button again to cycle through the available backlight settings.
3. To return to normal operation press the **Up** or **Down** button, or wait for the 5 second time-out.
4. Alternatively press and hold the **Action** button for 1 second to adjust the contrast.

SVIB

6.5 Adjusting the contrast

The contrast can be adjusted using the **Action** button.

During normal operation:

1. Press and hold the **Action** button for 2 seconds, or from the backlight level screen press and hold the **Action** button for 1 second.
The current contrast level is displayed.
2. Press the **Action** button again to cycle through the available contrast settings.
3. To return to normal operation press the **Up** or **Down** button, or wait for the 5 second time-out.

6.6 Calibration

Before first use calibration procedures must be carried out to ensure optimum performance of the instrument with the vessel.

The calibration procedures are:

- User calibration
- Intermediate calibration
- Group setup
- Dealer calibration

Note: Group setup is for group illumination and is not part of the calibration process.

User calibration

Calibration procedures are dependant on instrument display variant.

User calibration options include:

i40 Bidata	i40 Depth	i40 Speed	i40 Wind
Setting the depth display response.	Setting the depth display response.	Setting the speed display response.	Setting the wind angle and speed response values.
Setting the speed display response.	*Setting the required units for depth readings.	*Setting required units for speed readings.	Setting the required wind speed units.
*Setting the required units for depth readings.	*Setting the required depth offset.	*Setting the required units for distance readings.	*Linearize and align rotavecta.
*Setting required units for speed readings.	*Locking the shallow alarm.	*Setting required units for water temperature.	
*Setting the required units for distance readings.		*Setting the correct speed reading.	
*Setting required units for water temperature.			
*Setting the correct speed reading.			
*Setting the required depth offset.			
*Locking the shallow alarm.			

Note: *These settings are only available on units with the instrument status set to Master (see Intermediate Calibration for details).

Depth Offset

Depths are measured from the transducer to the sea bed, but you can apply an offset value to the depth data, so that the displayed depth reading represents the depth to the sea bed from either the keel or the water-line.

Before attempting to set a waterline or keel offset, find out the vertical separation between the transducer and either the waterline or the bottom of the keel on your vessel, as appropriate. Then set the appropriate depth offset value.

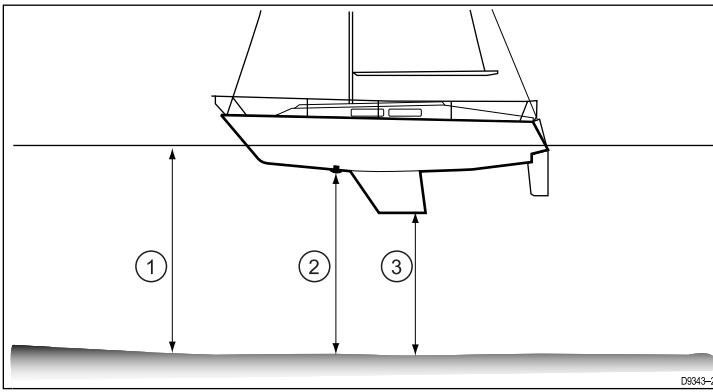

1	Waterline offset
2	Transducer / Zero offset
3	Keel offset

If an offset is not applied, displayed depth readings represent the distance from the transducer to the sea bed.

Calibrating Bidata

To calibrate your i40 Bidata follow the steps below.

During normal operation:

1. Simultaneously press and hold the **Down** and **Action** buttons for 2 seconds to display the user cal page.

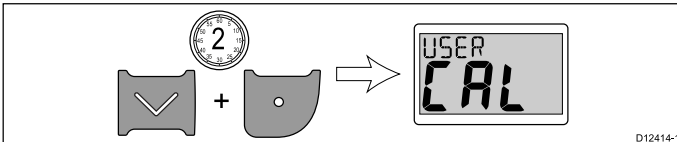

2. Press the **Action** button to display the depth response page.

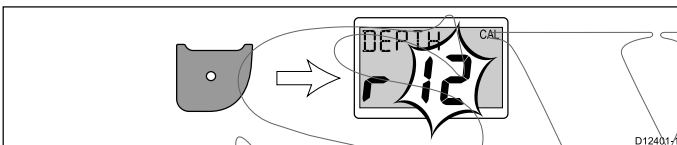

3. Use the **Up** and **Down** buttons to adjust the depth response to the required level.

4. Press the **Action** button to display the speed response page.

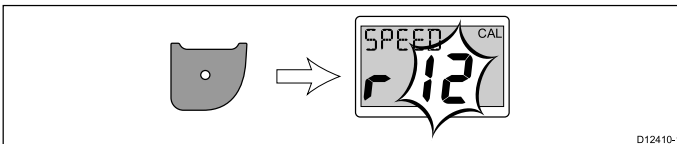

5. Use the **Up** and **Down** buttons to adjust the speed response to the required level.

6. Press the **Action** button to display the depth units page.

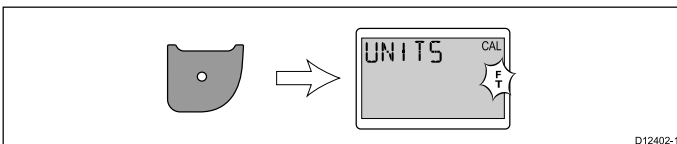

7. Use the **Up** and **Down** buttons to select the required depth units.

8. Press the **Action** button to display the speed units page.

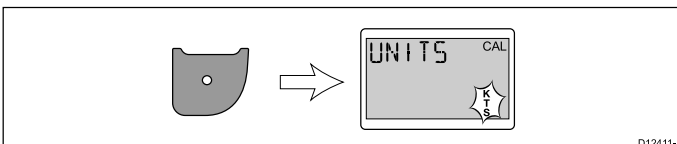

9. Use the **Up** and **Down** buttons to select the required speed units.

10. Press the **Action** button to display the distance units page.

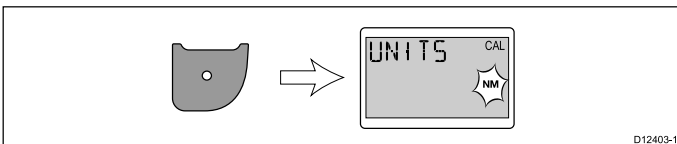

11. Use the **Up** and **Down** buttons to select the required distance units.

12. Press the **Action** button to display the water temperature units page.

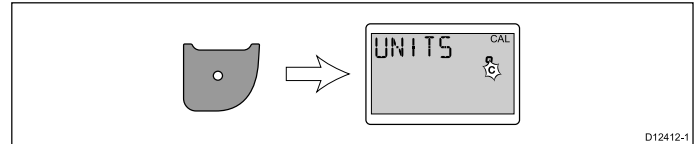

13. Use the **Up** and **Down** buttons to select the required temperature units.

14. Press the **Action** button to display to the cal factor page.

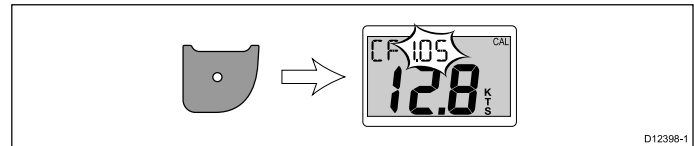

15. Use the **Up** button to increase the cal factor value, or the **Down** button to decrease the cal factor value.

16. Alternatively, simultaneously press and hold the **Up** and **Down** buttons to display the SOG page.

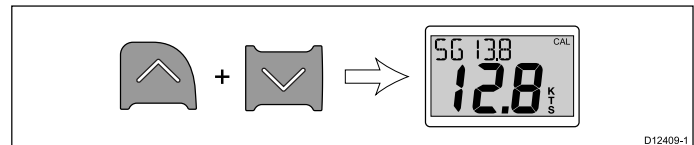

The SOG page is only displayed if SOG data is available and the vessel speed is greater than 0.5 kts.

17. In conditions of zero tide and current, press the **Up** button for 3 seconds to apply the SOG value as the speed reading.

18. Press the **Action** button to display the depth offset page.

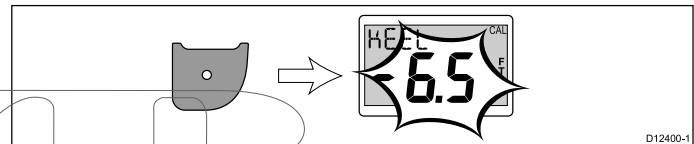

19. Use the **Up** and **Down** buttons to select the required depth offset value.

20. Press the **Action** button to display the shallow alarm lock page.

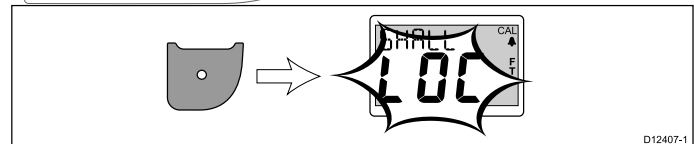

21. Use the **Up** and **Down** buttons to switch the shallow alarm lock on and off.

22. To save your settings and return to normal operation from any page, simultaneously press and hold the **Down** and **Action** buttons for 2 seconds.

Calibrating depth

To calibrate your i40 Depth follow the steps below.

During normal operation:

1. Simultaneously press and hold the **Down** and **Action** buttons for 2 seconds to display the user cal page.

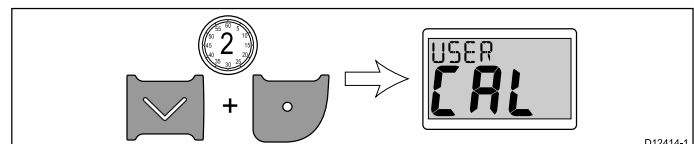

2. Press the **Action** button to display the depth response page.

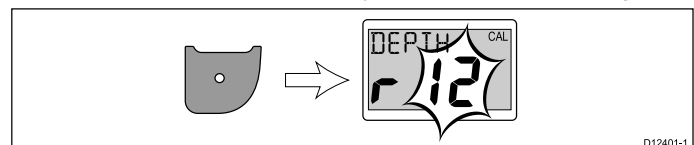

3. Use the **Up** and **Down** buttons to adjust the depth response to the required level.

- Press the **Action** button to display the depth units page.

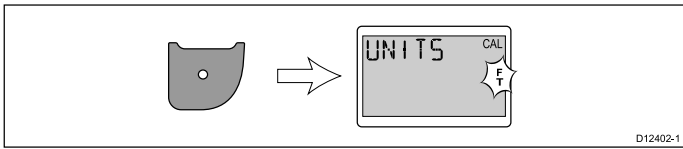

- Use the **Up** and **Down** buttons to select the required depth units.
- Press the **Action** button to display the depth offset page.

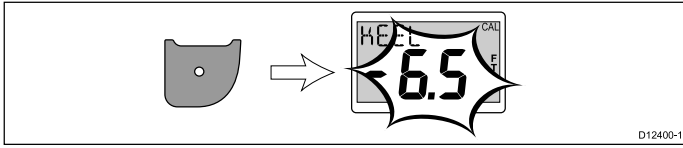

- Use the **Up** and **Down** buttons to select the required depth offset value.
- Press the **Action** button to display the shallow alarm lock page.

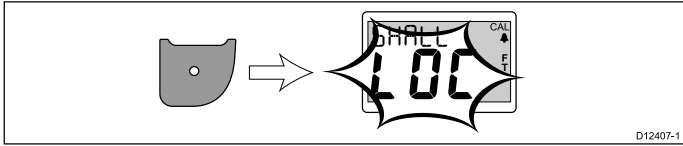

- Use the **Up** and **Down** buttons to switch the shallow alarm lock on and off.
- To save your settings and return to normal operation from any page, simultaneously press and hold the **Down** and **Action** buttons for 2 seconds.

Calibrating speed

To calibrate your i40 Speed follow the steps below.

During normal operation:

- Simultaneously press and hold the **Down** and **Action** buttons for 2 seconds to display the user cal page.

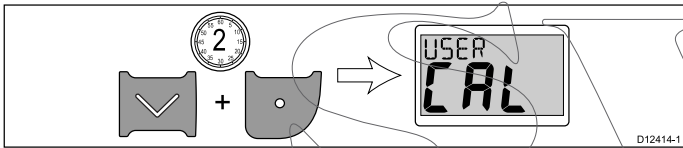

- Press the **Action** button to display the speed response page.

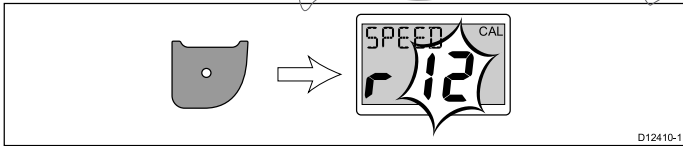

- Use the **Up** and **Down** buttons to adjust the speed response to the required level.
- Press the **Action** button to display the speed units page.

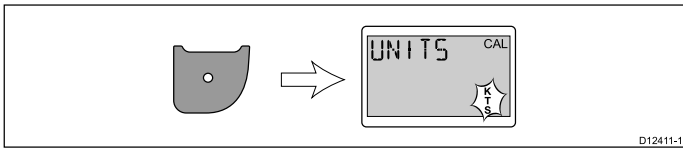

- Use the **Up** and **Down** buttons to select the required speed units.
- Press the **Action** button to display the distance units page.

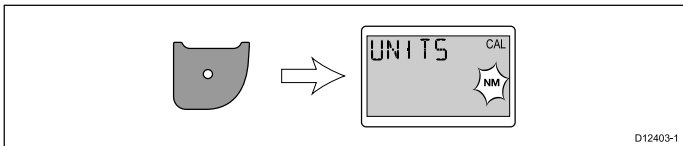

- Use the **Up** and **Down** buttons to select the required distance units.
- Press the **Action** button to display the water temperature units page.

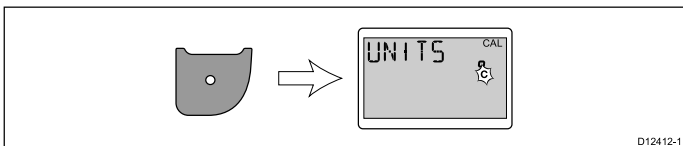

- Use the **Up** and **Down** buttons to select the required temperature units.

- Press the **Action** button to display the cal factor page.

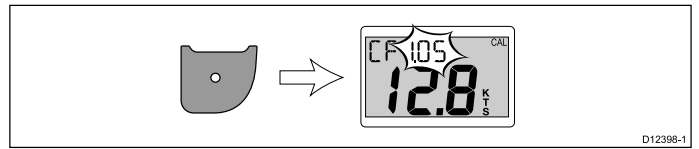

- Use the **Up** button to increase the cal factor value, or the **Down** button to decrease the cal factor value.
- Alternatively, simultaneously press and hold the **Up** and **Down** buttons to display the SOG page.

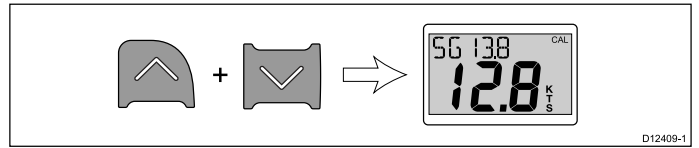

The SOG page is only displayed if SOG data is available and the vessel speed is greater than 0.5 kts.

- In conditions of zero tide and current, press the **Up** button for 3 seconds to apply the SOG value as the speed reading.
- To save your settings and return to normal operation from any page, simultaneously press and hold the **Down** and **Action** buttons for 2 seconds.

Calibrating wind

You will need to be underway, with sufficient space to turn in a large slow circle unhindered. Conditions should be calm (i.e. a slight sea) and a steady breeze. Try to ensure the vessel is not rolling or pitching too much. During normal operation:

- Simultaneously press and hold the **Down** and **Action** buttons for 2 seconds to display the user cal page.

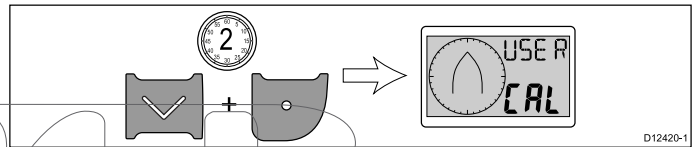

- Press the **Action** button to display the set wind angle response page.

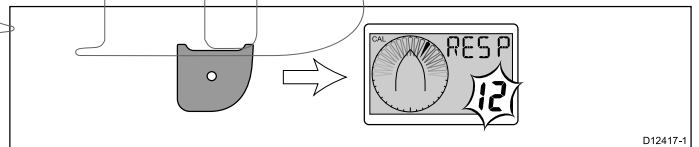

- Use the **Up** and **Down** buttons to adjust the wind angle response to the required level.
- Press the **Action** button to display the set wind speed response page.

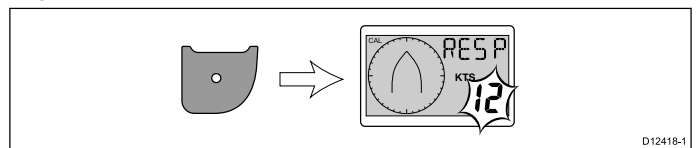

- Use the **Up** and **Down** buttons to adjust the wind speed response to the required level.
- Press the **Action** button to display the set wind speed units page.

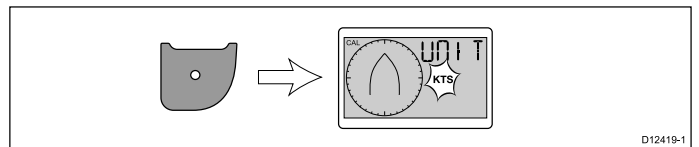

- Use the **Up** and **Down** buttons to select the required wind speed units.
- Press the **Action** button to display the linearize transducer page.

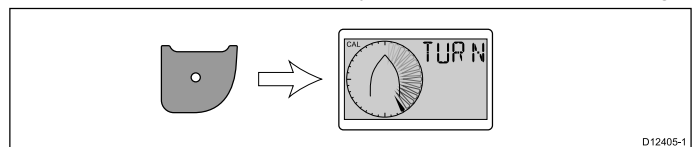

Note: If 5pd is displayed on the linearize transducer page the wind speed is outside of the range suitable for linearization.

- Keep the vessel speed below 2 kts and begin to turn the vessel in a circle.
- Press the **Up** button to begin linearization.
- You will be required to perform a minimum of 2 complete circles.

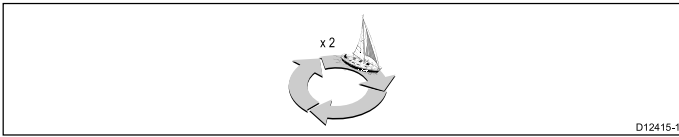

An alarm will sound upon successful completion.

- After linearization the align transducer page is displayed. Use the **Up** button to increase the alignment angle and the **Down** button to decrease the alignment angle.

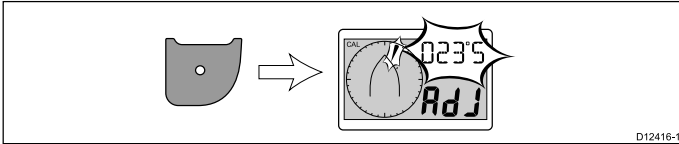

- To save your settings and return to normal operation from any page, simultaneously press and hold the **Down** and **Action** buttons for 2 seconds.

Intermediate calibration

Intermediate calibration allows you to:

- Check the instrument software version.
- Check and if necessary set the instrument status as either Master or Repeater.

Checking software version and instrument status

During normal operation:

1. Simultaneously press and hold the **Down** and **Action** buttons for 4 seconds to display the software version.

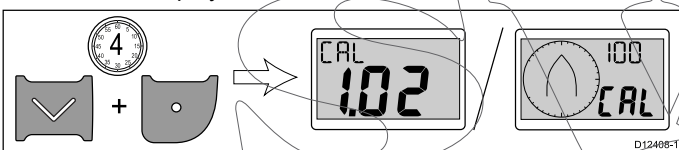

2. Press the **Action** button to display the instrument status.

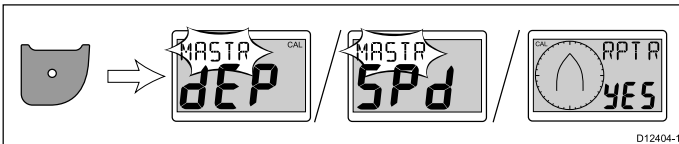

Note: The i40 Bidata requires an extra Action button push to switch from depth instrument status and speed instrument status.

3. Use the **Up** and **Down** buttons to change the instrument status between Master and Repeater.
4. To save your settings and return to normal operation from any page, simultaneously press and hold the **Down** and **Action** buttons for 2 seconds.

Dealer calibration

Dealer calibration enables you to set:

- User calibration on / off.
- Boat show mode on / off.
- Reset factory defaults.

Changing dealer calibration settings

During normal operation:

1. Simultaneously press and hold the **Down** and **Action** buttons for 12 seconds to display the dealer calibration page.

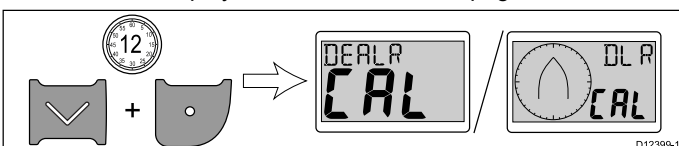

2. Press the **Action** button to display the user calibration access page.

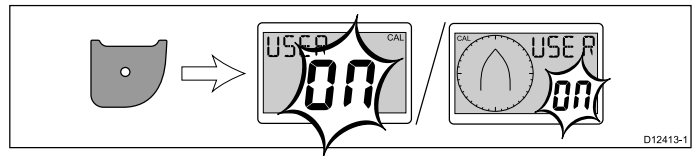

3. Use the **Up** and **Down** buttons to switch the User calibration on and off.

Selecting off will disable the user calibration pages.

4. Press the **Action** button to display the boat show mode page.

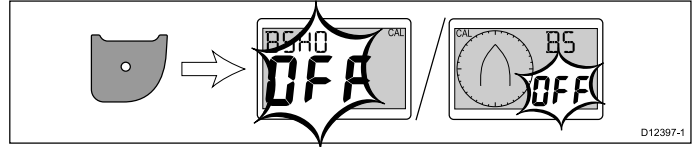

5. Use the **Up** and **Down** buttons to switch boat show mode on and off.

Selecting on will put the display into boat show mode.

Note: Boat show mode is only suitable for demonstration purposes and should NOT be used whilst your vessel is in use.

6. Press the **Action** button to display the Factory defaults page.



7. To reset your display to factory default settings, use the **Up** or **Down** buttons to change the reset option to Yes.
8. Press the **Action** button to reset your display to factory defaults or return to the user calibration access page.
9. To save your settings and return to normal operation from any page, simultaneously press and hold the **Down** and **Action** buttons for 2 seconds.

SWIB

Chapter 7: Using your display

Chapter contents

- [7.1 Pages on page 38](#)
- [7.2 i40 Bidata operation on page 38](#)
- [7.3 i40 Depth operation on page 40](#)
- [7.4 i40 Speed operation on page 41](#)
- [7.5 i40 Wind operation on page 42](#)

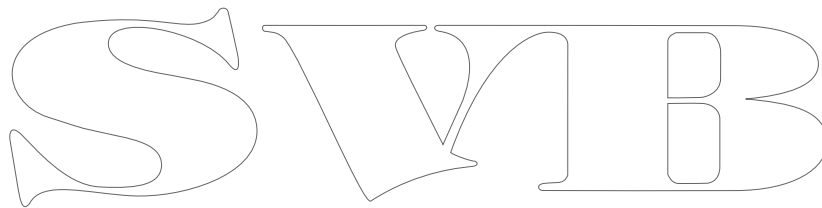
The image shows the letters 'SWIB' in a large, stylized, outlined font. The letters are white with a thin black outline. The 'S' is a simple, rounded shape. The 'W' is composed of two 'V' shapes joined at the top. The 'I' is a simple vertical bar. The 'B' is a simple, rounded shape with a vertical bar in the middle.

7.1 Pages

When the unit is switched on the page displayed at last switch off will be displayed.

The pages available depend on the display variant and are shown in the table below:

i40 Bidata	i40 Depth	i40 Speed	i40 Wind
Current depth / speed	Current depth	Current speed	Apparent wind
Maximum speed*	Minimum depth*	Maximum speed*	True wind
Average speed*	Shallow alarm*	Average speed*	High wind speed alarm*
Log*	Deep alarm*	Log*	
Trip*	Shallow anchor alarm*	Trip*	
Water temperature	Deep anchor alarm*	Water temperature	
Minimum depth*	Depth offset*		
Shallow alarm*			
Deep alarm*			
Shallow anchor alarm*			
Deep anchor alarm*			
Depth offset*			

Note: *These pages are temporary pages and will revert to the previous permanent page after 5 seconds.

Changing pages

During normal operation:

1. Press the **Up** or **Down** buttons to cycle through the available pages.

7.2 i40 Bidata operation

When connected to the relevant transducer(s) your i40 Bidata instrument:

- Provides speed information (current, maximum and average), in either knots (KTS), miles per hour (MPH) or kilometers per hour (KPH).
- Provides log and trip information. These are given in either nautical miles (NM), statute miles (M) or kilometers (KM).
- Provides water temperature information. This is given in either degrees celsius (°C) or degrees fahrenheit (°F).
- Provides depth information in either feet (FT), metres (M) or fathoms (FA).
- Records the minimum depth encountered during the period the unit is switched on. This can be reset at any time.
- Enables you to define alarm thresholds for shallow alarm, deep alarm, shallow anchor alarm and deep anchor alarm.
- Enables you to see what offset is applied to the depth reading.

Note: The required speed, distance, depth and water temperature units are selected during User calibration.

It should be noted that:

- Up / Down depth-trend arrows are displayed, if the seabed is rising or falling at a significant rate.
- The log screen shows the total distance covered by the vessel since the unit was fitted.
- Minimum depth, maximum speed, average speed and trip reading are reset to zero at power up.

i40 Bidata Display

The display is split into upper and lower data areas, each of which shows either depth or speed information, depending on user selection.

The **Current speed**, **Current depth** and **Current water temperature** pages are permanent pages, all other pages are temporary and will time-out after 5 seconds, to the last permanent page displayed.

Switching the depth and speed position

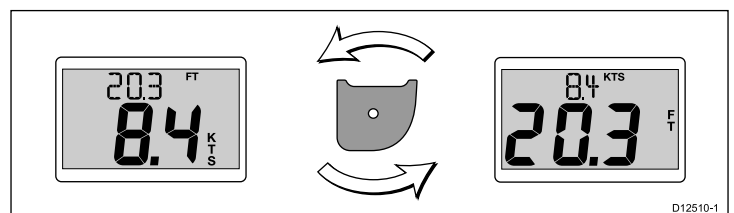

1. Press the **Action** button to switch speed and depth positions on the display.

Using the speed pages

To cycle through the speed pages follow the steps below:

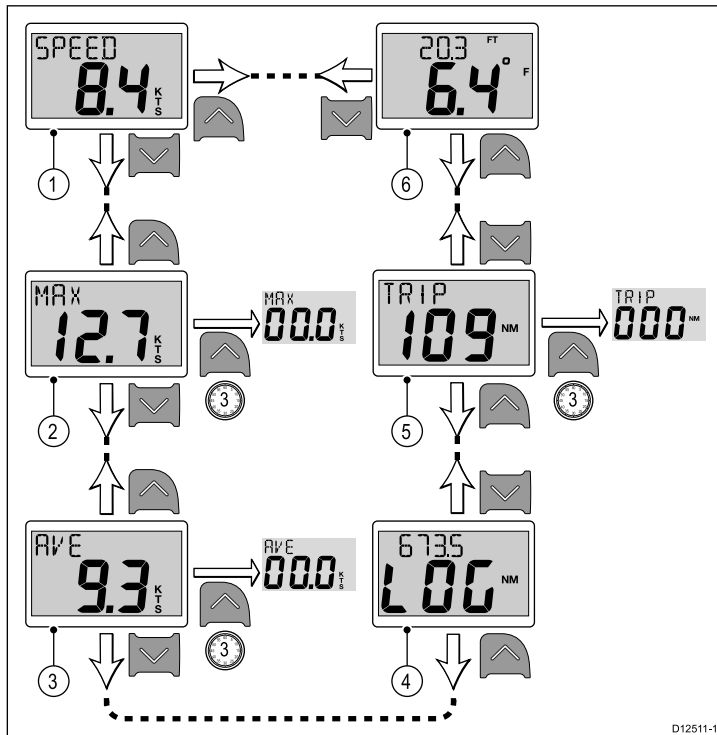

Note: The trip distance reading can only be reset if the unit's status is set to Master (See the *Data master* section for details).

1. With the **Current speed** page displayed:
 - i. Press the **Up** button to display the **Water temperature** page, or
 - ii. Press the **Down** button to display the **Maximum speed** page.
2. With the **Maximum speed** page displayed:
 - i. Press the **Up** button to display the **Current speed** page, or
 - ii. Press the **Down** button to display the **Average speed** page, or
 - iii. Press and hold the **Up** button for 3 seconds to reset the maximum speed reading.
3. With the **Average speed** page displayed:
 - i. Press the **Up** button to display the **Maximum speed** page, or
 - ii. Press the **Down** button to display the **Log** page, or
 - iii. Press and hold the **Up** button for 3 seconds to reset the average speed reading.
4. With the **Log** page displayed:
 - i. Press the **Up** button to display the **Average speed** page, or
 - ii. Press the **Down** button to display the **Trip** page.
5. With the **Trip** page displayed:
 - i. Press the **Up** button to display the **Log** page, or
 - ii. Press the **Down** button to display the **Current water temperature** page, or
 - iii. Press and hold the **Up** button for 3 seconds to reset the trip reading.
6. With the **Current water temperature** page displayed:
 - i. Press the **Up** button to display the **Trip** page, or
 - ii. Press the **Down** button to display the **Current speed** page.

Note: Only the **Current speed** and **Current water temperature** pages are permanent pages, all other pages will time out after 5 seconds and revert back to the last permanent page displayed.

Using the depth pages

To cycle through the depth pages follow the steps below:

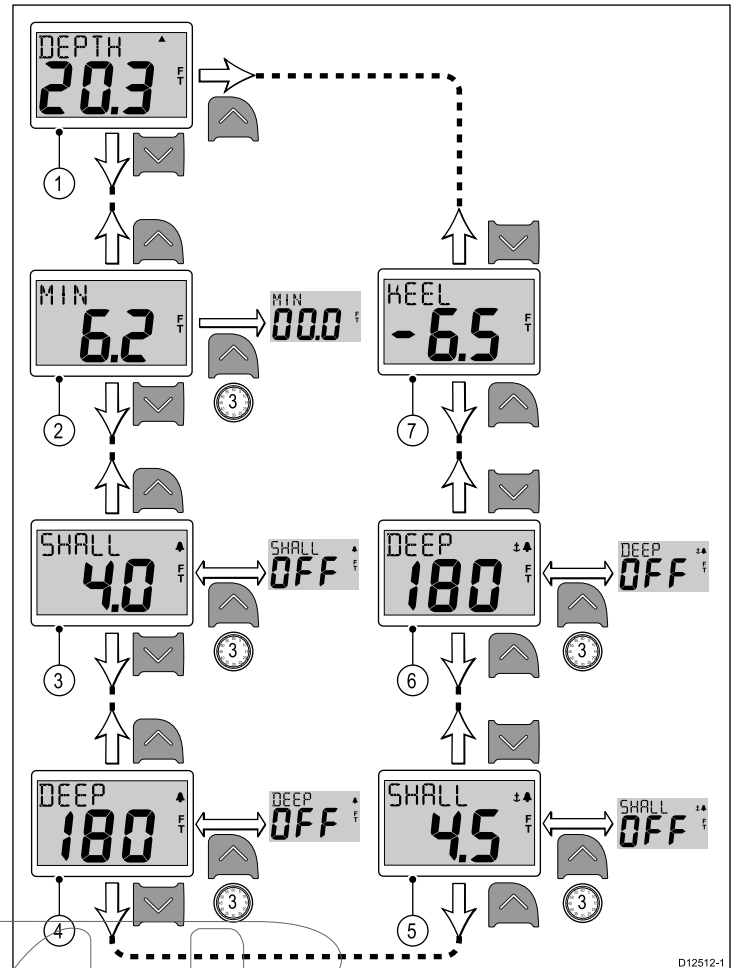

Note: Alarm and offset pages are only available if the unit's status is set to Master (See the *Data master* section for details).

1. With the **Current depth** page displayed:
 - i. Press the **Up** button to display the **Depth offset** page, or
 - ii. Press the **Down** button to display the **Minimum depth** page.
2. With the **Minimum depth** page displayed:
 - i. Press the **Up** button to display the **Current depth** page, or
 - ii. Press the **Down** button to display the **Shallow alarm** page, or
 - iii. Press and hold the **Up** button for 3 seconds to reset the minimum depth reading to zero.
3. With the **Shallow alarm** page displayed:
 - i. Press the **Up** button to display the **Minimum depth** page, or
 - ii. Press the **Down** button to display the **Deep alarm** page, or
 - iii. Press and hold the **Up** button for 3 seconds to switch the shallow alarm on and off.
4. With the **Deep alarm** page displayed:
 - i. Press the **Up** button to display the **Shallow alarm** page, or
 - ii. Press the **Down** button to display the **Shallow anchor alarm** page, or
 - iii. Press and hold the **Up** button for 3 seconds to switch the deep alarm on and off.
5. With the **Shallow anchor alarm** page displayed:
 - i. Press the **Up** button to display the **Deep alarm** page, or
 - ii. Press the **Down** button to display the **Deep anchor alarm** page, or
 - iii. Press and hold the **Up** button to switch the shallow anchor alarm on and off.
6. With the **Deep anchor alarm** page displayed:
 - i. Press the **Up** button to display the **Shallow anchor alarm** page, or
 - ii. Press the **Down** button to display the **Depth offset** page, or
 - iii. Press and hold the **Up** button to switch the deep anchor alarm on and off.
7. With the **Depth offset** page displayed:

- i. Press the **Up** button to display the **Deep anchor alarm** page, or
- ii. Press the **Down** button to display the **Current depth** page.

Note: Only the **Current depth** page is a permanent page, all other pages will time out after 5 seconds and revert back to the last permanent page displayed.

7.3 i40 Depth operation

When connected to the relevant depth transducer, your i40 depth instrument:

- Provides depth information, in either feet (ft), metres (M) or fathoms (FA).
- Records the minimum depth encountered during the period the unit is switched on.
- Enables you to define alarm thresholds for shallow alarm, deep alarm, shallow anchor alarm and deep anchor alarm.
- Enables you to see what offset has been applied to the depth reading.

Note: The required depth units are selected during User calibration.

It should be noted that:

- Up / Down depth-trend arrows are displayed, if the seabed is rising or falling at a significant rate.
- Minimum depth reading is reset to zero at power up.

Using the depth pages

To cycle through the depth pages follow the steps below:

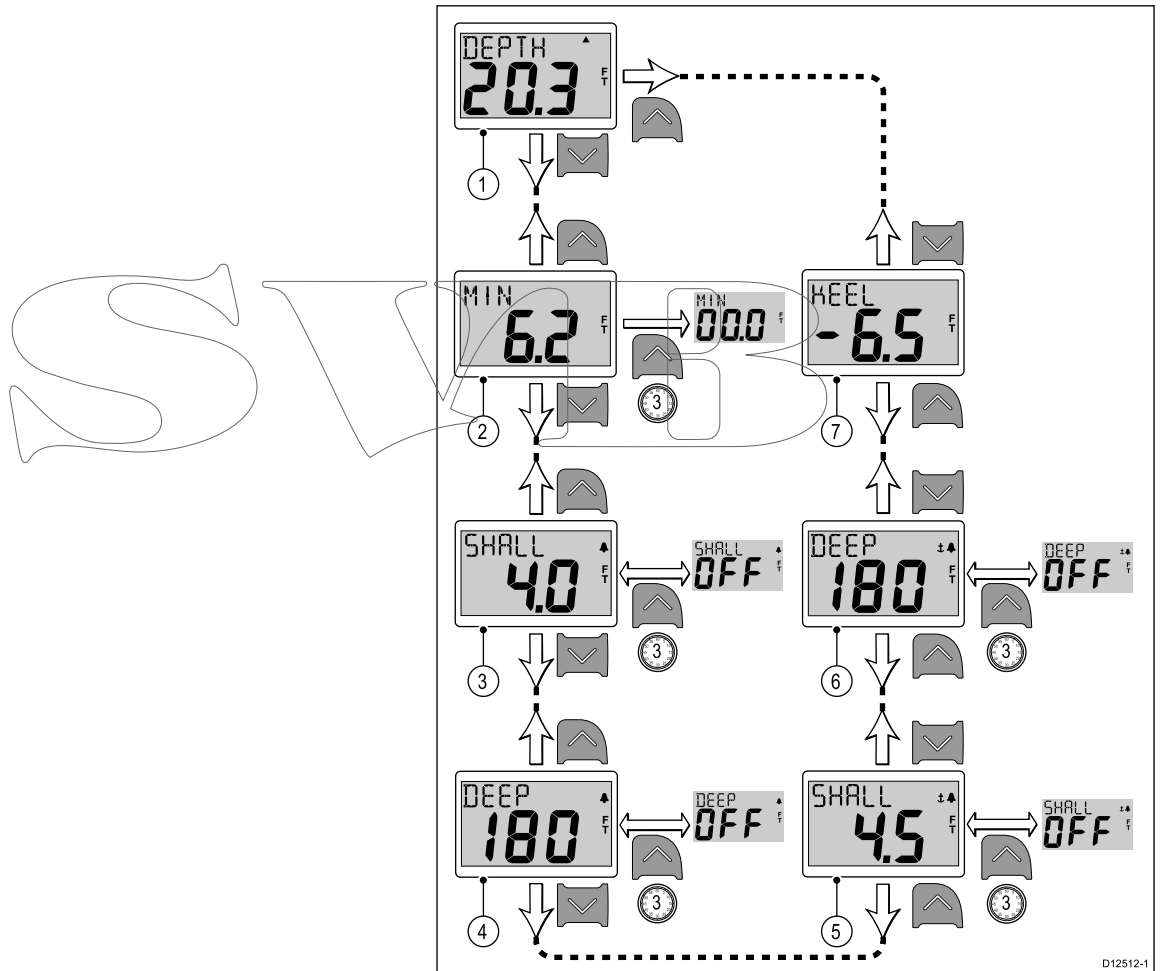

Note: Alarm and offset pages are only available if the unit's status is set to Master (See the *Data master* section for details).

1. With the **Current depth** page displayed:
 - i. Press the **Up** button to display the **Depth offset** page, or
 - ii. Press the **Down** button to display the **Minimum depth** page.
2. With the **Minimum depth** page displayed:
 - i. Press the **Up** button to display the **Current depth** page, or
 - ii. Press the **Down** button to display the **Shallow alarm** page, or
 - iii. Press and hold the **Up** button for 3 seconds to reset the minimum depth reading to zero.
3. With the **Shallow alarm** page displayed:
 - i. Press the **Up** button to display the **Minimum depth** page, or
 - ii. Press the **Down** button to display the **Deep alarm** page, or

- iii. Press and hold the **Up** button for 3 seconds to switch the shallow alarm on and off.
4. With the **Deep alarm** page displayed:
 - i. Press the **Up** button to display the **Shallow alarm** page, or
 - ii. Press the **Down** button to display the **Shallow anchor alarm** page, or
 - iii. Press and hold the **Up** button for 3 seconds to switch the deep alarm on and off.
5. With the **Shallow anchor alarm** page displayed:
 - i. Press the **Up** button to display the **Deep alarm** page, or
 - ii. Press the **Down** button to display the **Deep anchor alarm** page, or
 - iii. Press and hold the **Up** button to switch the shallow anchor alarm on and off.
6. With the **Deep anchor alarm** page displayed:
 - i. Press the **Up** button to display the **Shallow anchor alarm** page, or
 - ii. Press the **Down** button to display the **Depth offset** page, or
 - iii. Press and hold the **Up** button to switch the deep anchor alarm on and off.
7. With the **Depth offset** page displayed:
 - i. Press the **Up** button to display the **Deep anchor alarm** page, or
 - ii. Press the **Down** button to display the **Current depth** page.

7.4 i40 Speed operation

When connected to the relevant speed or speed and temperature transducer, your i40 Speed instrument provides:

- Current, maximum and average speed information, in either knots (KTS), mile per hour (MPH) or kilometers per hour (KPH).
- Log and trip information, in either nautical miles (NM), statute miles (M) or kilometers (KM).
- Water temperature information, in either degrees celsius (°C) or fahrenheit (°F).

Note: The required speed, distance and temperature units are selected during User calibration.

It should be noted that:

- The maximum speed, average speed and trip reading are reset to zero at power up.
- The log screen shows the total distance covered by the vessel since the unit was fitted.

Using the speed pages

To cycle through the speed pages follow the steps below:

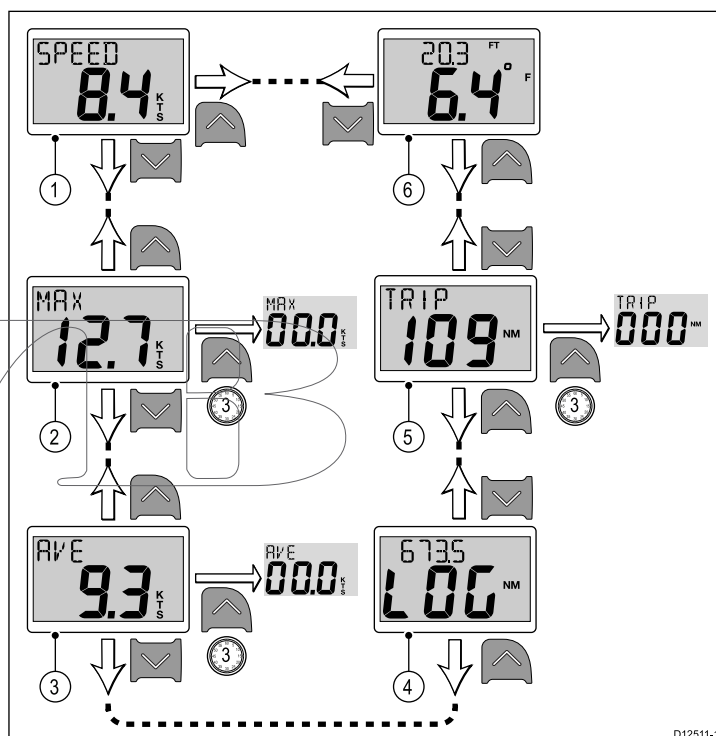

Note: The trip distance reading can only be reset if the unit's status is set to Master (See the *Data master* section for details).

1. With the **Current speed** page displayed:
 - i. Press the **Up** button to display the **Water temperature** page, or
 - ii. Press the **Down** button to display the **Maximum speed** page.
2. With the **Maximum speed** page displayed:
 - i. Press the **Up** button to display the **Current speed** page, or
 - ii. Press the **Down** button to display the **Average speed** page, or
 - iii. Press and hold the **Up** button for 3 seconds to reset the maximum speed reading.
3. With the **Average speed** page displayed:
 - i. Press the **Up** button to display the **Maximum speed** page, or
 - ii. Press the **Down** button to display the **Log** page, or
 - iii. Press and hold the **Up** button for 3 seconds to reset the average speed reading.
4. With the **Log** page displayed.
 - i. Press the **Up** button to display the **Average speed** page, or
 - ii. Press the **Down** button to display the **Trip** page.
5. With the **Trip** page displayed:
 - i. Press the **Up** button to display the **Log** page, or

- ii. Press the **Down** button to display the **Current water temperature** page, or
 - iii. Press and hold the **Up** button for 3 seconds to reset the trip reading.
6. With the **Current water temperature** page displayed:
- i. Press the **Up** button to display the **Trip** page, or
 - ii. Press the **Down** button to display the **Current speed** page.

Note: Only the **Current speed** and **Current water temperature** pages are permanent pages, all other pages will time out after 5 seconds and revert back to the last permanent page displayed.

7.5 i40 Wind operation

When connected to a rotavecta transducer, your i40 Wind instrument:

- Provides apparent wind speed and direction information, in either knots (KTS), or metres per second (M/S).
- Provides true wind speed and direction information, if vessel speed information is available on SeaTalk.
- Enables a locked apparent wind angle, which is defined either manually or automatically by a course computer. In this mode, the unit shows the deviations from the locked wind angle and the direction to steer to achieve the locked wind angle.

True and apparent wind pages

Apparent and True wind pages

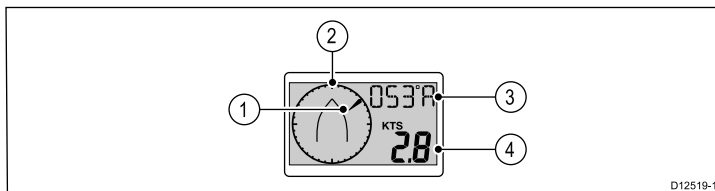

1	Wind direction with respect to vessel heading, either apparent or true.
2	Vessel heading.
3	Wind angle, either A (apparent) or T (True).
4	Wind speed, either apparent or true, as indicated in item 3.

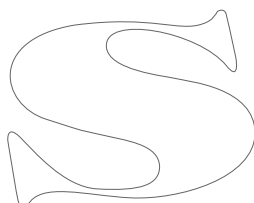

Locked apparent wind page

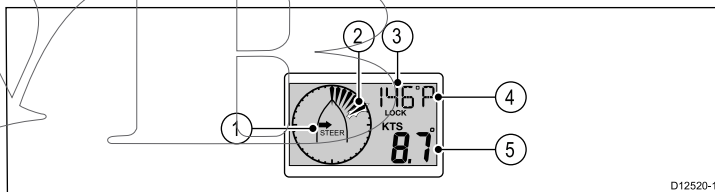

Note: If **A LOCK** is displayed the wind angle is controlled by the course computer and cannot be changed manually.

1	Direction to steer indicator, to achieve locked wind angle.
2	Flashing segment indicates the divergence of the apparent wind from the locked wind angle.
3	Locked wind angle.
4	Relative direction of the locked wind angle: <ul style="list-style-type: none"> • P = Port. • S = Starboard.
5	Apparent wind speed.

Using the wind pages

To cycle through the wind pages follow the steps below:

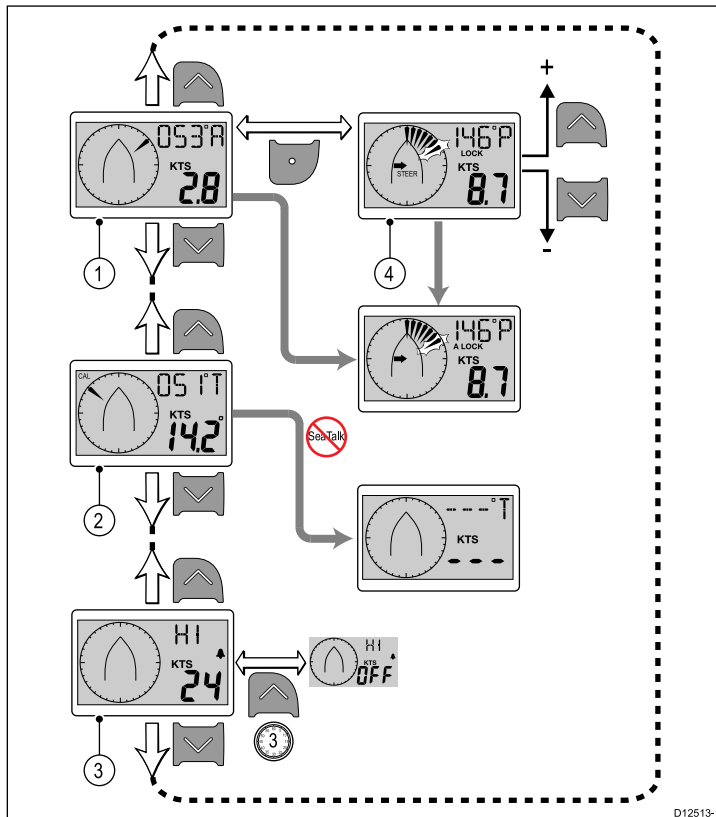

Note: The **High wind speed alarm** page is only available on master units (See the *Data master* section for details), it is a temporary page which will time out after 5 seconds to the previous permanent page.

1. With the **Apparent wind** page displayed:
 - i. Press the **Up** button to display the **High wind speed alarm** page, or
 - ii. Press the **Down** button to display the **True wind** page, or
 - iii. Press the **Action** button to apply the current wind bearing as the locked heading and display the **Locked apparent wind angle** page.
2. With the **True wind** page displayed:
 - i. Press the **Up** button to display the **Apparent wind** page, or
 - ii. Press the **Down** button to display the **High wind speed alarm** page.
3. With the **High wind speed alarm** page displayed:
 - i. Press the **Up** button to display the **True wind** page, or
 - ii. Press the **Down** button to display the **Apparent wind** page.
4. With the **Locked apparent wind angle** page displayed:
 - i. Use the **Up** and **Down** buttons to adjust the locked wind angle, or
 - ii. Press the **Action** button to return to the **Apparent wind** page

SWIB

Chapter 8: Using alarms

Chapter contents

- [8.1 Alarms on page 46](#)

SWIB

8.1 Alarms

Alarms alert you to a situation or hazard requiring your attention.

You can set up alarms to alert you to certain conditions.

Alarms are raised by system functions, and also external equipment connected to your display.

When an alarm event occurs an audible and visual alarm is activated which indicates the alarm state.

Alarm thresholds can be configured from the relevant alarm page / menu.

Instrument alarms

The table below shows the alarms available on each instrument display variant.

i40 Bidata	i40 Depth	i40 Speed	i40 Wind
Shallow alarm	Shallow alarm		High wind speed alarm
Deep alarm	Deep alarm		
Shallow anchor alarm	Shallow anchor alarm		
Deep anchor alarm	Deep anchor alarm		

Alarm indications

An alarm event is indicated by both audible and visual warnings.

Shallow alarm

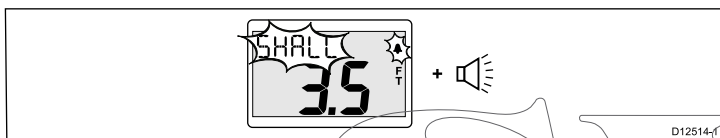

The Shallow alarm is available on both the i40 Bidata and i40 Depth instruments. The Shallow alarm sounds when the depth is equal to or less than the Shallow alarm threshold. The alarm sounds until silenced manually.

Deep alarm

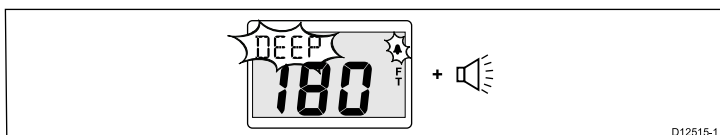

The Deep alarm is available on both the i40 Bidata and i40 Depth instruments. The Deep alarm sounds when the depth is equal to the Deep alarm threshold. The alarm sounds until silenced manually.

Anchor alarms

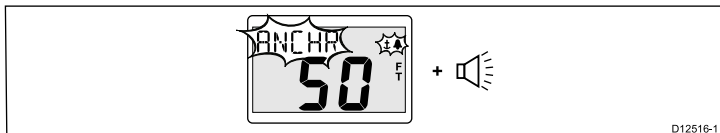

The anchor alarms are available on both the i40 Bidata and i40 Depth instruments. The anchor alarms sound when either:

- Depth is equal to or less than the Shallow anchor alarm threshold, or
- Depth is equal to or more than the Deep anchor alarm threshold.

The alarm sounds until silenced manually.

High wind speed alarm

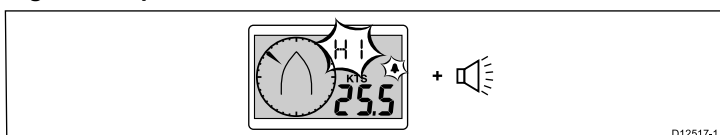

The High wind speed alarm is available on the i40 Wind instrument. The High wind speed alarm sounds when the wind speed exceeds the High wind speed alarm threshold. The alarm sounds until silenced manually.

True wind — If vessel speed information is available at the instrument (from a SeaTalk bus) the alarm is triggered if True wind speed exceeds the threshold.

Apparent wind — If vessel speed information is not present, the alarm is triggered if the Apparent wind speed exceeds the threshold.

Silencing alarms

1. Press any button to silence an active alarm.

Enabling / Disabling alarms

Alarms can be enabled or disabled at any time.

With the relevant alarm page displayed:

1. Press and hold the **Up** button for 3 seconds to switch the alarm on or off.

Setting alarm thresholds

You can adjust the threshold at which alarms are triggered by following the steps below.

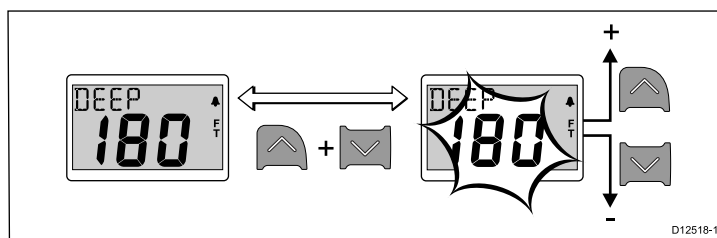

With the relevant alarm page displayed:

1. Press the **Up** and **Down** button simultaneously to enter edit mode.
2. Use the **Up** button to increase the alarm threshold.
3. Use the **Down** button to decrease the alarm threshold.
4. Press the **Up** and **Down** button simultaneously to save the new alarm threshold and exit edit mode.

Note: The illustration above is an example depicting setting the Deep alarm threshold on an i40 Depth instrument.

Chapter 9: Maintaining your display

Chapter contents

- [9.1 Service and maintenance on page 48](#)
- [9.2 Condensation on page 48](#)
- [9.3 Routine equipment checks on page 49](#)
- [9.4 Cleaning on page 49](#)
- [9.5 Cleaning the display case on page 50](#)
- [9.6 Cleaning the display screen on page 50](#)

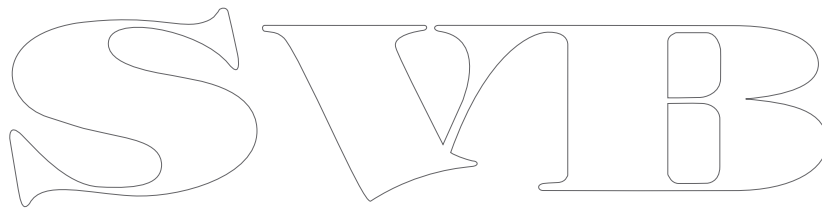

9.1 Service and maintenance

This product contains no user serviceable components. Please refer all maintenance and repair to authorized Raymarine dealers. Unauthorized repair may affect your warranty.

9.2 Condensation

Certain atmospheric conditions may cause a small amount of condensation to form on the unit's window. This will not damage the unit and will clear after the unit has been switched on for a short period.

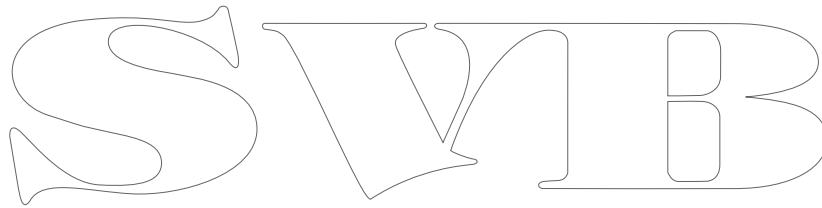

9.3 Routine equipment checks

Raymarine strongly recommends that you complete a number of routine checks to ensure the correct and reliable operation of your equipment.

Complete the following checks on a regular basis:

- Examine all cables for signs of damage or wear and tear.
- Check that all cables are securely connected.

9.4 Cleaning

Best cleaning practices.

When cleaning this product:

- Do NOT wipe the display screen with a dry cloth, as this could scratch the screen coating.
- Do NOT use abrasive, or acid or ammonia based products.
- Do NOT use a jet wash.

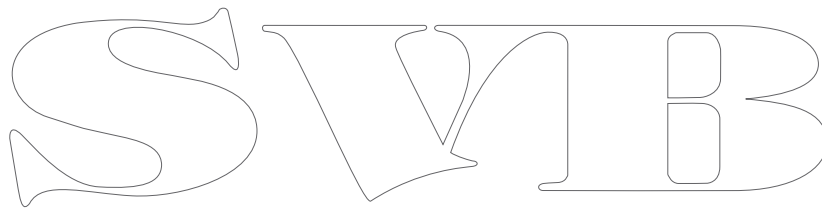
The logo for Raymarine SVMB is displayed in a large, stylized, outlined font. The letters 'S', 'V', and 'M' are connected, and the 'B' is separate. The font has a classic, slightly decorative feel with some serifs.

9.5 Cleaning the display case

The display unit is a sealed unit and does not require regular cleaning. If it is necessary to clean the unit, follow this basic procedure:

1. Switch off the power to the display.
2. Wipe the display with a clean, soft cloth (a microfibre cloth is ideal).
3. If necessary, use isopropyl alcohol (IPA) or a mild detergent to remove grease marks.

Note: Do NOT use IPA or any other solvent or detergent on the screen itself.

Note: In certain conditions, condensation may appear inside the display screen. This will not harm the unit, and can be cleared by powering on the display for a short time.

9.6 Cleaning the display screen

A coating is applied to the display screen. This makes it water repellent, and prevents glare. To avoid damaging this coating, follow this procedure:

1. Switch off the power to the display.
2. Rinse the screen with fresh water to remove all dirt particles and salt deposits.
3. Allow the screen to dry naturally.
4. If any smears remain, very gently wipe the screen with a clean microfibre cleaning cloth (available from an opticians).

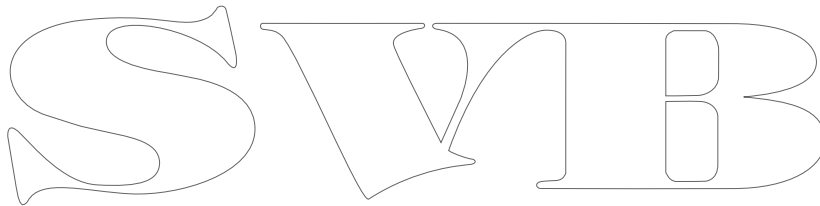
The image shows a stylized outline logo for 'SWIB'. The letters are large, bold, and have a decorative, slightly calligraphic feel. The 'S' is on the left, followed by 'W', 'I', and 'B' on the right. The outlines are thin and black.

Chapter 10: Troubleshooting

Chapter contents

- [10.1 Troubleshooting on page 52](#)
- [10.2 Instrument troubleshooting on page 53](#)
- [10.3 Power up troubleshooting on page 55](#)
- [10.4 Miscellaneous troubleshooting on page 56](#)
- [10.5 Self-test on page 57](#)

SVIB

10.1 Troubleshooting

The troubleshooting information provides possible causes and corrective action required for common problems associated with marine electronics installations.

All Raymarine products are, prior to packing and shipping, subjected to comprehensive test and quality assurance programs. However, if you experience problems with the operation of your product this section will help you to diagnose and correct problems in order to restore normal operation.

If after referring to this section you are still having problems with your unit, please contact Raymarine Technical Support for further advice.

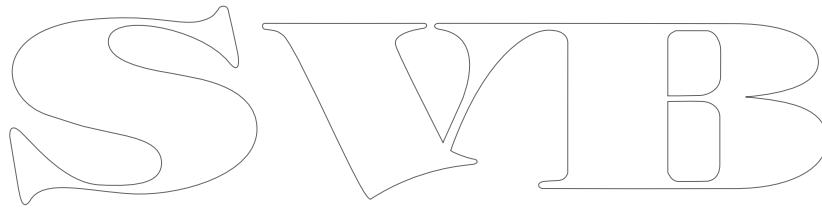
The image shows the letters 'SWIB' in a large, stylized, outlined font. The letters are white with a black outline, set against a plain white background. The 'S' is a simple, rounded shape. The 'W' is formed by two 'V' shapes joined at the top. The 'I' is a simple vertical bar. The 'B' is a simple, rounded shape with a vertical bar in the middle.

10.2 Instrument troubleshooting

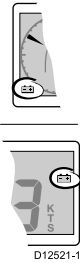
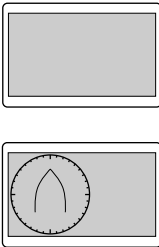
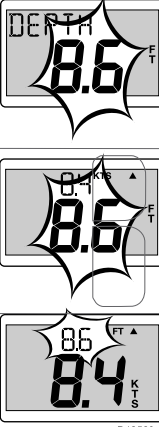
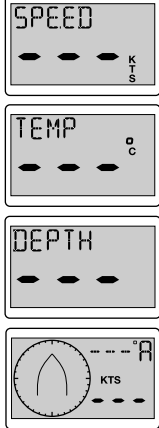
Problem	Applies to	Example screenshots	Action
Low battery.	<ul style="list-style-type: none"> • i40 Bidata • i40 Depth • i40 Speed • i40 Wind 	 <p>D12521-1</p>	<ul style="list-style-type: none"> • Recharge your vessel's battery as soon as possible.
Blank display.	<ul style="list-style-type: none"> • i40 Bidata • i40 Depth • i40 Speed • i40 Wind 	 <p>D12522-1</p>	<ul style="list-style-type: none"> • Check fuse / circuit breaker. • Check power supply. • Check SeaTalk cabling and connector security.
Depth reading flashes when underway.	<ul style="list-style-type: none"> • i40 Bidata • i40 Depth 	 <p>D12523-1</p>	<ul style="list-style-type: none"> • Ensure the reading stabilizes when clear of disturbed water (e.g. vessel wakes, propeller wash etc.).
No data.	<ul style="list-style-type: none"> • i40 Bidata • i40 Depth • i40 Speed • i40 Wind 	 <p>D12524-1</p>	<ul style="list-style-type: none"> • Check the condition of the transducer cable and security of the connections. • Check condition of transducer face and remove any debris. • For i40 wind — if true wind speed information is missing but apparent wind is present then this could be due to no speed information via SeaTalk.

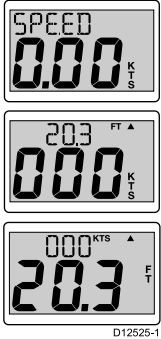
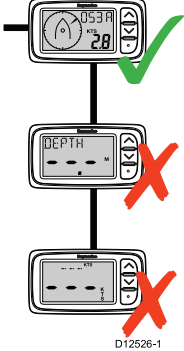
Problem	Applies to	Example screenshots	Action
No speed information but water temperature is present.	<ul style="list-style-type: none"> • i40 Bidata • i40 Speed 		<ul style="list-style-type: none"> • Transducer paddle wheel may be fouled. <p>If you need to remove the transducer insert, have the transducer bung to hand and secure it in the transducer body immediately after the insert is removed, to prevent excessive ingress of water.</p>
SeaTalk information not being transferred between instruments.	<ul style="list-style-type: none"> • i40 Bidata • i40 Depth • i40 Speed • i40 Wind 	For example, backlighting level changes implemented at one unit do not affect other units.	<ul style="list-style-type: none"> • Check security of SeaTalk connections between units. • Check condition of SeaTalk cables. • Isolate faulty unit by disconnecting units one by one.
A group of SeaTalk units not working.	<ul style="list-style-type: none"> • i40 Bidata • i40 Depth • i40 Speed • i40 Wind 		<ul style="list-style-type: none"> • Check the security of SeaTalk connectors between functioning and non-functioning units. • Check the condition of SeaTalk cable between functioning and non-functioning units.

SVIB

10.3 Power up troubleshooting

Problems at power up and their possible causes and solutions are described here.

Problem	Possible causes	Possible solutions
The system (or part of it) does not start up.	Power supply problem.	Check relevant fuses and breakers.
		Check that the power supply cable is sound and that all connections are tight and free from corrosion.
		Check that the power source is of the correct voltage and sufficient current.

SVIB

10.4 Miscellaneous troubleshooting

Miscellaneous problems and their possible causes and solutions are described here.

Problem	Possible causes	Possible solutions
Display behaves erratically: <ul style="list-style-type: none"> • Frequent unexpected resets. • System crashes or other erratic behavior. 	Intermittent problem with power to the display.	Check relevant fuses and breakers.
		Check that the power supply cable is sound and that all connections are tight and free from corrosion.
		Check that the power source is of the correct voltage and sufficient current.
	Software mismatch on system (upgrade required).	Go to www.raymarine.com and click on support for the latest software downloads.
	Corrupt data / other unknown issue.	Perform a factory reset. <div style="border: 1px solid black; padding: 5px; margin-top: 5px;"> <p>Important: This will result in the loss of any settings and data (such as waypoints) stored on the product. Save any important data to a memory card before resetting.</p> </div>

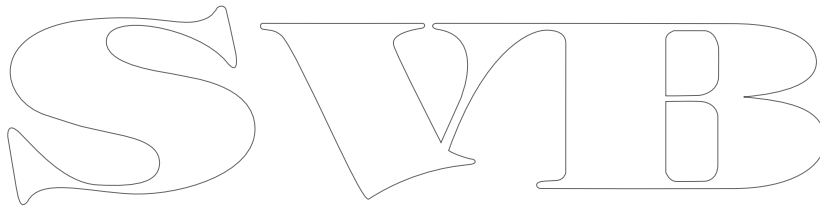

The image shows a large, stylized outline logo for 'SVMB'. The letters are interconnected and have a decorative, calligraphic feel. The 'S' is on the left, followed by 'V', 'M', and 'B' on the right. The logo is centered horizontally on the page.

10.5 Self-test

The unit has a built in self-test to aid fault diagnosis. The resulting failures and / or fault codes should be used when contacting Raymarine customer support.

Starting self-test

1. Press and hold the **Up** and **Action** buttons simultaneously for 4 seconds to access the self-test mode.
2. Within 2 seconds of entering self test mode press the **Up** and **Down** buttons simultaneously to begin self-test stage 1.

Self-test stages

The self-test comprises of 3 stages

Self-test stage 1

When entering self-test stage 1, the unit beeps and the display shows **TEST 1**, for 1 second.

Self-test stage 1 will perform the following tests:

- SeaTalk self-test, which checks the receive and transmit circuits.
- EEPROM test (read and write).

If the tests are satisfactory, **PASS** is shown on the display.

If the tests are not satisfactory, the following failure codes may be generated:

Fault code
FAIL 8
FAIL 18

To start self-test stage 2, press the **Up** and **Down** buttons simultaneously.

Self-test stage 2

When entering self-test stage 2, the unit beeps and the display shows **TEST 2**, for 1 second.

Self-test stage 2 will perform the following tests:

- Backlighting test, which cycles between on and off every second.
- Display test, which tests the LCD segments in the following sequence, changing once per second:

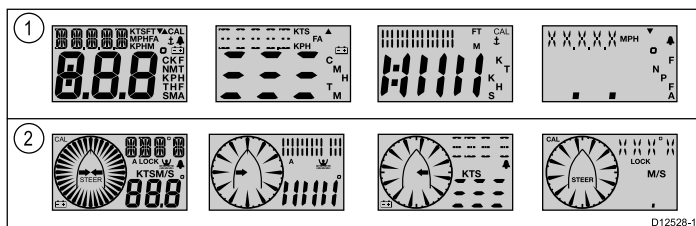

1	i40 Bidata, i40 Depth and i40 Speed
2	i40 Wind

While the test is progressing, press each of the display buttons and check that the buzzer sounds as each button is pressed.

The table below show possible problems that may be encountered:

Failure
No illumination
No beep when button pressed
LCD segment(s) missing completely
Faint LCD segment(s)

To start self-test stage 3, press the **Up** and **Down** buttons simultaneously.

Self-test stage 3

A known good transducer must be connected for self-test stage 3, and the vessel must be underway at sufficient speed for the tests to be performed.

When entering self-test stage 3, the unit beeps and the display shows **TEST 3**, for 1 second.

Self-test stage 3 will perform a transducer test

If the test is satisfactory then **PASS** is shown on the display.

If the test is not satisfactory then a fail code will be shown on the display:

Fault code	Transducer
FAIL 36	Wind
FAIL 43	Depth
FAIL 44	Speed

To exit self-test stage 3, press the **Up** and **Down** buttons simultaneously.

SWIB

Chapter 11: Technical support

Chapter contents

- [11.1 Raymarine customer support on page 60](#)

SWIB

11.1 Raymarine customer support

Raymarine provides a comprehensive customer support service. You can contact customer support through the Raymarine website, telephone and email. If you are unable to resolve a problem, please use any of these facilities to obtain additional help.

Web support

Please visit the customer support area of our website at:

www.raymarine.com

This contains Frequently Asked Questions, servicing information, e-mail access to the Raymarine Technical Support Department and details of worldwide Raymarine agents.

Telephone and email support

In the USA:

- **Tel:** +1 603 324 7900
- **Toll Free:** +1 800 539 5539
- **Email:** support@raymarine.com

In the UK, Europe, the Middle East, or Far East:

- **Tel:** +44 (0)13 2924 6777
- **Email:** ukproduct.support@raymarine.com

Product information

If you need to request service, please have the following information to hand:

- Product name.
- Product identity.
- Serial number.
- Software application version.

You can obtain this product information using the menus within your product.

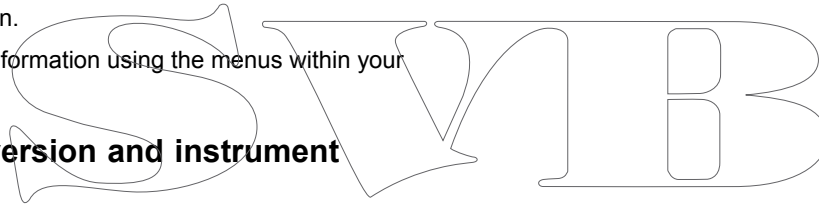

Checking software version and instrument status

During normal operation:

1. Simultaneously press and hold the **Down** and **Action** buttons for 4 seconds to display the software version.

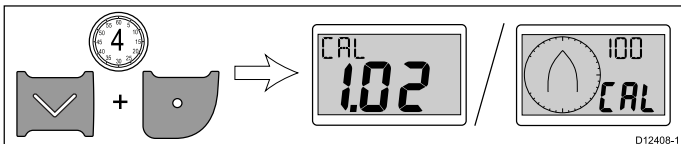

2. Press the **Action** button to display the instrument status.

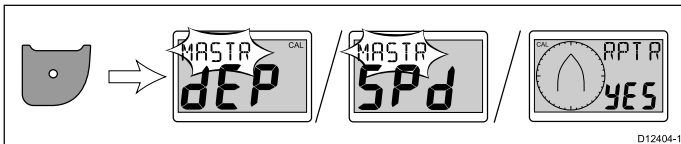

Note: The i40 Bidata requires an extra Action button push to switch from depth instrument status and speed instrument status.

3. Use the **Up** and **Down** buttons to change the instrument status between Master and Repeater.
4. To save your settings and return to normal operation from any page, simultaneously press and hold the **Down** and **Action** buttons for 2 seconds.

Chapter 12: Technical specification

Chapter contents

- [12.1 Technical specification on page 62](#)
- [12.2 Operating ranges on page 63](#)

SWIB

12.1 Technical specification

	i40 Bidata	i40 Depth	i40 Speed	i40 Wind
Nominal supply voltage	12 V dc	12 V dc	12 V dc	12 V dc
Operating voltage range	10 V dc to 16 V dc	10 V dc to 16 V dc	10 V dc to 16 V dc	10 V dc to 16 V dc
Current consumption (12V supply) typical	35 mA	30 mA	25 mA	25 mA
Current consumption (12V supply) maximum	100 mA	100 mA	100 mA	100 mA
Operating temperature	0°C to +70°C (32°F to 158°F)	0°C to +70°C (32°F to 158°F)	0°C to +70°C (32°F to 158°F)	0°C to +70°C (32°F to 158°F)
Storage temperature	-30°C to +70°C (-22°F to 158°F)	-30°C to +70°C (-22°F to 158°F)	-30°C to +70°C (-22°F to 158°F)	-30°C to +70°C (-22°F to 158°F)
Relative humidity	93%	93%	93%	93%
Water proofing	IPX6	IPX6	IPX6	IPX6
Connections	<ul style="list-style-type: none"> • SeaTalk • Speed transducer connections • Depth transducer connections 	<ul style="list-style-type: none"> • SeaTalk • Depth transducer connections 	<ul style="list-style-type: none"> • SeaTalk • Speed transducer connections 	<ul style="list-style-type: none"> • SeaTalk • Wind transducer connections
Conformance	Europe 2004/108/EC	Europe 2004/108/EC	Europe 2004/108/EC	Europe 2004/108/EC

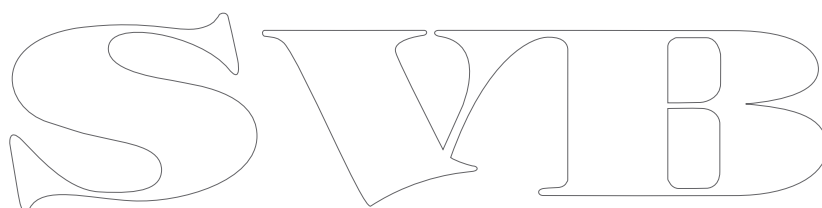

The image shows a large, stylized outline logo for 'SWIB'. The letters are interconnected and have a decorative, slightly irregular font style. The 'S' is on the left, followed by 'W', 'I', and 'B' on the right.

12.2 Operating ranges

i40 Bidata	i40 Depth	i40 Speed	i40 Wind
<ul style="list-style-type: none">• Speed: 0 to 99.9 knots• Log: 0 to 99999 nautical miles• Trip: 0 to 99 nautical miles• Temperature: -0°C to +40°C• Depth: 0 to 400 feet• Shallow depth alarm: 0 to 29 feet• Deep depth alarm: 30 to 400 feet• Shallow anchor alarm: 1 to 250 feet• Deep anchor alarm: 10 to 400 feet	<ul style="list-style-type: none">• Depth: 0 to 400 feet• Shallow depth alarm: 0 to 29 feet• Deep depth alarm: 30 to 400 feet• Shallow anchor alarm: 1 to 250 feet• Deep anchor alarm: 10 to 400 feet	<ul style="list-style-type: none">• Speed: 0 to 99.9 knots• Log: 0 to 99999 nautical miles• Trip: 0 to 99 nautical miles• Temperature: -0°C to +40°C	<ul style="list-style-type: none">• Wind speed: 0 to 60 knots• High wind speed alarm: 5 to 50 knots• Wind angle: 180° port to 180° starboard

SVIB

SWIB

Chapter 13: Spares and accessories

Chapter contents

- [13.1 Accessories on page 66](#)
- [13.2 i40 transducers on page 66](#)
- [13.3 Spares on page 67](#)
- [13.4 SeaTalk accessories on page 67](#)
- [13.5 SeaTalk power cables on page 68](#)
- [13.6 Converters on page 68](#)

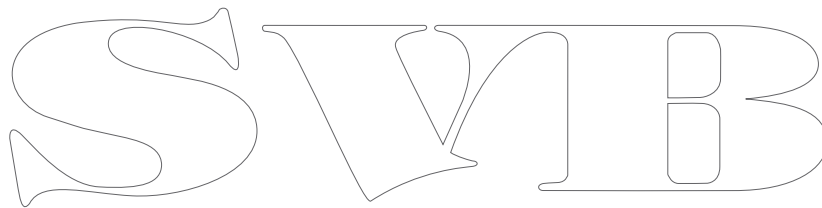

13.1 Accessories

Description	Part number	Notes
Desktop mounting bracket	E25024	
SeaTalk interconnect kit	E25028	

13.2 i40 transducers

The following transducers are available for the i40 range:

Description	Part number	Notes
Depth transducer	E26009	
Speed transducer	E26008	
Rotavecta	Z195	

Note: Other transducers are available please check with your local Raymarine dealer.

SVIB

13.3 Spares

The table below lists the spare parts available for i40 instrument displays

Description	Part number	Note
i40 front bezel	R70112	
i40 Sun cover	R70113	

13.4 SeaTalk accessories

SeaTalk cables and accessories for use with compatible products.

Description	Part No	Notes
3-way SeaTalk junction box	D244	
1 m (3.28 ft) SeaTalk extension cable	D284	
3 m (9.8 ft) SeaTalk extension cable	D285	
5 m (16.4 ft) SeaTalk extension cable	D286	
9 m (29.5 ft) SeaTalk extension cable	D287	
12 m (39.4 ft) SeaTalk extension cable	E25051	
20 m (65.6 ft) SeaTalk extension cable	D288	

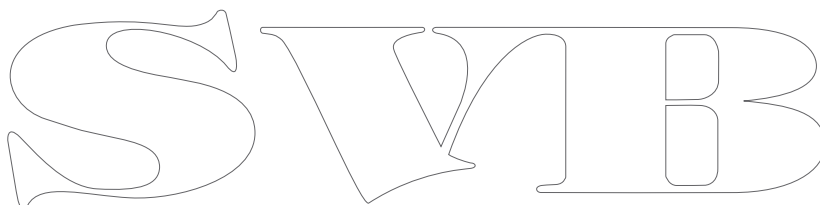
The image shows the letters 'SVIB' in a large, stylized, outlined font. The letters are interconnected and have a decorative, calligraphic feel. The 'S' is on the left, followed by 'V', 'I', and 'B' on the right.

13.5 SeaTalk power cables

Part number	Description
D229	SeaTalk power cable.

13.6 Converters

Part number	Description
E22158	SeaTalk to SeaTalk ^{ng} Converter

SVIB

SWIB

Raymarine®
A FLIR COMPANY
SVIB