

CH2800 / CH2850
marine engine controls for
side mounting

Teleflex
MARINE

Installer
These instructions contain important safety
information and must be forwarded to the boat owner.

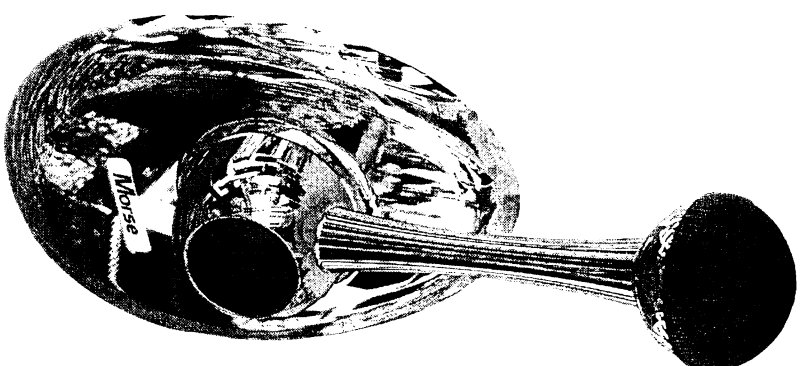

Teleflex Sidomonterade motorreglage
for vagnmotorer
CH2800 / CH2850

Preparations

NB! Before starting the installation please read the instruction carefully

When deciding on the best position for the control keep the control lever movements in mind. Ensure full throttle movement without obstruction at position chosen before the hole is cut.

Also check that space required for installation is sufficient. See fig. 9 and 10

Fig. 1 & 2

B mechanism

- A Alternative gear cable holders
- B Gear lever
- C Gear cable connection for ± 38 mm travel
- D Gear cable connection for ± 31 mm travel
- E Adjustable brake
- F Neutral position knob
- G Throttle cable holder
- H Throttle lever
- J Screw
- K Washer
- L Attachment holes for neutral safety switch

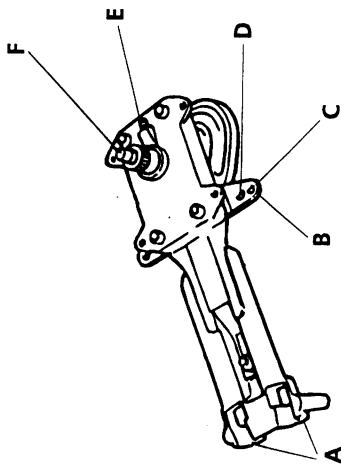

Fig. 1

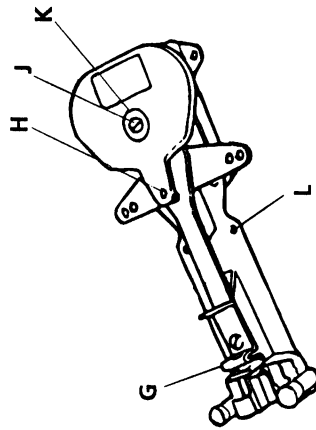

Fig. 2

Using the mechanism

Cable travel must be in accordance with the engine. Standard feature of the mechanism is pulling throttle function. This can be changed to pushing throttle function:

- Remove screw and washer (J&K fig. 2). Lift off the throttle lever (H fig. 2)
- Reposition screw and roller from A to B (fig. 3).
- Turn the throttle lever 180°, and refit. Note that at pushing throttle the roller (A fig. 4) must be in the inner groove (B fig. 4).

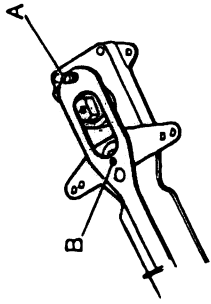

Fig. 3

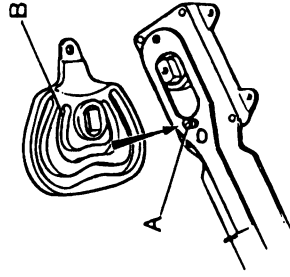

Fig. 4

The mechanism has a two-sided gear arm suitable for pulling as well as pushing gear function without prior modification. The gear cable should be connected to the side of the lever which gives the correct function. For standard travel i.e. ± 38 mm connect the gear cable to the outer holes (C fig. 1). The inner holes (D fig. 1) are intended for special applications requiring a travel of ± 31 mm.

Lever with switch (Ch2800)

Fig. 5 describes the functions of the switch and electrical connection.

The switch may be used for operating a bow truster or winch. Max switching amperage 5A.

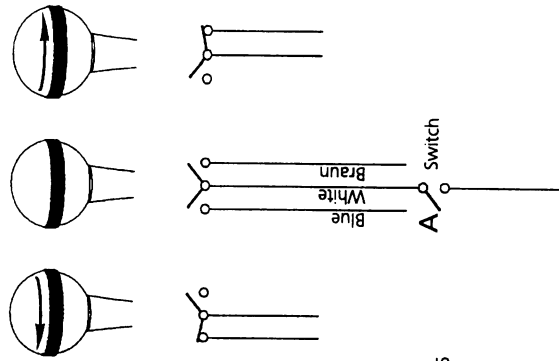

Fig. 5

WARNING! Always install a "main switch" A Fig. 5 (not included) to prevent unintentional use of the switch in the lever (CH2800).

Installing the control

Mark the cut out area using the templates (enclosed page). Make sure the control is placed in the correct position. Cut the hole and drill the holes for the attachment screws using a 4,0 mm drill.

Connecting the cables

Check that the lever movements are correct.

NB! Connect the cables to mechanism but do not attach them to the engine or gear until the complete control is installed.

Attaching the throttle cable

- Remove the nut (A fig. 6) and both rubber seals (B fig. 6) from the cable.
- Push the cable through the bracket (C fig. 6)
- Put rubber seals and nut back in place.
- Secure the cable with the locking pin (D fig. 6)

NB the locking pin must be fitted with the wavy side towards the mechanism.

- Thread the pivot (A fig 7) on to the rod until 4 mm of the rod protrudes (see fig. 7). Secure the pivot by tightening the nut (B fig. 7)
- Connect the pivot to the throttle lever (E fig 6) and secure with the split pin. (F fig. 6)

NOTE! To avoid the shift arm from unintentional locking do not engage the push button on the control lever until the mechanism is mounted and the control cables are connected. Should it yet happen, the shift arm can be turned back to neutral position by hand. It is not possible to restore the shift arm to neutral by using the control lever.

Attaching the gear cable

- Push the gear cable through the holder and make sure the cable jacket hooks securely to the holder (A fig. 8).
- Thread the pivot on to the rod until 4 mm of the rod protrudes (see fig. 7). Secure the pivot by tightening the nut. (B fig. 7)
- Connect the pivot to the gear lever (B fig. 8) and secure with the split pin. (C fig. 8)

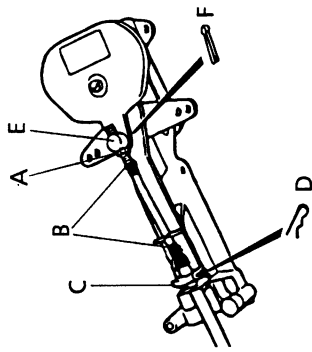

Fig. 6

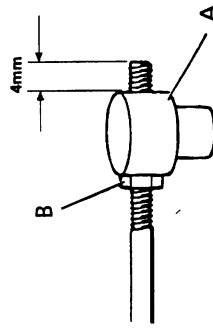

Fig. 7

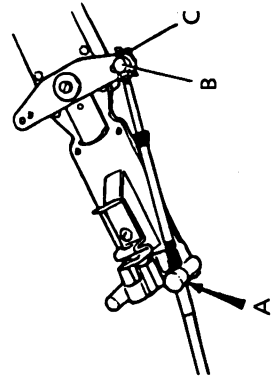

Fig. 8

Installation of cables

The minimum control cable bend radius is 200 mm. Sharper bends will increase cable wear rapidly.

Throttle cable

As the throttle cable moves back and forth during operation, it must not be clamped too close to the mechanism as this would prevent its motion. Subsequently this would lead to an overload of the mechanism with stiff shifting and premature wear as result. Hence, the throttle cable should be routed with one or two bends close to the mechanism for troublefree operation. Check that the throttle travel is free by pushing the shift release knob (F fig. 1 side 2) and moving the control lever. When correctly installed, the lever can be moved without noticeable resistance or a spongy feeling.

Shift cable

The shifting cable is secured to the mechanism and can therefore be clamped to a bulkhead adjacent to the mechanism.

- Guide the mechanism through the hole. Depending on whether the mechanism is fitted from outside or inside different techniques are used.

Mounting from inside:

- Shift the mechanism to neutral position with the lever.
- Remove the lever and pull out the mechanism through the hole. (Fig. 10)
- Secure the mechanism with the attachment screws.

Mounting from outside:

Fit the lever and shift to forward. Push in the mechanism using the lever, see fig. 11, and position the mechanism as in fig. 12. Shift back to neutral position and proceed as per fig. 13 & 14

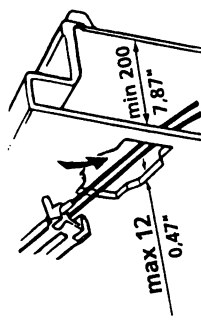

Fig. 9

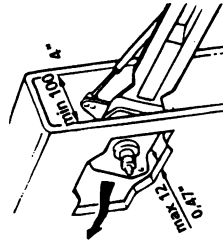

Fig. 10

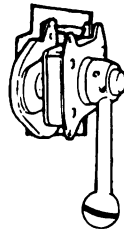

Fig. 11

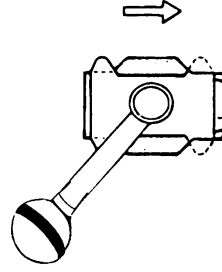

Fig. 12

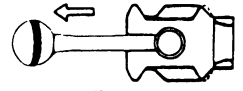

Fig. 13

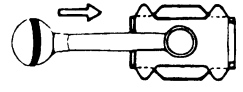

Fig. 14

Mounting of cover and lever

- Fit the cover. Make sure the tabs snap properly into the lugs (B fig. 15).

Lever with switch (CH2800)

⚠ IMPORTANT! As not to damage the electrical wire at lever movement, the wire has to be laid as fig. 16

- Grease the shaft splines (C fig. 15) springly and install the lever.
- Tighten the clamp screw (A fig. 17) and make sure the lever is securely attached to the shaft.

Don't tighten too hard, just attach the screw securely.

- Check the lever travel.
- Move the lever to engaged gear position. Push the neutral position button (B fig. 17) firmly in place.
- Connect the cables to the throttle and gear levers on the engine. Use connections recommended by the engine manufacturer.

Check that the cables move smoothly and that the throttle opens.

Adjusting the throttle brake

The mechanism has an adjustable brake to counteract unwanted lever movement (happens mostly with diesel engines). Turning the adjusting screw (A fig. 18) clockwise increases the friction.

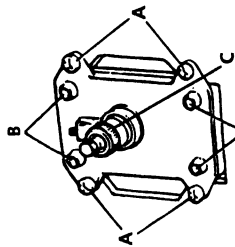

Fig. 15

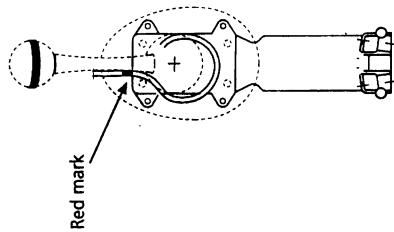

Fig. 16

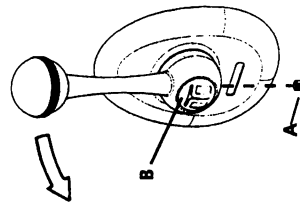

Fig. 17

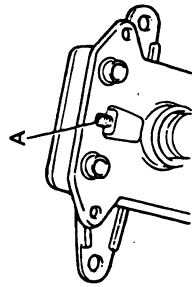

Fig. 18

⚠ IMPORTANT NOTICE! Applied force onto the handle must not exceed 200N when normally operated. Force feedback from the cables must not exceed 70 N to be able to maintain the set value. Forces exceeding those mentioned might cause failure to the mechanism and thereby cause the manoeuvrability to be limited.

Accessories

Neutral safety switch

- The engine control can be equipped with a neutral safety switch to prevent accidental starting with gear engaged.

NB The switch (A fig. 19) must be mounted with the electrical plugs (B fig. 19) turned away from the gear cable.

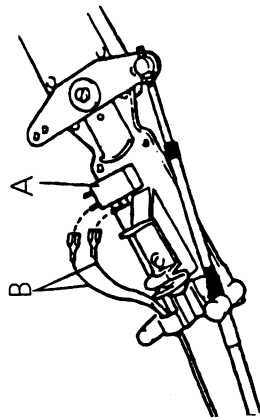

Fig. 19

Mall för sidmonterat reglage
Template for side mounted control

Endast / Only

CH2800

Ø 20

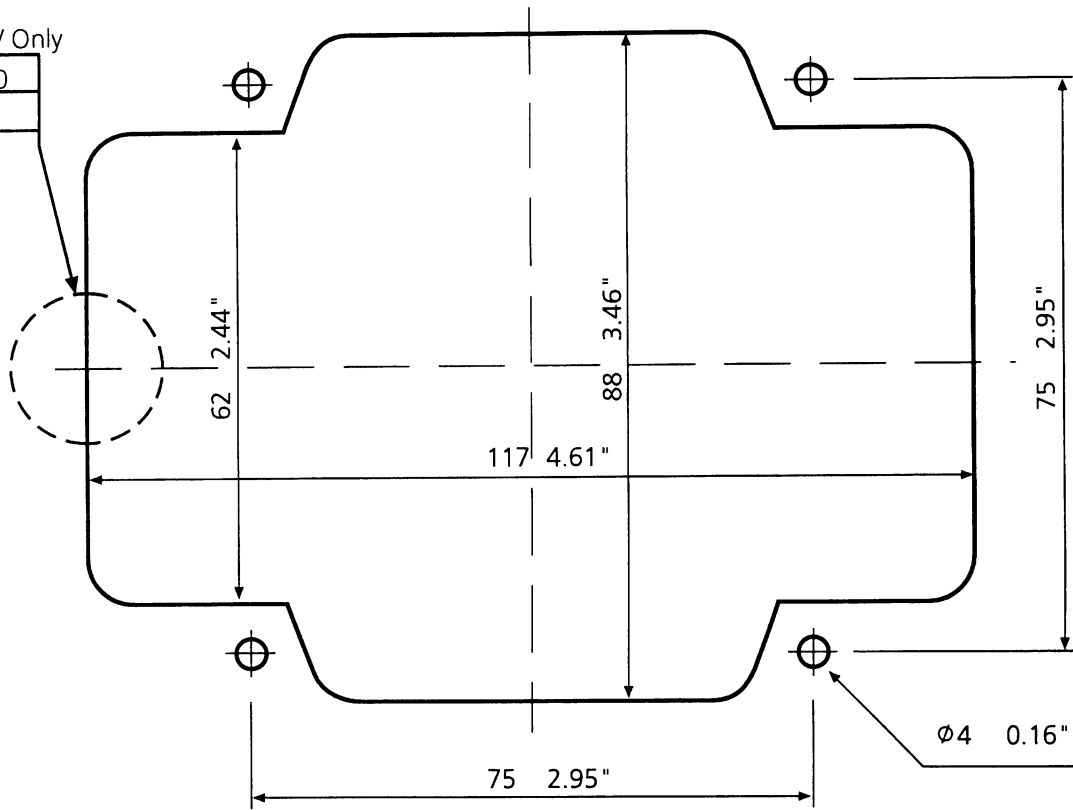

Gaunts Business Centre
Gaunts Common
Wimborne
Dorset
UK
BH21 4JT
Tel: +44 (0)1202 885212
Fax: +44 (0)1202 885214

Teleflex®
M A R I N E

Distributör

Falkenström Tryckeri AB 104ft

Distributör

Teleflex®
M A R I N E

Gaunts Business Centre
Gaunts Common
Wimborne
Dorset
UK
BH21 4JT
Tel: +44 (0)1202 885212
Fax: +44 (0)1202 885214