

MARLINCO®

**A Boater's
Guide To AC
Electrical
Systems**

Preface

This handbook is intended to provide you with a basic understanding of the AC electrical systems used by major boat builders in the United States, Canada and abroad. It will also familiarize you with many Marincos brand-name electrical products.

Before delving into this book, however, we recommend that you thoroughly read and understand the information provided in your boat's owners manual – and that you take the time to carefully inspect your on board systems. Know where the panelboard is located; identify the circuits controlled by each breaker and review how your shore power system operates.

AC electrical systems are fairly straightforward and understandable. Using common sense and knowledge of the basics, you can probably pinpoint and correct many problems yourself. But when things get too complicated, or if you feel major modifications are called for, nothing beats a qualified marine electrician. Not only do they know their business, but they probably use Marincos electrical products as well.

SVIB

Marinco

2655 Napa Valley Corporate Drive
Napa, California 94558
Phone: 707.226.9600 Fax: 707.226.9670
Visit our website at www.marinco.com

BOATER'S GUIDE TO ALTERNATING CURRENT (AC) ELECTRICAL SYSTEMS

TABLE OF CONTENTS

Understanding Your Boat's Electrical System	4-8
Hooking Up To Shore Power/Service At Marinas	8-9
Shore Power Inlets, Plugs and Cordsets	10-11
Shore Power Adapters & Marincos Product Features	12-15
Do-It-Yourself Installation Guide	16
Troubleshooting	16-17
Safety Guidelines	18
Wiring Diagrams	19-21
Glossary of Terms	22-23
FAQs (Frequently Asked Questions)	24

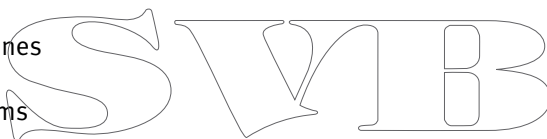



UNDERSTANDING YOUR BOAT'S ELECTRICAL SYSTEM

Getting to the Heart of the Matter

Your boat's AC electric system is a lot like your body's circulatory system. Your heart pumps blood throughout your body via a network of arteries. These arteries can be large or small, depending on the need of the organs or muscles they supply.

Your boat's electrical panelboard is the "heart" of the electrical system. Electric current created by a shore side power source or AC electrical generator is distributed throughout the boat by "hot" wires or ungrounded conductors. These vary in size based on the job they must perform.

When you turn on an AC light or appliance, current flows through the hot conductor to make the light glow or the appliance operate. Once the electricity has done its work, its potential or pressure drops to zero and it returns to its source through the neutral, or grounded, conductor.

Here are some key differences based on vessel type, size and power needs. Marincio, for example, offers the following categories:

- Basic small boat systems use a three-conductor, 15 ampere; 125 volt vinyl covered cord. A system like this usually supplies one device, usually a battery charger and has no branch circuits (Fig. 1). This system is used only on trailer boats on dry land.

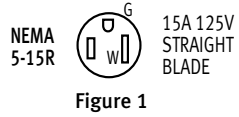

- Mid-size boats often use a 30 ampere, 125 volt electrical system (Fig. 2). The shore power cord and matching inlet are fitted with threaded rings providing a watertight connection from power source to boat. From the inlet, 30-ampere conductors lead to the boat's AC panelboard, from which power is distributed through branch circuits.

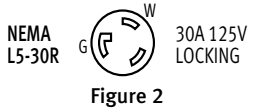

- Larger boats can use a 50 ampere, 125 volt system (Fig. 3). In both the 30 and 50-ampere systems, the shore power cord contains three conductors. Black is ungrounded ("hot") and carries 125 volts of electricity, white is grounded conductor or neutral and green is the grounding conductor.

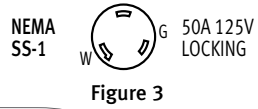

- Still larger yachts may use a 50 ampere or 100 ampere, 125/250 volt system (Fig. 4) This shore power cord contains four conductors – the white neutral conductor, the green grounding conductor, and red & black ungrounded conductors each carrying 125 volts. The two 125 volt conductors provide the 250 volts needed to power large appliances like ranges and clothes dryers.

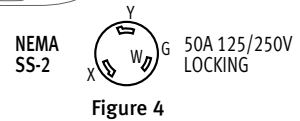

- Yachts designed for international service may be equipped with 16 or 32 amp/220V/50Hz systems. Be sure to check out your systems requirements before you set sail.

One Plug Doesn't Fit All

The above figures show that plugs/receptacles for each of these systems have different, non-interchangeable configurations. This is a safety feature designed to prevent a plug from one system from being used with a different system.

HOT TIP: Never modify or change a plug/receptacle to work with a different system...this can cause electrocution or damage equipment.

When it Comes to Electricity, Size Does Matter

It's vital to select an AC electrical system that's appropriate for the job it will be asked to perform. Remember this simple equation: volts X amperes = watts. A 15-ampere, 125-volt system has 1,875 available watts. By comparison, a 50 ampere, 250-volt system has 12,500 available watts. For reference, a common appliance such as a toaster oven uses about 1,500 watts.

HOT TIP: Overloading your boat's circuits can cause damage, overheating or fire hazards. Calculate your vessel's electrical needs and use an appropriate system.

Polarity – Go With The Flow

Your boat's electrical system is polarized. In other words, the wiring in your boat is connected in the same relation – white to neutral, green to ground, and the hot wires will be another color, either red or black throughout the vessel.

To help you check your shore power polarity, most boats with 3-wire shore power cords are equipped with a panelboard that has a polarity indicator built in. Check your boat's owner's manual to review what polarity protection you may have and to review the function of your boat's panelboard.

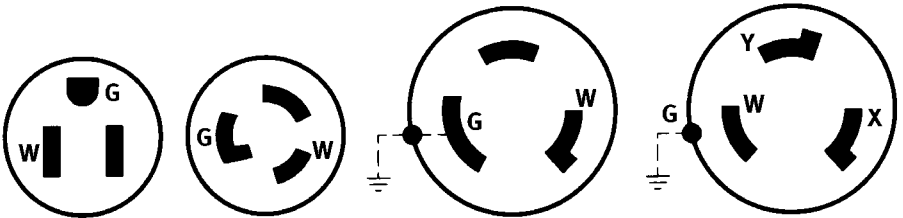

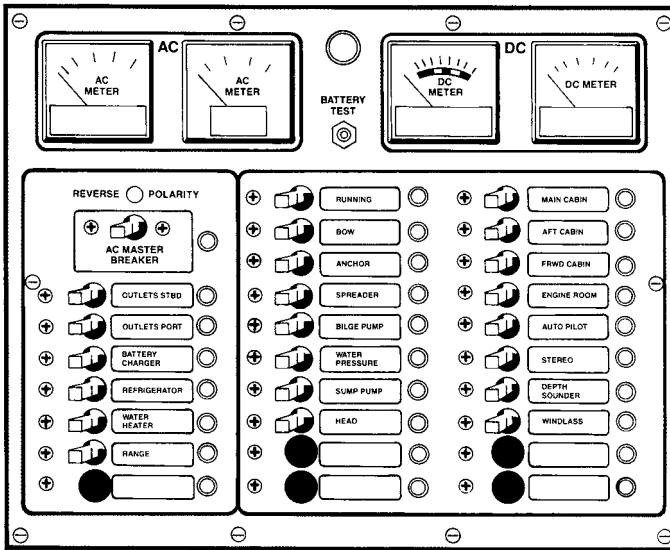

Know Your Boats Electrical Panelboard

In a properly designed system, electricity first enters your boat through a main circuit breaker at the AC panelboard. Within the panelboard, the electricity is transferred to any of several branch circuits, each with their own circuit breakers. Typical circuits and breakers are rated as follows:

outlets: 15 amps;
 refrigerator: 10 amps;
 water heater: 20 amps;
 stove: 20 amps; and
 battery charger: 5 amps.

Circuit breakers automatically interrupt the flow of electricity if the current exceeds the rating the circuit is designed to handle. An overloaded circuit generates heat and could cause a fire, so a properly wired and maintained panelboard is a critical piece of safety equipment.

Remember that a “tripped” circuit breaker means you’ve got a problem that needs to be fixed immediately. You might simply have an overloaded circuit, in which case you need to redistribute your appliances to other circuits. Or you could have an electrical breakdown with an appliance or other equipment that’s causing a problem. Figure out the problem and solve it before resetting the breaker!

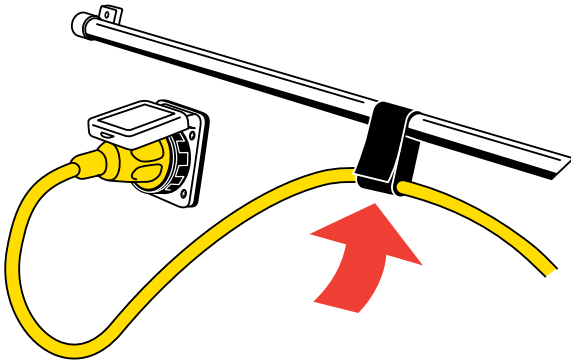

PRO TIP: Use items such as Marincos Cable Clips, ZipSleeve or Velcro straps to lead shore power cables away from the water, to prevent chaffing and pinch points around the dock and to keep cables clean.

Generator On Board

Auxiliary generators are becoming more common on many boats. If you've got a generator, the AC power it generates enters your boat's electrical system through the AC panelboard, just like "shore power." You've got a rotary switch at the panelboard that will allow you to select "shore power", "generator" or an "off" position that cuts off all incoming AC power altogether. This switch prevents you from having incoming electricity from more than one source.

HOT TIP: If you have more than one source of AC power, always isolate the two sources by a switch that breaks off from one source before making the connection to the second source (break before make switch).

Hooking Up to Shore Power

Remember these steps when hooking up your shore power cords:

1. Turn off the boat's shore connection switch before connecting or disconnecting shore cable.
2. Connect shore power cable at the boat FIRST.
3. If polarity warning indicator is activated, immediately disconnect the cable.
4. Disconnect shore power cable at the dockside FIRST.
5. Close shore power inlet cover tightly after disconnecting.

Electrical Service at Marinas

Perhaps the most frustrating moment for the new boat owner occurs when he arrives at a marina only to find that his boat's shore power cord will not plug into the dockside power source. Although the National Electric Code has established standards for marinas, many marinas in existence today were built prior to the adoption of the Code in 1978. For this reason, the knowledgeable yachtsman has several adapters aboard if he travels from one marina to another.

Newer marinas have locking type shore power receptacles that will allow your boat's 30 ampere or 50 ampere shore cord to be plugged in without an adapter. A smart yachtsman with a 30 ampere or lighter electrical system will carry an adapter with a 15-ampere, 125-volt straight blade plug with a locking screw.

Boats utilizing two 30 ampere electrical systems would be wise to carry two of the 15 ampere, 125 volt straight blade adapters as well as two "Y" adapters – one being a 50 ampere 125/250 volt straight blade crowfoot with grounding clip and the other being the 50 ampere 125/250 volt locking type.

It is good policy to try and ascertain the type of shore power connection available at your destination before you begin your voyage. It is not enough to rely upon the local cruising guide because they usually only tell you whether the power is 125 or 250 volt.

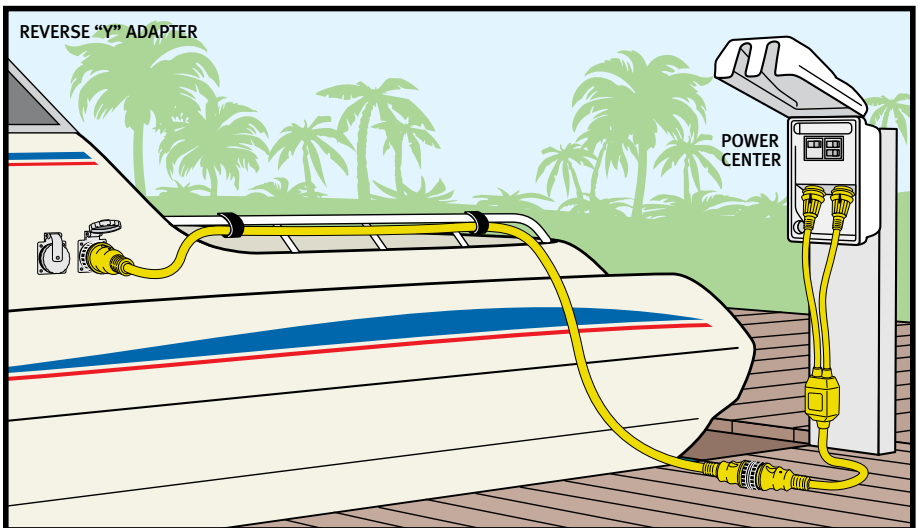

MARINCO®

DOCKSIDE

30A
125V
2 Pole
3-Wire
Locking

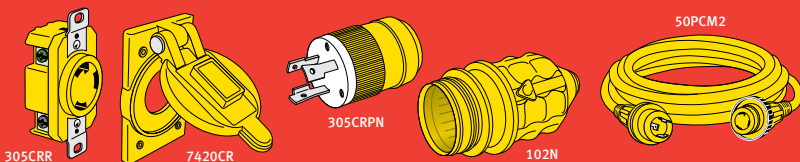

50A
125V
2 Pole
Locking

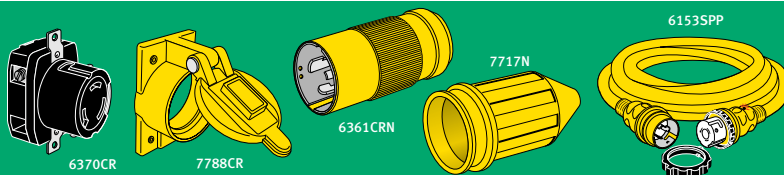

50A
125/250V
3 Pole
4-Wire
Locking

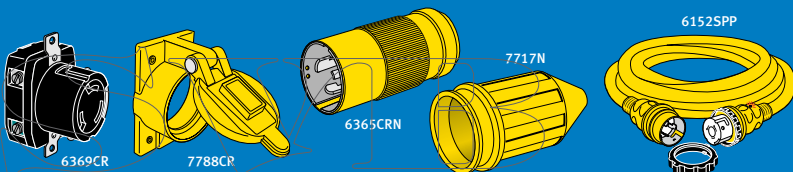

**PHONE
CABLE TV**

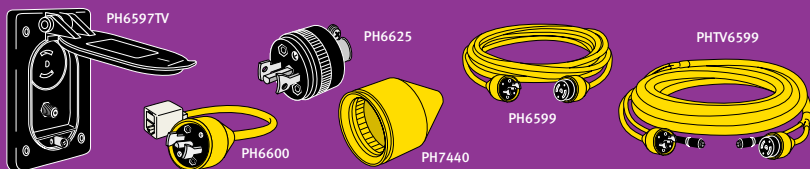

12V
SEALINK®

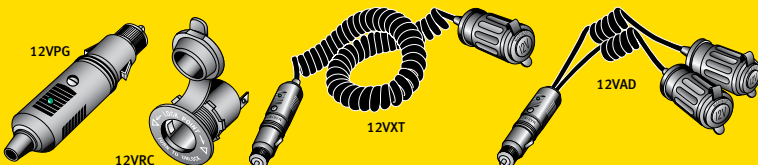

12V
ConnectPro®

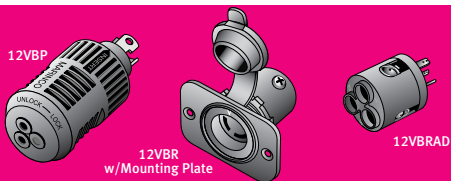

Reverse "Y" Adapter

The Reverse "Y" adapter (167RYN) has two male plugs with special power isolation circuitry for added safety. When one plug is connected to a receptacle, the circuitry isolates the second plug. The Reverse "Y" provides 50A 125/250V power when only 30A

SHORE POWER SYSTEMS

BOATSIDE

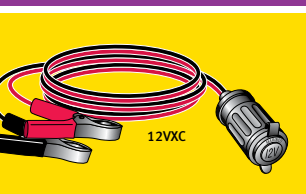
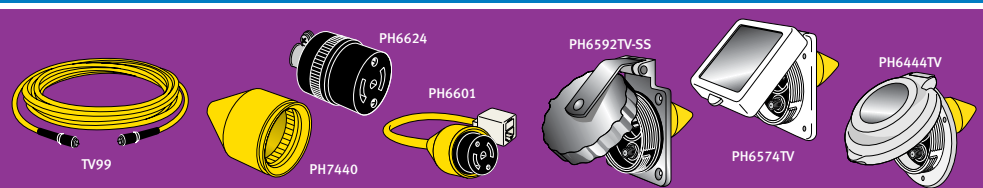
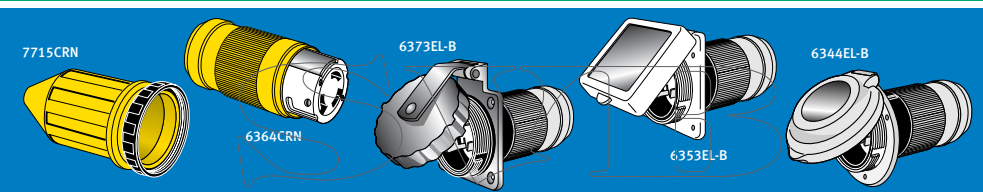
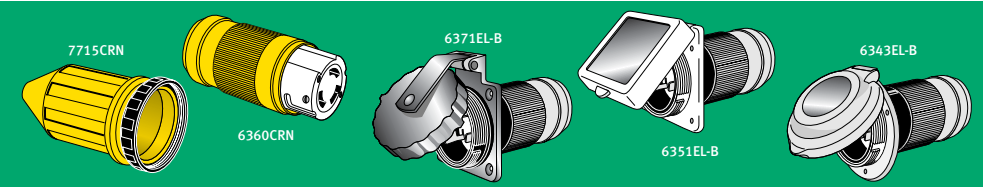
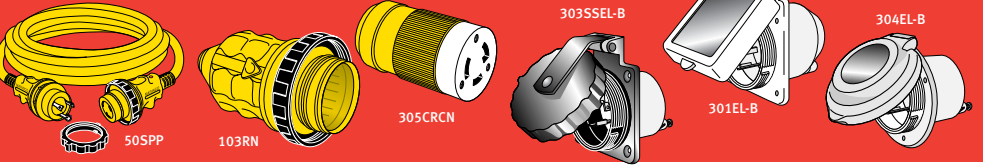

125V receptacles are available. (Note: will NOT work with 125V, 3-wire inlets.) Power is provided in both circuits to the 4-wire inlet, but the dockside receptacles limit the current in each circuit to 30 amps. The two 30A 125V receptacles must be supplied from a single power source providing from 208V to 250V between them for proper operation.

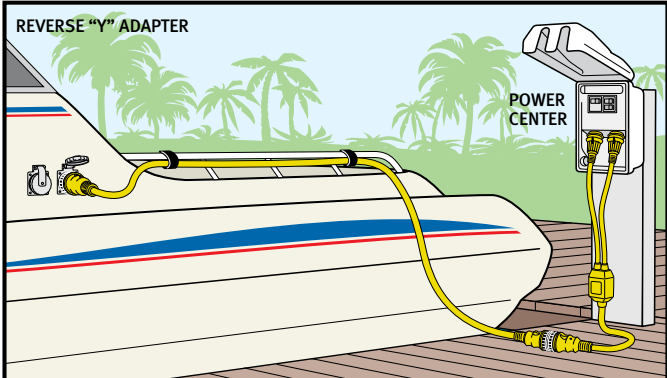

MARINCO Adapters

Reverse “Y” Adapter

A Reverse “Y” allows for a boat with 50 ampere 125/250 volt shore power inlet to draw power from two 30 ampere 125 volt receptacles on the dock.

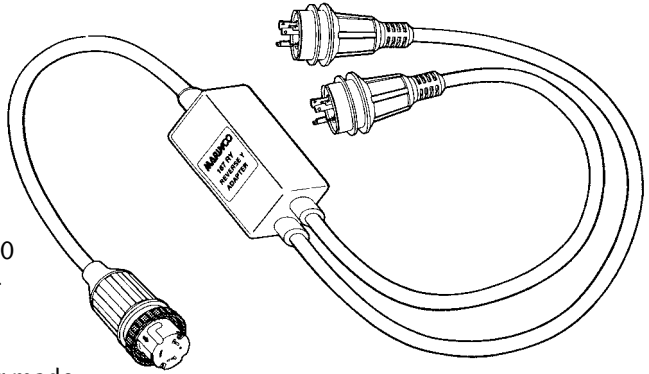

A Standard “Y” adapter made with two plugs and used to draw power from two receptacles expose the boater to two real hazards.

After one 30A plug is connected to dockside, electricity can energize the second plug. The exposed blades in the second plug are a shock hazard to anyone who should touch them.

If one of the 30A dock receptacles has reverse polarity (hot and neutral wired in reverse), the second plug becomes energized at 120V. Not only is there a severe shock hazard present, but plugging in the second plug short circuits the electrical system, creating a potential fire hazard.

The Reverse “Y” has circuitry which does not allow power to go through until both 30A plugs are inserted into receptacles and energized.

The Reverse “Y” will work only if there is more than 200 volts between both the 30A receptacles, and neither of the receptacles has reverse polarity.

MARINCO Adapters

Here are the important points to consider when using a Shore Power Adapter.

- Dielectric tests (integrity of insulation) and continuity tests (correct wiring) are both run on each adapter.
- Prior to shipment all products are visually inspected to make sure all wire is UL listed and oil and moisture resistant.
- The wire gauge is selected based on the device rating.

- To insure good connectivity, splices in the “Y” adapters are insulated (butt type) and applied with a crimping tool.
- The molded portions are produced in a yellow vinyl wire-jacketing compound.
- Note: When using any adapter remember: Outlet and equipment must be of the same voltage rating.
- Total amperage drawn should not exceed amperage rating of the lowest rated component of the adapter.
- Polarity and grounding must be maintained.

50A 125/250V	50A 125V	30A 125V	20A 125V	15A 125V
--------------	----------	----------	----------	----------

STRAIGHT ADAPTERS

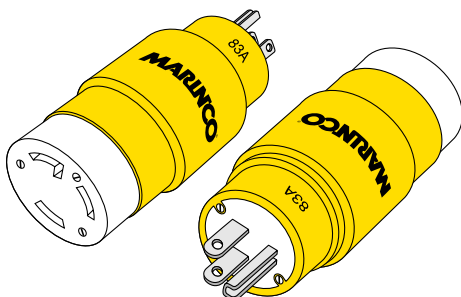
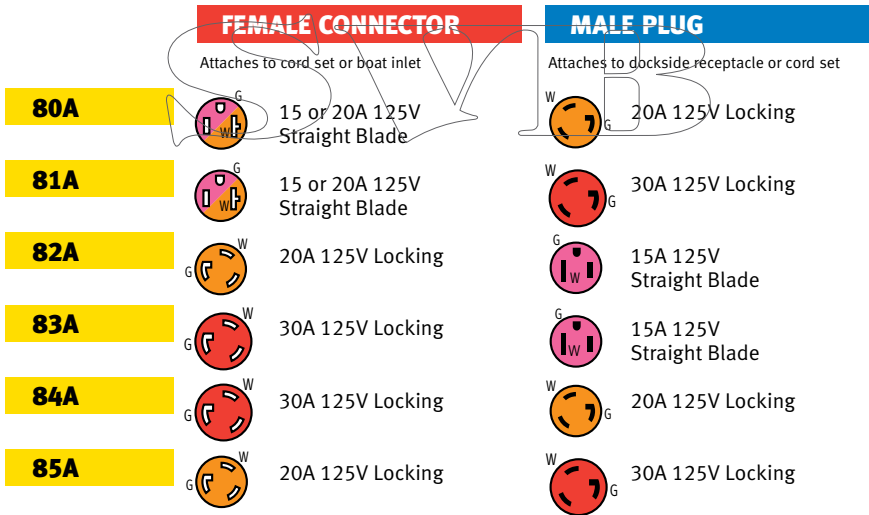















These adapters do not have covers and are not recommended for use in wet locations.

PIGTAIL ADAPTERS

FEMALE CONNECTOR

Attaches to cord set or boat inlet

- 104A**  30A 125V Locking with Sealing Collar System
also in white-104AW
- 105A**  15A 125V Straight Blade
- 106A**  30A 125V Locking with Sealing Collar System
- 107A**  15A 125V Straight Blade
- 108A**  20A 125V Locking with Sealing Collar System
- 110A**  30A 125V Locking with Sealing Collar System
- 111A**  50A 125V Locking with Sealing Collar System
- 112A**  50A 125V Locking with Sealing Collar System
- 114A**  50A 125/250V Locking Sealing Collar System
- 115A**  50A 125V Locking with Sealing Collar System
- 117A**  50A 125/250V Locking with Sealing Collar System
- 118A**  50A 125/250V Locking with Sealing Collar System
- 121A**  30A 125V Locking with Sealing Collar System
- 123A**  50A 125V Locking with Sealing Collar System

MALE PLUG

Attaches to dockside receptacle or cord set

-  15A 125V Straight Blade with locking screw
-  30A 125V Locking
-  20A 125V Locking
-  20A 125V Locking
-  50A 125V Locking
-  50A 125V Locking
-  30A 125V Locking
-  20A 125V Locking
-  50A 125/250V Straight Blade Crowfoot with Molded Grounding Clip
-  15A 125V Straight Blade with locking screw
-  30A 125V Locking
-  50A 125V Locking
-  50A 125/250V Locking
-  50A 125/250V Locking

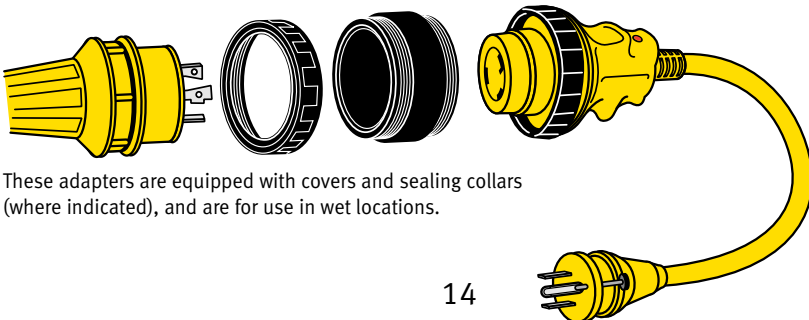

These adapters are equipped with covers and sealing collars (where indicated), and are for use in wet locations.

“Y” ADAPTERS

FEMALE CONNECTOR

Attaches to cord set or boat inlet

MALE PLUG

Attaches to dockside receptacle or cord set

150AY			2-15 or 20A 125V Straight Blade		30A 125V Locking
151AY			2-30A 125V Locking w/ Sealing Collar Systems		50A 125/250V Straight Blade Crowfoot with Molded Grounding Clip
152AY			2-30A 125V Locking w/ Sealing Collar Systems		50A 125V Locking
153AY			2-30A 125V Locking w/ Sealing Collar Systems		50A 125/250V Locking
154AY			2-50A 125V Locking w/ Sealing Collar Systems		50A 125/250V Locking
157AY			2-30A 125V Locking w/ Sealing Collar Systems		30A 125V Locking
162AY			2-50A 125V Locking w/ Sealing Collar Systems		50A 125V Locking
164AY			2-50A 125V Locking w/ Sealing Collar Systems		50A 125/250V Straight Blade Crowfoot with Molded Grounding Clip
165AY			2-50A 125/250V Locking w/ Sealing Collar Systems		50A 125/250V Locking
166AY			2-50A 125V Locking w/ Sealing Collar Systems		30A 125V Locking
167RYN			50A 125/250V Locking w/ Sealing Collar Systems		2-30A 125V Locking

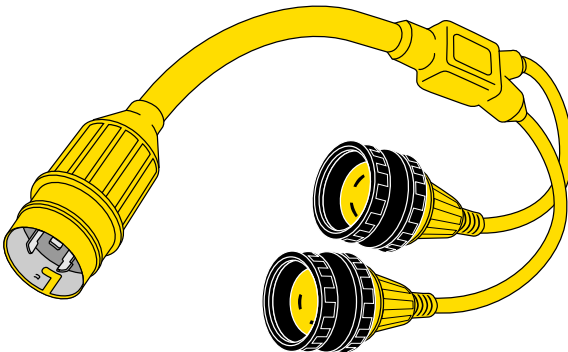

These adapters are equipped with covers and sealing collars (where indicated), and are for use in wet locations.

You Can Do It Yourself

Working with your boat's electrical system is something you may choose to leave to a professional. After all, a proper job is vital to your vessel's safe operation. On the other hand, with the right tools and the right marine electrical equipment, wiring on your boat is a relatively easy job.

Helpful Hints for Onboard Wiring

1. Always use UL listed boat cable, which has stranded wires. Household cable has single solid core wires that can break because of vibration.
2. Make sure wire strands are clean and not corroded. If necessary, cut back the wire until it is clean copper or replace it.
3. When installing receptacles or switches, allow an extra length of wire to remain in the box. Should the device have to be repaired or replaced, the extra length allows the device to be easily pulled from its box.
4. After wiring a switch or receptacle and before installing in a box, wrap electrical tape around the device, covering the terminal screws. This eliminates the chance of an arc and the possibility of a stray grounding conductor contacting the terminals.
5. When it comes to wire gauge do not use undersized wire. "When in doubt, use the next heavier gauge." Lighter wire is not only risky, but it makes appliances sluggish. The following are recommended ampacities for insulated conductors.

Gauge AWG	Ampacity
14	15
12	20
10	30
8	40
6	55

TROUBLE SHOOTING

MARINCO plugs, connectors, receptacles and inlets are engineered to provide years of trouble free service. However, the marine environment can cause problems with even the best designed devices. If problems can be detected while they are small, it can save the boat owner time and expense later on. The most common problems with electrical connections are salt water immersion and

overheating. Fortunately, overheating can be easily detected and quickly remedied. The following are precautions and solutions to extend the life of your MARINCO equipment.

What to look for...

Examine the ends of the shore power cords. Look for discoloration or melting around the blades of the plug (male end) and around the slots on the connector (female end). Examine the face of the inlet on the boat and look for discoloration or melting around the blades and the inlet. Examine the receptacle on the dock and look for discoloration or deterioration around the slots.

What causes overheating...

If a device shows signs of overheating, it is generally caused by one or two conditions: corrosion on the metal blades or contacts, or bad connections between the wiring device and the wires connected to it. Severely corroded blades or contacts are a result of exposure to a corrosive environment, most commonly salt water. If the ends of the cord set are dropped into salt water and not properly cleaned and dried, the contacts will eventually corrode. Corroded contacts do not make a good electrical connection and overheating results. Bad connections between a wiring device and the electrical wires can be a result of loose termination, corrosion on the wires or terminals, or the wires not being stripped properly so the wire insulation is under the terminals. A bad connection will result in overheating of the terminal, and this will be visible on the face of the wiring device.

What to do...

If a wiring device shows signs of overheating, it should be replaced immediately. Do not wait for the problem to get worse. When replacing wiring devices, examine the electrical wire and make sure the wire strands are clean, and are not corroded. Even a new device cannot make a good connection to corroded wire. Many boat owners think overheating is a result of over loading the circuit, but this is rarely the case. A bad connection in an inlet will also cause the mating connector to overheat. All too frequently a boat owner will merely continue to replace his connector, not realizing the inlet is causing the problem. Both devices should be replaced in order to prevent the problem from happening again. The same is true for the plug and the receptacle on the dock.

Carefully follow the wiring instructions supplied with all replacement devices to insure proper operation.

Salt Water Immersion...

Should any of your MARINCO wiring devices become immersed in salt water, shut off power to the unit immediately. Rinse devices thoroughly with fresh water and allow to dry. Shore power cords should hang several days to allow for complete drying. When dry, spray device with an electrical contact cleaner. This will displace any remaining water.

SAFETY GUIDELINES

It's important to follow some basic safety guidelines when working with AC marine electrical equipment and wiring.

1. Be sure that the boat's shore power cord is disconnected and that the auxiliary generator is turned off.
2. Test the wires in the circuit with a voltage tester to make sure the power is turned off. The voltage tester should indicate that no voltage is present.
3. Be sure the area you are working in is dry and free of moisture.
4. Keep all electrical wiring as high as practical above bilge water accumulation levels and a safe distance from exhaust systems, fuel systems and fresh water systems.
5. When completed, check your work with the Shore Power Cord set connected and the power turned on. Check from the hot wire to both the ground wire and the neutral wire with a volt meter to insure the proper voltage is present and the polarity is correct in the circuit. Check from the neutral wire to the ground wire making sure that voltage is not present.

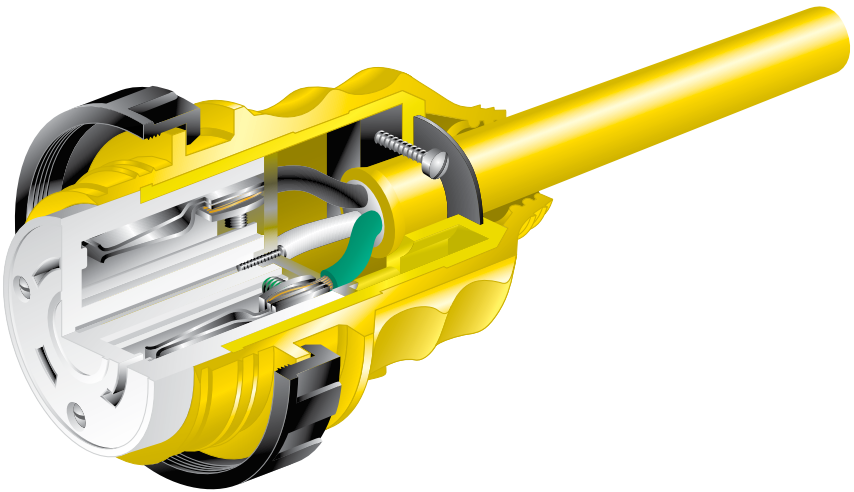

HOT TIP: Be sure to use weatherproof covers to help keep out moisture ... corrosion is the primary cause of failure in electrical equipment.

Diagram 1. Single-Phase 120 Volt System with Shore-Grounded Neutral Conductor and Grounding Conductor.

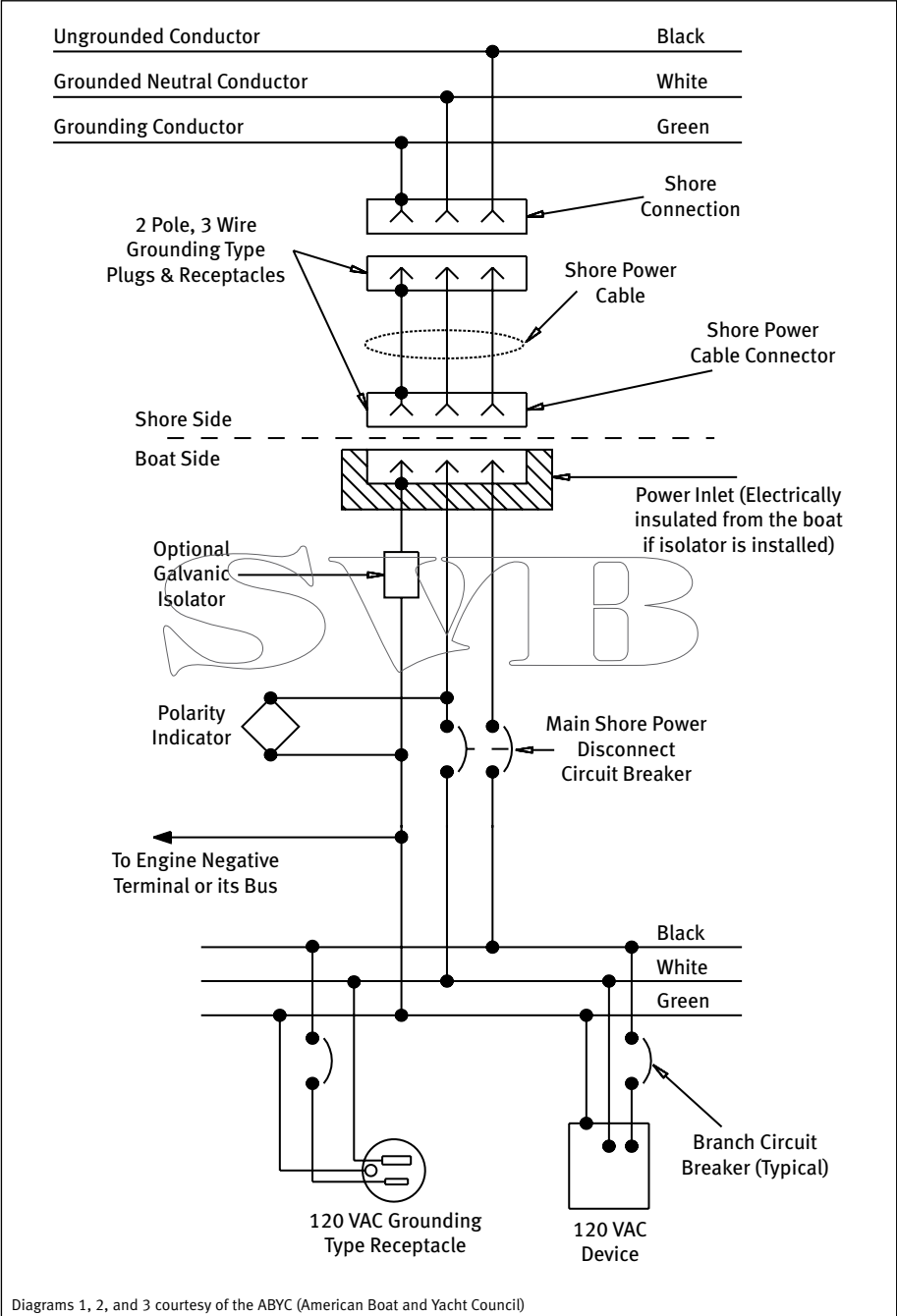

Diagrams 1, 2, and 3 courtesy of the ABYC (American Boat and Yacht Council)

Diagram 2. Single-Phase 120/240 Volt System with Shore-Grounded Neutral Conductor and Grounding Conductor.

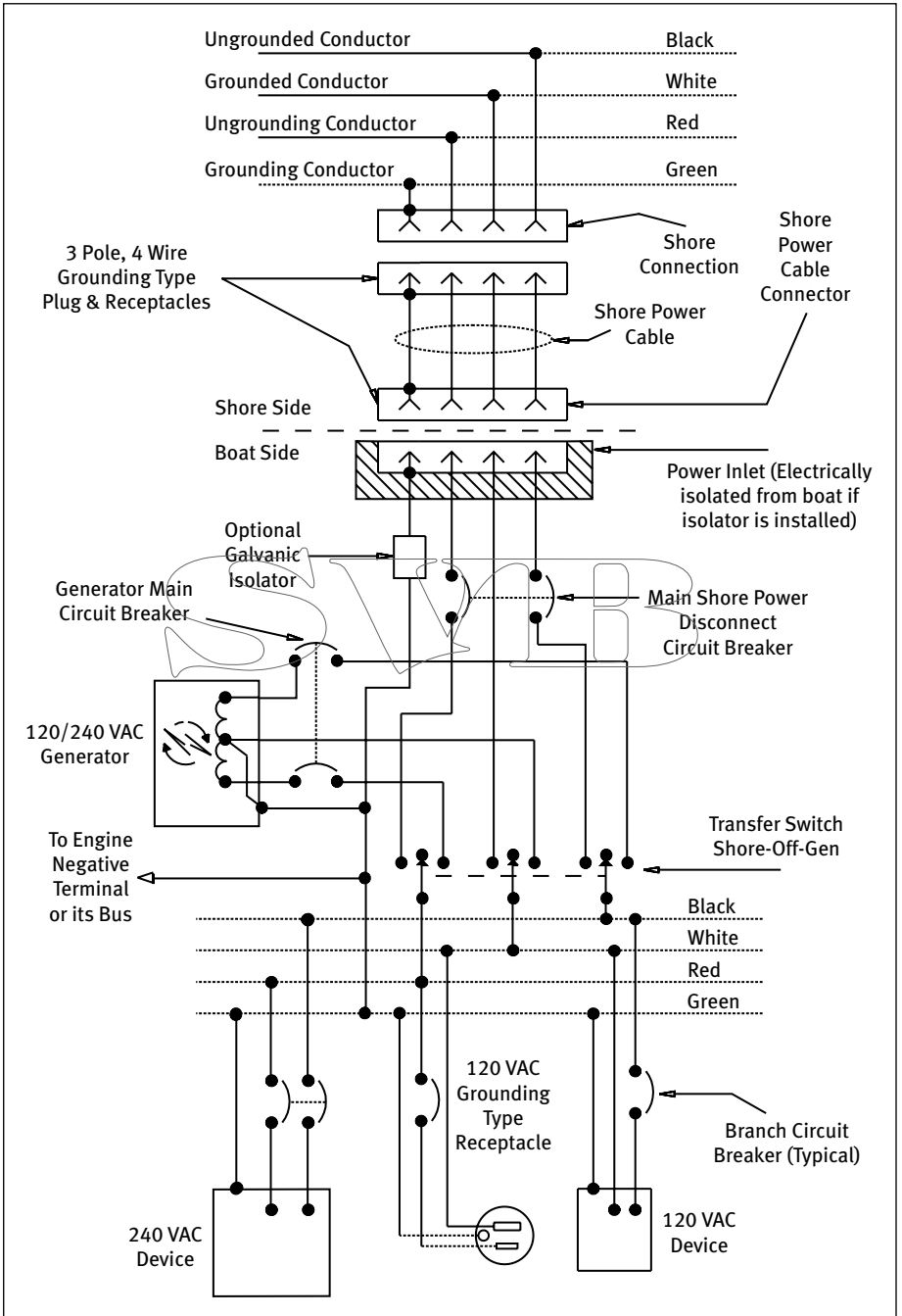
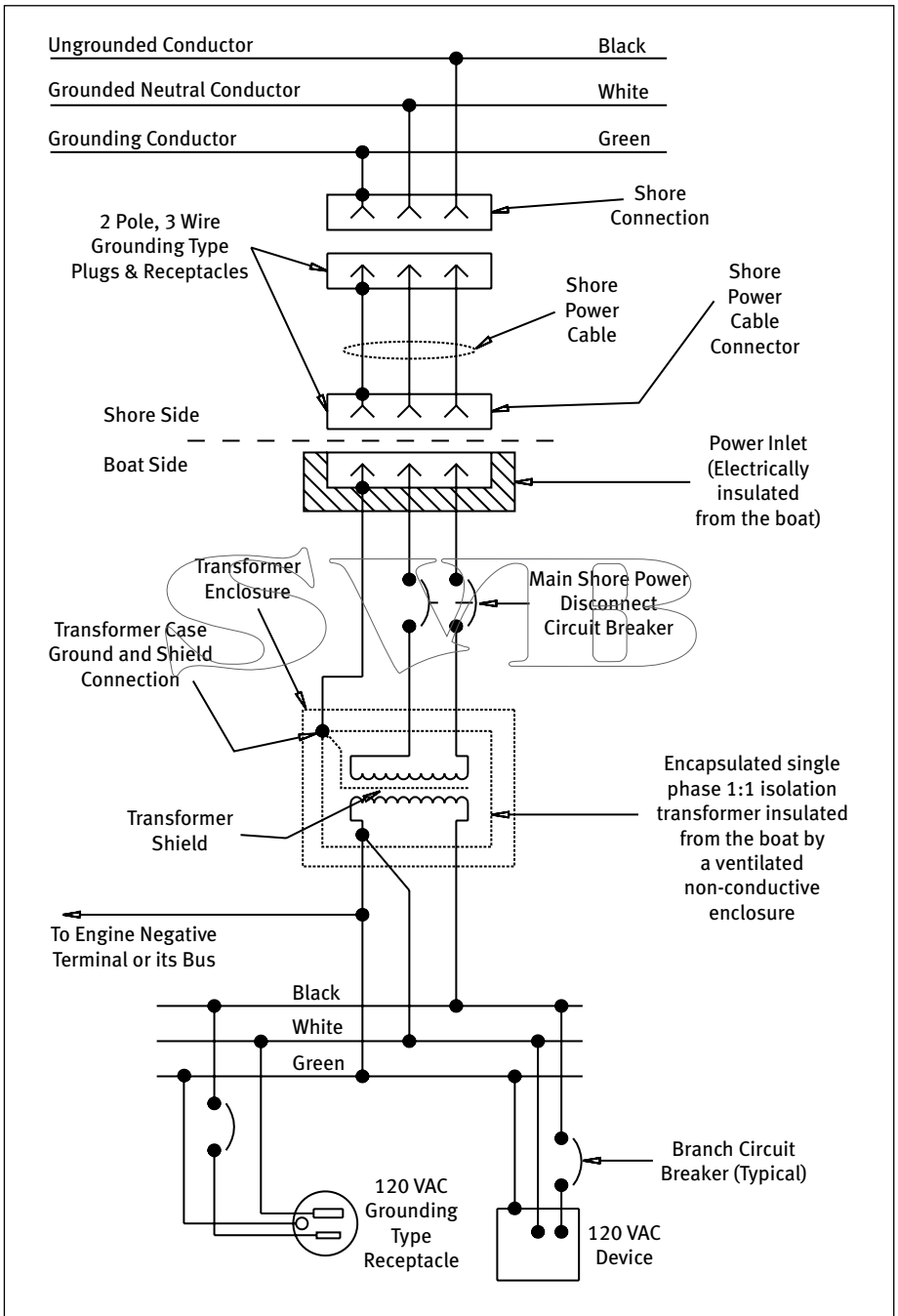

Diagram 3. Single-Phase 120 Volt Isolation Transformer System with Grounded Secondary.



A GLOSSARY OF ELECTRICAL TERMS

Understanding the following common electrical terms will help you better understand marine AC systems. Many of these terms are used in this book.

Ampere or Amp – The standard unit used to measure the strength of an electrical current. Commonly called “amps.”

Circuit Breaker – A device designed to interrupt the circuit when the current flow exceeds a predetermined value. It protects the circuits of your boat and allows you to turn off the power in a circuit so you can work without danger of shock.

Ground – Applies to the potential of the earth’s surface, which is zero.

Grounded Conductor – A current carrying conductor connected to the side of the source which is intentionally maintained at ground potential. In AC electrical systems this is also known as the neutral conductor and is white in color.

Ground Fault – This occurs when current is permitted to flow from a hot wire to ground. Causes can include worn insulation, moisture and deterioration in tools or appliances.

Ground-Fault Circuit-Interrupter – A device intended to protect people from electrocution by interrupting the electrical circuit to the load when a ground fault current exceeds a predetermined value (usually 5 milliamps) that is less than that required to trip the supply circuit breaker.

Grounding Conductor – A non-current carrying conductor provided to connect exposed metallic enclosures of electrical equipment to ground to minimize hazards of shock. In AC systems this is also known as the ground wire and is green in color.

CAUTION:
Ground Fault Circuit Interrupter protection is required when using electrical products outdoors or near water.

Isolation Transformer – A power transformer that has no connection between the primary and secondary conductors. The input and output are only magnetically coupled to each other.

Kilowatt – A unit of electrical power equal to 1,000 watts. Often used as a measure of AC electrical output for marine generators.

Line Fitting – A female connector (outlet or receptacle) providing a source for electrical current.

Load Fitting – A male plug containing the conductors for the power circuit and the grounding conductor for an electrical device.

Panelboard – A single panel or group of panel units assembled in the form of a single panel; including fuses, circuit breakers, with or without switches for the control of light, heat or power circuits. Usually placed in a cabinet or cutout box accessible only from the front.

Polarized System – A system in which the grounded (white) and ungrounded conductors are connected in the same relation to all terminals or fixture leads on all devices in the circuit.

Ungrounded Conductor – A current carrying conductor that is completely insulated from ground and connects the power source to equipment. Connected to the “hot” side of shore power systems or the appropriate terminal of an onboard generator. This is red or black in color.

Volt – Unit that measures the potential difference in electrical force, or pressure, between two points on a circuit. The current at most receptacles and lights is 125 volts*. As the current moves from the hot supply wire through the load presented by an appliance or light, it loses all voltage and enters the return circuit and provided by the grounded conductor at zero pressure.

Watt – The unit of power indicating the rate at which a device converts electrical current to heat or motion. Also the rate at which a device consumes energy. The formula for figuring approximate watts available is: amps X volts = watts.

* The 125 volt figure is a nominal value. A 125-volt system is often called a 120- or 110-volt system. Also, a 250-volt system is often called a 240-volt or 220-volt system. All are correct.

MARINCO – FAQS (FREQUENTLY ASKED QUESTIONS)

Where can I obtain marine electrical products?

Contact your local Marine Dealer or Distributor, or check our Dealer Locator on our website, www.marinco.com, to find your nearest Marinco supplier.

How do you clean shore power cords?

If your basic soap and water doesn't do the job, there are cord cleaners such as the Star brite™ brand available through most marine retailers. Acetone works best for those really stubborn scuff marks.

What is the difference between 50 amp 125 volt and 50 amp 125/250 volt?

The blade configurations are different. In other words, one system may not be used with the other. 50 amp 125 volt is a 3 wire system (1 hot wire, 1 neutral, 1 ground). 50 amp 125/250 volt is a 4 wire system (2 hot wires, 1 neutral, 1 ground). Note: Each device has 3 blades. The 4 wire devices are grounded on the side.

Warning: never alter a plug to make it mate with another. If two devices do not fit together, there is an important reason.

I think I need an adapter to go from 30 amp to 50 amp....can you help me?

Please refer to our adapter chart on pages 13 – 15. More information is available on our website, www.marinco.com.

What if my shore power device was immersed in saltwater?

The device should be rinsed with fresh water, and allowed to dry. Then, it should be sprayed with a moisture displacement product/light lubricant.

Where can I get detailed installation instructions for inlets and other electrical connections?

Detailed instructions and online help are available at www.marinco.com. Online instructions can be easily downloaded and printed at home or office.



2655 Napa Valley Corporate Drive
Napa, California 94558
Phone: 707.226.9600 Fax: 707.226.9670
Visit our website at www.marinco.com