

High Precision Battery Monitor

## BattMan Pro

EN

Owner's manual

Thank you for purchasing a Mastervolt Battery Monitor.

Please read this owner's manual for information about using the product correctly and safely. Keep this owner's manual close to the battery monitor for future reference.

### Mastervolt International BV

Snijdersbergweg 93, 1105 AN Amsterdam,  
The Netherlands  
www.mastervolt.com

Before proceeding with this owner's manual, please make sure you have carefully read the enclosed installation and quick start guide as well!

## 1. BattMan Pro display and control overview

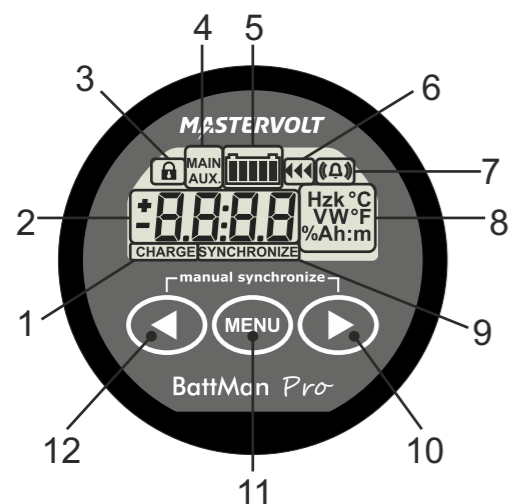

1. Charge battery indicator
2. Numeric value indicator field
3. Setup lock / Master lock indicator
4. Main battery or Auxiliary battery indicator
5. State-of-charge bar
6. Charging in progress indicator
7. Alarm activated indicator
8. Readout units
9. Synchronize indicator
10. Next value or Right key (>)
11. Menu key
12. Previous value or Left key (<)

## 2. Synchronisation

In order to keep your battery monitor delivering accurate status information about your battery, it is important to regularly synchronize your battery monitor with your battery. As explained in the quick start guide, a synchronisation step is also needed before you can actually use your battery monitor. During operation, the battery monitor automatically indicates when a synchronisation is required, by displaying the message SYNCHRONIZE.

A synchronisation step means nothing more than performing a complete charge cycle on your battery. A charge cycle will be considered complete when all discharged energy is restored in the battery and Auto-sync parameters F1.0, F1.1 and F1.2 (see chapter 5) are met. This typically means : when the battery charger switches to float mode. By meeting these conditions, the battery is considered full, which will be indicated by a flashing FULL message on the display. Besides this, the State-of-charge readout will be set to 100% and the Amphour readout reset to 0Ah. The FULL message will disappear when a key is pressed, or automatically, when the battery starts discharging again.

Performing synchronisations regularly is also important to keep your battery healthy and to increase it's lifetime. You will notice that if you are often performing full charge cycles yourselves, the battery monitor will most likely not display the SYNCHRONIZE message, since the battery is already kept in good sync with the battery monitor.

Besides automatic synchronisations based on meeting the Auto-Sync Functions, you can also manually synchronize the battery monitor with your battery when you are sure your battery is fully charged. This can be accomplished by pressing both < and > keys simultaneously for three seconds. After these three seconds, the flashing FULL message appears on the the display just like when it is automatically synchronized.

## 3. Status menu

The Status menu is a read only menu that shows the battery monitor's current status of several items. This menu can be accessed by the following sequence :

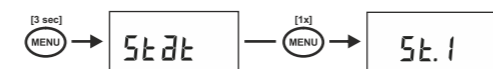

When the Status menu is entered, you can use the < and > keys to browse through the different status items. By pressing the MENU key, the selected status item can be viewed. Pressing the MENU key again, will then step back to the Status menu. From any menu position, the Normal Operating Mode can be accessed again by pressing the MENU key for 3 seconds. The following Status menu items are available :

St.1	Alarm Status. When multiple alarms are activated, use the < or > keys to browse through the currently active alarms. When no alarms are activated, this item displays "----".
St.2	Days running. The number of days the battery monitor is operating to monitor your battery. This item resets when a battery reset is executed (see Reset menu).
St.3	Days since last synchronized. The number of days the battery monitor has not been synchronized. This item resets when the battery monitor is synchronized or when a battery reset is executed (see Reset menu).
St.4	Charge Efficiency Factor (CEF). The charge efficiency factor used by the battery monitor. Depending on the value set in Function F5.6, this item displays the automatically calculated CEF or the manually set CEF.

## 4. History menu

The History menu is a read only menu that shows the battery monitor's History data. History data are special events that are stored in internal memory. This menu can be accessed by the following sequence :

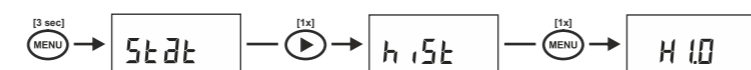

When the History menu is entered, you can use the < and > keys to browse through the different History items. By pressing the MENU key, the selected History item can be viewed. Pressing the MENU key again, will then step back to the History menu. From any menu position, the Normal Operating Mode can be accessed again by pressing the MENU key for 3 seconds. The following History menu items are available :

### H1 : BATTERY HISTORY :

H1.0	Average discharge in Ah. This number will be recalculated after each synchronization.
H1.1	Average discharge in %. This number will be recalculated after each synchronization.
H1.2	Deepest discharge in Ah.
H1.3	Deepest discharge in %.
H1.4	Total Amphours removed. The total number of Amphours removed from the battery. When exceeding 10000Ah, the units are kAh and the value displayed must be multiplied by 1000.
H1.5	Total Amphours charged. The total number of Amphours charged to the battery. These Amphours are not compensated by the Charge Efficiency Factor (CEF). When exceeding 10000Ah, the units are kAh and the value displayed must be multiplied by 1000.

H1.6	Number of cycles.
H1.7	Number of synchronizations. This is the number of times the battery is fully charged meeting the Auto-sync Functions.
H1.8	Number of full discharges. The number of times the battery has been fully discharged reaching a State-of-charge of 0.0%.

### H2 : ALARM HISTORY

H2.0	Number of Low Battery alarms.
H2.1	Number of Main battery low voltage alarms.
H2.2	Number of Auxiliary battery low voltage alarms.
H2.3	Number of Main battery high voltage alarms.
H2.4	Number of Auxiliary battery high voltage alarms.

## 5. Function setup menu

In the Function setup menu, your battery monitor can be adjusted to fit into your system. Lots of parameters, called Functions, can be set according to your needs. This menu can be accessed by the following sequence :

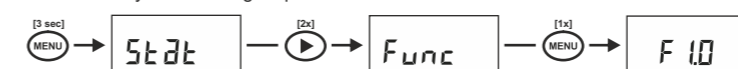

When the Function setup menu is entered, you can use the < and > keys to browse through the different Functions. By pressing the MENU key, the selected Function value can be viewed. The < and > keys can now be used to change this value. Pressing the MENU key again, will then step back to the Function menu. From any menu position, the Normal Operating Mode can be accessed again by pressing the MENU key for 3 seconds. This will also save any Function value changes to internal memory. When no keys are pressed for 90 seconds while operating in the Function setup menu, the battery monitor will automatically return to the Normal Operating Mode again without saving any Function value changes. The following Functions are available :

### F1 : SYSTEM PROPERTIES

F1.0	Charger's float voltage (Auto-sync parameter). This value must be equal to your battery charger's float voltage, which is the last stage of the charging process. In this stage the battery is considered full.	Default : 13.2V	Range : 8.0V - 33.0V	Step size : 0.1V
F1.1	Charger's float current (Auto-sync parameter). When the charge current is below this percentage of the battery capacity (see Function F5.0), the battery will be considered as fully charged. Make sure this Function value is always greater than the minimum current at which the charger maintains the battery or stops charging.	Default : 2.0%	Range : 0.5 - 10.0%	Step size : 0.1%
F1.2	Auto-sync time (Auto-sync parameter). This is the time the Auto-sync parameters F1.0 and F1.1 must be met in order to consider the battery as fully charged.	Default : 240sec	Range : 5 - 300sec	Step size : variable
F1.3	Discharge floor. This is the reference point at which the battery needs to be recharged. When the State-of-charge percentage falls below this value the Charge battery indicator starts flashing while the time remaining readout shows 0:00 and the State-of-charge bar is empty.	Default : 50%	Range : 0 - 99%	Step size : 1%
F1.4	Battery temperature. In this Function the average battery temperature can be adjusted.	Default : +20°C	Range : -20..+50°C	Step size : 1°C
F1.5	Time remaining averaging filter. Specifies the time window of the moving averaging filter. There are three settings, where setting 0 gives the fastest Time remaining readout response and setting 2 the slowest. The best setting will depend on the type of battery load and your personal preference.	Default : 1	Range : 0 - 2	Step size : 1
F1.6	Auto-sync sensitivity. Only change this setting when F1.0, F1.1 and F1.2 are set correctly and automatic synchronization still fails. If automatic synchronization takes too long or does never occur, lower this value. When the battery monitor synchronizes too early, increase this value.	Default : 5	Range : 0 - 10	Step size : 1

### F2 : LOW BATTERY ALARM SETTINGS

F2.0	Low battery alarm On (% SOC). When the <u>State-of-charge</u> percentage has fallen below this value, the alarm relay will be activated (depending on F2.6).	Default : 50%	Range : 0 - 99%	Step size : 1%
------	--	---------------	-----------------	----------------

F2.1	Low battery alarm On (Volts). When the <u>battery voltage</u> has fallen below this value, the alarm relay will be activated (depending on F2.6).	Default : 10.5V	Range : 8.0 - 33.0V	Step size : 0.1V
F2.2	Low battery alarm Off (% SOC). When the State-of-charge percentage has risen above this value and the alarm relay was activated, the alarm relay will deactivate again. When "FULL" is selected, the alarm relay is deactivated when the Auto-sync parameters are met.	Default : 80%	Range : 1 - 100% / FULL	Step size : 1%
F2.3	Low battery alarm On delay time. This is the time the Low battery alarm On conditions, F2.0 and F2.1, must be met before the alarm is activated.	Default : 10sec	Range : 0 - 300sec	Step size : variable
F2.4	Minimum 'Alarm On' time. Minimum time that the alarm relay stays activated even if the State-of-charge percentage has risen above the Low battery alarm Off setpoint (F2.2). Function units are hours:minutes.	Default : 0:00	Range : 0:00 - 12:00	Step size : variable
F2.5	Maximum 'Alarm On' time. Maximum time that the alarm stays activated even if the the State-of-charge percentage is still below the Low battery alarm Off setpoint (F2.2). The value ":-:" indicates an unlimited time, and the relay will stay activated until the State-of-charge percentage has risen above the Low battery alarm Off setpoint (F2.2). Function units are hours:minutes	Default : :-: -	Range : 0:00 - 12:00 / :-: -	Step size : variable
F2.6	Enable Low battery alarm / Use contact. Select "OFF" to disable the low battery alarm. Select "[1]" to use the battery monitor's internal alarm relay.	Default : [1]	Range : OFF / [1]	

### F3 : LOW VOLTAGE ALARM SETTINGS

F3.0	Main battery low voltage alarm On. When the Main battery voltage falls below this value, the message "Lo" will appear on the display and the selected alarm relay will be activated (depending on F3.2).	Default : 10.5V	Range : 8.0 - 33.0V	Step size : 0.1V
F3.1	Main battery low voltage alarm Delay. This is the time the Main battery low voltage alarm On condition, F3.0, must be met before the alarm is activated.	Default : 10sec	Range : 0 - 300sec	Step size : variable
F3.2	Enable Main battery low voltage alarm / Use contact. Select "OFF" to disable the Main battery low voltage alarm. Select "[1]" to use the battery monitor's internal alarm relay.	Default : OFF	Range : OFF / [1]	
F3.3	Auxiliary battery low voltage alarm On. When the Auxiliary battery voltage falls below this value, the message "Lo" will appear on the display and the selected alarm relay will be activated (depending on F3.5).	Default : 10.5V	Range : 8.0 - 33.0V	Step size : 0.1V
F3.4	Auxiliary battery low voltage alarm Delay. This is the time the Auxiliary battery low voltage alarm On condition, F3.3, must be met before the alarm is activated.	Default : 10sec	Range : 0 - 300sec	Step size : variable
F3.5	Enable Auxiliary battery low voltage alarm / Use contact. Select "OFF" to disable the Auxiliary battery low voltage alarm. Select "[1]" to use the battery monitor's internal alarm relay.	Default : OFF	Range : OFF / [1]	

### F4 : HIGH VOLTAGE ALARM SETTINGS

F4.0	Main battery high voltage alarm On. When the Main battery voltage rises above this value, the message "Hi" will appear on the display and the selected alarm relay will be activated (depending on F4.2).	Default : 16.0V	Range : 10.0 - 35.0V	Step size : 0.1V
F4.1	Main battery high voltage alarm Delay. This is the time the Main battery high voltage alarm On condition, F4.0, must be met before the alarm is activated.	Default : 5sec	Range : 0 - 300sec	Step size : variable
F4.2	Enable Main battery high voltage alarm / Use contact. Select "OFF" to disable the Main battery high voltage alarm. Select "[1]" to use the battery monitor's internal alarm relay.	Default : OFF	Range : OFF / [1]	

F4.3	Auxiliary battery high voltage alarm On. When the Auxiliary battery voltage rises above this value, the message "Hi" will appear on the display and the selected alarm relay will be activated (depending on F4.5).
Default : 16.0V	Range : 10.0 - 35.0V Step size : 0.1V
F4.4	Auxiliary battery high voltage alarm Delay. This is the time the Auxiliary battery high voltage alarm On condition, F4.3, must be met before the alarm is activated.
Default : 5sec	Range : 0 - 300sec Step size : variable
F4.5	Enable Auxiliary battery high voltage alarm / Use contact. Select "OFF" to disable the Auxiliary battery high voltage alarm. Select "[1]" to use the battery monitor's internal alarm relay.
Default : OFF	Range : OFF / [1]

## F5 : 'MAIN' BATTERY PROPERTIES

F5.0	Battery capacity. Your Main battery's capacity in Amphours (Ah).
Default : 200Ah	Range : 20 - 9990Ah Step size : variable
F5.1	Nominal discharge rate (C-rating). The discharge rate (in hours) at which the battery manufacturer rates your battery's capacity.
Default : 20h	Range : 1 - 20h Step size : 1h
F5.2	Nominal temperature. The temperature at which the battery manufacturer rates your battery's capacity.
Default : 20°C	Range : 0 - 40°C Step size : 1°C
F5.3	Temperature coefficient. This is the percentage that your battery's capacity changes with temperature. The unit of this value is percent capacity per degree Celsius. The setting "OFF" disables temperature compensation.
Default : 0.50%cap/°C	Range : OFF / 0.01 - 1.00 Step size : 0.01%cap/°C
F5.4	Peukert's exponent. The Peukert's exponent represents the effect of reducing battery capacity at higher discharge rates. When the Peukert value of your battery is unknown, it is recommended to keep this value at 1.25. A value of 1.00 disables the Peukert compensation and could be used for Lithium based batteries.
Default : 1.25	Range : 1.00 - 1.50 Step size : 0.01
F5.5	Self-discharge rate. This is the rate at which the battery loses capacity by itself, even when it is not used. The unit of this value is percent capacity per month at the Nominal temperature (F5.2). The setting "OFF" disables self-discharge compensation and could be used for Lithium based batteries.
Default : 3.0%/month	Range : OFF / 0.1 - 25.0%/month Step size : 0.1%/month
F5.6	Charge Efficiency Factor (CEF). CEF is the ratio between the energy removed from a battery during discharge and the energy used during charging to restore the original capacity. It is recommended to keep this value at "AU" (automatic calculation). The setting "100" disables charge efficiency compensation.
Default : AU	Range : 50 - 100% / AU Step size : 1%

## F6 : BATTERY MONITOR PROPERTIES

F6.0	Firmware version. Displays the firmware version of the battery monitor (read only).
Default : x.xx	

F6.1	Shunt Amp Rating. This Function is linked to F6.2 and represents the Amp rating of your shunt at the given voltage indicated by F6.2. Included with your battery monitor is a 500Amp/50mV shunt, meaning that at 500A flowing through the shunt, a voltage of 50mV is generated across the small 'Kelvin' screw terminals of the shunt. This voltage will be used by the battery monitor to measure the amount of current.
Default : 500A	Range : 10 - 9000A Step size : variable

F6.2	Shunt milliVolt Rating. This Function represents the milliVolt rating of your shunt at the given current indicated by F6.1. The battery monitor supports 50mV and 60mV shunts.
Default : 50mV	Range : 50 / 60mV

F6.3	Backlight mode. Represents the duration of backlight activation in seconds after key-press. The backlight can also be set to be always "ON" or always "OFF". Function setting "AU", activates the backlight automatically when charge / discharge current exceeds 1Amp or when a key is pressed.
Default : 30sec	Range : OFF / 5...300 / ON / AU Step size : variable

F6.4	Alarm contact polarity. Enables selection between a normally open (NO) or normally closed (NC) contact.
Default : NO	Range : NO / NC

F6.5	Voltage prescaler. This Function is only important when an optional voltage prescaler is installed on the battery monitor. All voltage related Functions are linked to this Function F6.5. Always keep this Function set to "1-1" when no prescaler is installed!
Default : 1-1	Range : 1-1 / 1-5 / 1-10

F6.6	Temperature unit selection. Enables selection between degrees Celsius (°C) and degrees Fahrenheit (°F) in the temperature readout.
Default : °C	Range : °C / °F

F6.7	Auxiliary input mode. This Function is used to configure the VA input terminal on the rear side of the battery monitor, and can be set in two modes. In mode "0", the VA input operates in normal voltage measurement mode. In mode "1", the VA input can be used to control the backlight. In this mode, the backlight is switched ON at an input voltage higher than 2V and switched OFF again if the voltage is below 1V.
Default : 0	Range : 0 / 1

F6.8	Communication mode. This Function is used to configure the data output mode. Intended for servicing purposes only.
Default : 0	Range : 0 / 1 / 2 / 3

F6.9	Setup lock. When set to "ON", all functions (except this one) are locked and cannot be altered. The Reset menu is also locked.
Default : OFF	Range : OFF / ON

## 6. Reset menu

In the Reset menu, you can reset a number of items of your battery monitor. This menu can be accessed by the following sequence :

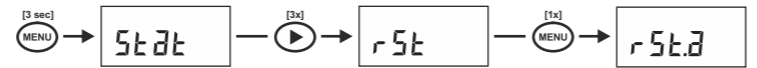

When the Reset menu is entered, you can use the < and > keys to browse through the different reset items. By pressing the MENU key, the selected reset item can be viewed. The default value for all reset items is "OFF". To actually reset the selected item, use the < and > keys to change the value from "OFF" to "ON". Pressing the MENU key again, will step back to the Reset menu. All reset items set to "ON" will only be reset once the Normal Operating Mode is accessed again by pressing the MENU key for 3 seconds. The following Reset menu items are available :

rSt.a	Reset alarms. Use this reset item to reset or ignore all current alarms.
rSt.b	Reset Battery status. Use this reset item to reset your current battery status (CEF, State-of-charge and battery history). You can use this reset item after you have installed a fresh battery of the same specifications as the previous one.
rSt.F	Reset Functions. This reset item can be used to reset all Function values to factory default values.
rSt.c	Reset zero-offset current. Use this reset item to remove small current readings on the display when no current is flowing in- or out of the battery. When performing this reset action, please be 100% sure that all DC consumers/chargers are disconnected or turned off.

## 7. Troubleshooting guideline

Problem	Remedy or suggestion
The monitor doesn't operate (no display)	- Check monitor- and battery side connections. - Make sure the inline fuses are installed and not blown. - Check battery voltage. Battery might be flat. Vbatt must be >8VDC. - Try to restart the monitor by removing / placing the fuses again.
Current readout gives wrong polarity (positive current instead of negative when discharging)	- Current sense leads from the shunt are reversed. Check the installation guide.
The monitor resets all the time	- Check the wiring for corrosion and / or loose contacts. - Battery might be flat or defective.
No changes can be made in the Function setup	- Check if the setup-lock is OFF (Function F6.9)
"CHARGE" or "SYNCHRONIZE" keeps on flashing	- Charge battery full (synchronize your battery with the monitor) - Check the Auto-sync parameters in Functions F1.0, F1.1 and F1.2 for possible wrong settings.

State-of-charge and/or time-to-go readout not accurate	- Check if all current is flowing through the shunt (the negative terminal of the battery may only contain the wire going to the battery-side of the shunt!). - Current sense leads from the shunt are reversed. - Check all Battery properties Functions (F5) - Check if battery monitor is synchronized. - Battery is exhausted and needs replacement
Display returns '- - -' in temperature readout	- Set battery monitor temperature to ambient temperature of the battery. See F 1.4
Battery voltage readout is highly inaccurate	- Check prescaler setting in Function F6.5

## 8. Warranty conditions

Mastervolt warrants this product to be free from defects in workmanship or materials for 24 months from the date of purchase. During this period Mastervolt will repair the defective product free of charge. Mastervolt is not responsible for any costs of the transport of this product.

This warranty is void if the product has suffered any physical damage or alteration, either internally or externally, and does not cover damage arising from improper use<sup>1)</sup> or from use in an unsuitable environment.

This warranty will not apply where the product has been misused, neglected, improperly installed or repaired by anyone other than Mastervolt. Mastervolt is not responsible for any loss, damage or costs arising from improper use, use in an unsuitable environment or improper installing, setup and malfunctioning of the product.

Since Mastervolt cannot control the use and installation (according to local regulations) of their products, the customer is always responsible for the actual use of these products. Mastervolt products are not designed for use as critical components in life support devices or systems, that can potentially harm humans and/or the environment. The customer is always responsible when implementing Mastervolt products in these kind of applications. Mastervolt does not accept any responsibility for any violation of patents or other rights of third parties, resulting from the use of the Mastervolt product. Mastervolt keeps the right to change product specifications without previous notice.

<sup>1)</sup> Examples of improper use are :

- too high input voltage applied
- wrong shunt connection
- applying battery voltage to shunt input
- mechanically stressed enclosure or internals due to harsh handling and/or incorrect packaging
- contact with any liquids or oxidation caused by condensation

## 9. Technical specifications

Parameter	BattMan Pro
Supply voltage range	9..35VDC
Supply current <sup>1)</sup> :	7mA
@Vin=24VDC	
@Vin=12VDC	9mA
Input voltage range (auxiliary battery)	2..35VDC
Input voltage range (main battery)	0..35VDC
Input current range <sup>2)</sup>	-9999..+9999A
Battery capacity range	20..9990Ah
Operating temperature range	-20..+50°C
Readout resolution :	voltage (0..35V) ± 0.01V
current (0..200A)	± 0.1A
current (200..9999A)	± 1A
amphours (0..200Ah)	± 0.1Ah
amphours (200..9990Ah)	± 1Ah
state-of-charge (0..100%)	± 0.1%
time-to-go (0..24hrs)	± 1minute
time-to-go (24..240hrs)	± 1hr
temperature (-20..50°C) <sup>3)</sup>	± 0.5°C
Voltage measurement accuracy	± 0.3%
Current measurement accuracy	± 0.4%
Dimensions :	frontpanel ø 64mm
body diameter	ø 52mm
total depth	79mm
Weight	95grams
Shunt dimensions :	footprint 45 x 87mm
height	17mm (base) / 35mm (M8 screws)
weight	145 grams
Protection class	IP20 (frontpanel only IP 65)

*Note: the given specifications are subject to change without notice.*

<sup>1)</sup> Measured with backlight and alarm relay turned off.

<sup>2)</sup> Depends on selected shunt. With standard delivered 500A/50mV shunt (350A continuous), the range is limited to -600..+600A.

<sup>3)</sup> Only available when optional temperature sensor is connected.

## 10. Declaration of conformity



MANUFACTURER : Mastervolt International BV

ADDRESS : Snijdersbergweg 93  
1105 AN Amsterdam  
The Netherlands

Declares that the following products :

PRODUCT TYPE : BATTERY MONITOR  
MODEL : BattMan Pro

Conforms to the requirements of the following Directives of the European Union :  
EMC Directive 2004/108/EC  
RoHS Directive 2002/95/EC

The above product is in conformity with the following harmonized standards :  
EN61000-6-3: 2001 EMC - Generic Emissions Standard  
EN61000-6-2: 2005 EMC - Generic Immunity Standard

EN

# INSTALLATION GUIDE

Please read this document very carefully to avoid battery monitor malfunction and/or fire hazards!

NL

# INSTALLATIE VOORSCHRIFT

Bestudeer dit document uiterst zorgvuldig om schade aan de batterij monitor en/of brandgevaar te voorkomen!

DE

# MONTAGEANLEITUNG

Bitte lesen Sie diese Montageanleitung sorgfältig durch, damit Ihr Batterie Monitor richtig arbeitet und/oder es zu keinem Brand kommt!

FR

# INSTRUCTIONS D'INSTALLATION

Veillez les respecter scrupuleusement pour éviter tout dysfonctionnement et/ou risques d'incidents.

Mounting sequence  
Montage volgorde

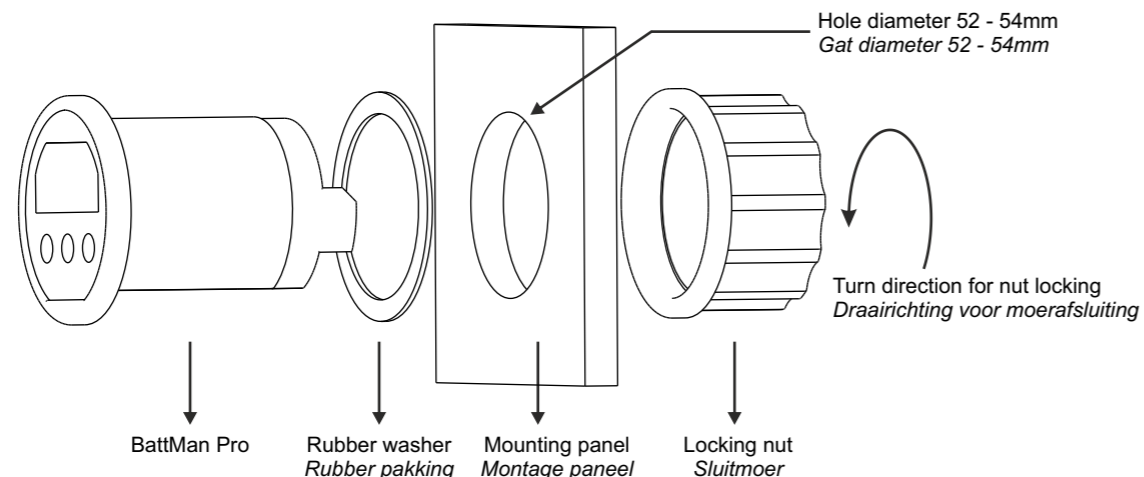

Montage Folge  
Séquence de montage

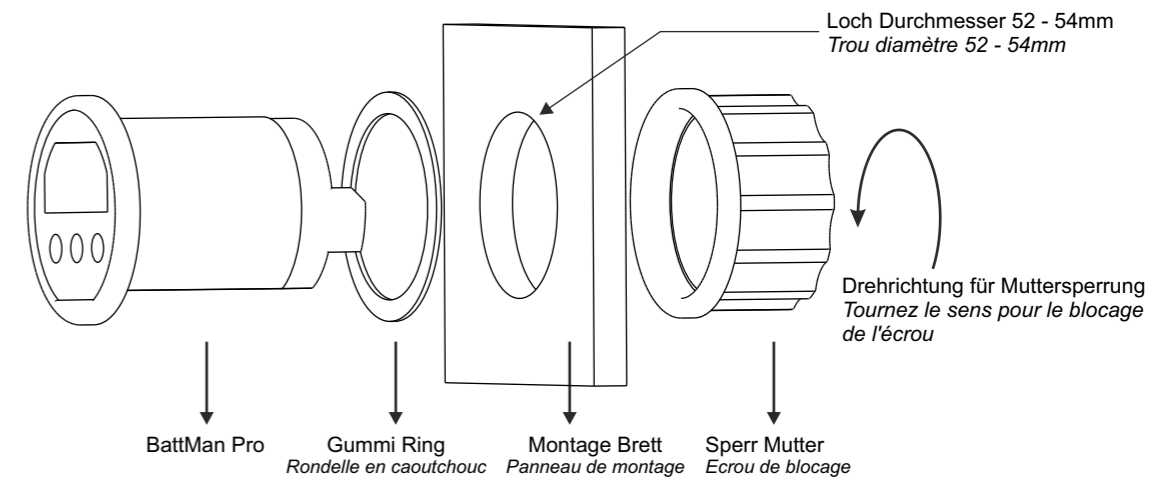

Battery positive 'MAIN' (to load e.g. charger or inverter)  
Batterij positief 'MAIN' (naar belasting b.v. lader of omvormer)

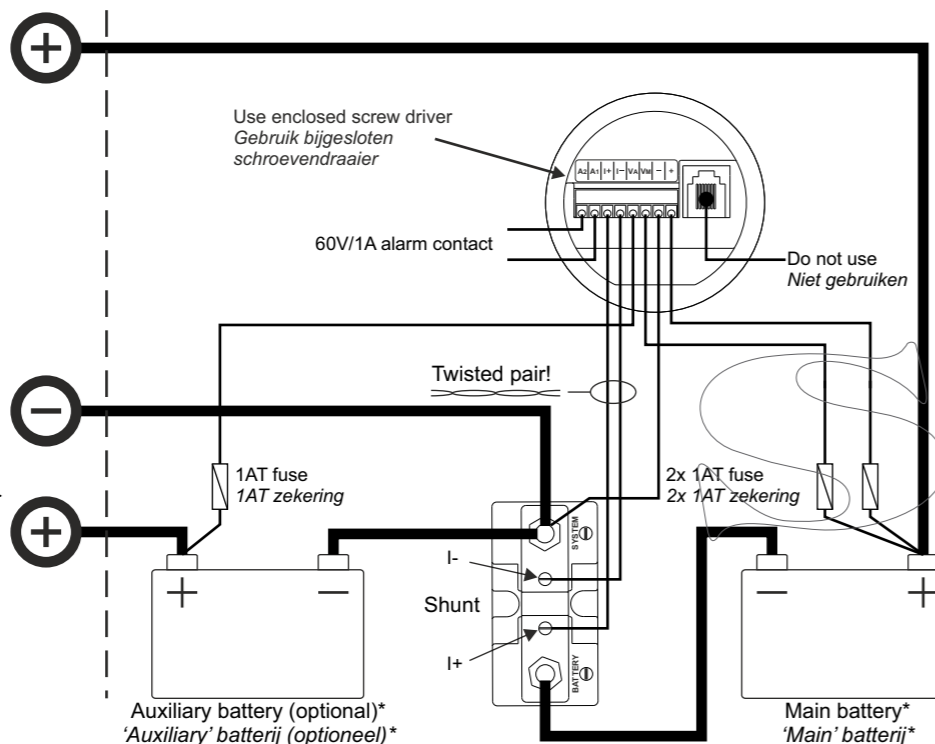

Battery negative (system ground)  
Batterij negatief (systeem min)

Battery positive 'AUX' (to load e.g. charger or starter motor)  
Batterij positief 'AUX' (naar belasting b.v. lader of startmotor)

\* Make sure the batteries you install are always in good health, preferably fully charged  
\* Installeer alleen 'gezonde', bij voorkeur reeds volledig geladen, batterijen

Batterie Pluspol 'MAIN' (zu den Verbrauchern z.B. Ladegerät oder Inverter)  
Positif batterie 'MAIN' (vers utilisations ex. Chargeur / convertisseur)

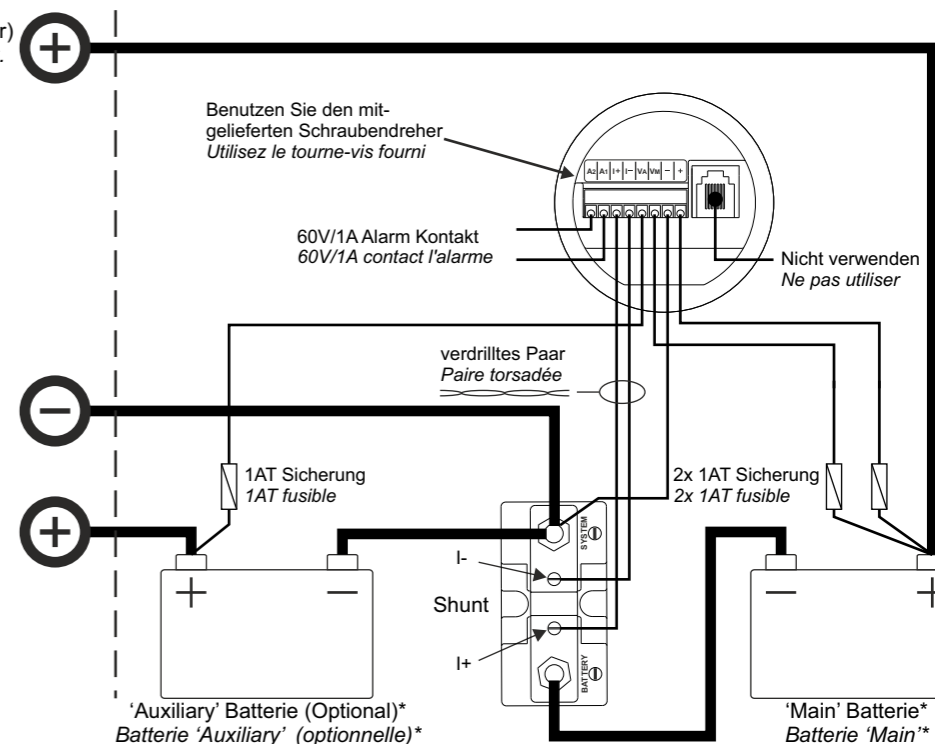

Batterie Minuspol (Systemerde)  
Négatif batterie (- système)

Batterie Pluspol 'AUX' (zu den Verbrauchern z.B. Ladegerät)  
Positif batterie 'AUX' (vers utilisations ex. Chargeur)

\* Vergewissern Sie sich, dass die von Ihnen eingebauten Batterien in gutem Zustand und am besten voll aufgeladen sind.  
\* Assurez-vous que les batteries que vous installez sont toujours saines, de préférence chargées.



The shunt must always be installed into the negative line!  
Installing the shunt into the positive line may damage the battery monitor!



All fuses must be located as close as possible to the battery terminals. Install the fuses only when all other connections are made and double checked!



All **thick** lines in the above connection diagram, represent the main current lines. These lines must be wired with a wire type which can handle the full battery current!



All thin lines (from and to battery monitor) in the above connection diagram, must have a minimum thickness of AWG24/0.2mm<sup>2</sup>. Maximum distance between battery monitor and shunt is 30 meters.



To avoid large errors in current measurement, always twist the 'I+' and 'I-' shunt lines. Connect all wires to the shunt exactly as given in the connection diagram.

Battery monitor connection terminals :

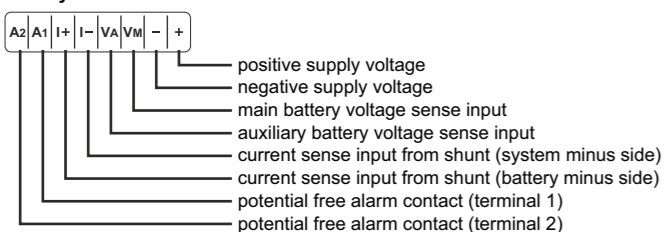

De shunt moet altijd worden opgenomen in de minleiding. De batterij monitor kan beschadigen wanneer de shunt in de plusleiding wordt opgenomen!



Alle zekeringen moeten zo dicht mogelijk bij de batterij polen geplaatst worden. Installeer de zekeringen pas wanneer alle overige aansluitingen gemaakt en nogmaals gecontroleerd zijn!



Alle **vet** getekende lijnen in bovenstaand aansluitschema geven het hoofdstroom circuit aan. Deze lijnen dienen bedraad te worden met een kabel diameter welke geschikt is voor de maximale batterij stroom.



Alle dun getekende lijnen (van en naar de batterij monitor) in bovenstaand schema, moeten minimaal een oppervlakte hebben van 0.2mm<sup>2</sup>. De maximale afstand tussen batterij monitor en shunt is 30 meter.



Om grote meetfouten te voorkomen, moeten de 'I+' en 'I-' lijnen altijd in elkaar getwist worden. Zorg ervoor dat alle Drähte mit dem Shunt auf exact to aangesloten worden zoals aangegeven in bovenstaand schema!

Battery monitor aansluitingen :

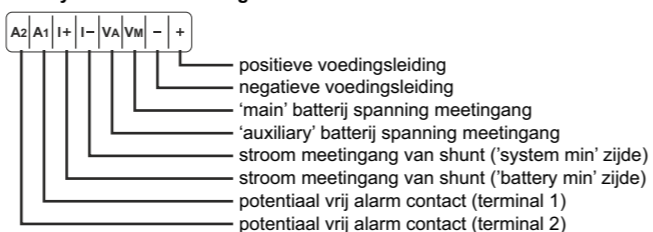

Der Shunt muß immer in die negative Hauptversorgungsleitung angebracht werden. Das Anbringen des Shunts in die positive Leitung kann den Batterie Monitor beschädigen!



Alle Sicherungen muss sich so nah wie möglich an den Batterieanschlüssen befinden. Installieren Sie die Sicherungen erst dann, wenn alle anderen Anschlüsse verbunden und überprüft wurden!



Alle dicken Linien in der obigen Anschlusszeichnung stellen die Hauptstromleitungen dar. Diese Leitungen müssen mit Kabeln gezogen werden, die mit dem vollen Batteriestrom belastet werden können!



Alle dünnen Linien (vom und zum Batteriemonitor) in der obigen Anschlusszeichnung stellen Leitungen dar, die eine Minimal Querschnitt von AWG24/0.2mm<sup>2</sup> aufweisen müssen. Die maximale Entfernung zwischen Batteriemonitor und Shunt beträgt 30 Meter.



Um größeren Fehlern in der Strommessung vorzubeugen, verdrillen Sie die Shuntleitungen 'I+' und 'I-'. Verbinden Sie alle Drähte mit dem Shunt auf genau die Weise, die in der Anschlusszeichnung angegeben wird!

Batterie Monitor Anschlussklemmen :

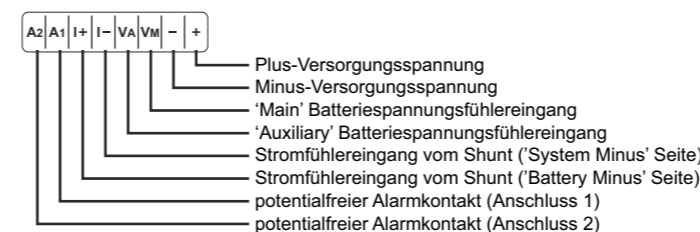

Le Shunt doit toujours être installé sur le négatif ( câble noir )! Installer le Shunt sur le positif ( câble rouge ), endommagerait le contrôleur de batterie!



Tous les fusibles doivent être situés aussi près que possible des bornes de la batterie. Installez les fusibles uniquement lorsque toutes les autres connexions sont faites et que vous les avez à nouveau vérifiées.



Toutes les lignes épaisses du diagramme de connexion, représentent les lignes de courant principal. Ces lignes doivent être câblées avec un type de câble qui peut supporter le courant de la batterie pleine!



Toutes les lignes fines (depuis et vers le moniteur de la batterie) dans le diagramme de connexion ci-dessus, doivent avoir une épaisseur minimum de AWG24/0.2mm<sup>2</sup>. La distance maximum entre le moniteur de la batterie et le shunt est 30 mètres.



Pour éviter de grosses erreurs de mesure de courant, veuillez toujours tourner les lignes shunt 'I+' et 'I-'. Connectez tous les câbles au shunt exactement comme indiqué sur le diagramme de connexion.

Raccordement de contrôleur :

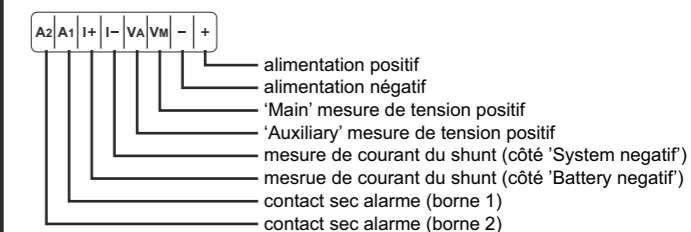

**EN QUICK START GUIDE**  
 This column describes the absolute minimum number of required steps in order to setup your Battery Monitor.

In all enclosed documents, unless otherwise stated, all settings and readout selections are related to the MAIN battery. The MAIN battery will be described as 'battery' in all following chapters including the owner's manual.

When all fuses are installed, the battery monitor will startup with a blinking display in MAIN battery voltage readout selection. When pushing one of the three buttons, the LCD stops blinking and you can navigate through all readout selections using the < or > keys. The battery monitor now operates in the Normal Operating Mode. The standard readout selection sequence is as follows :

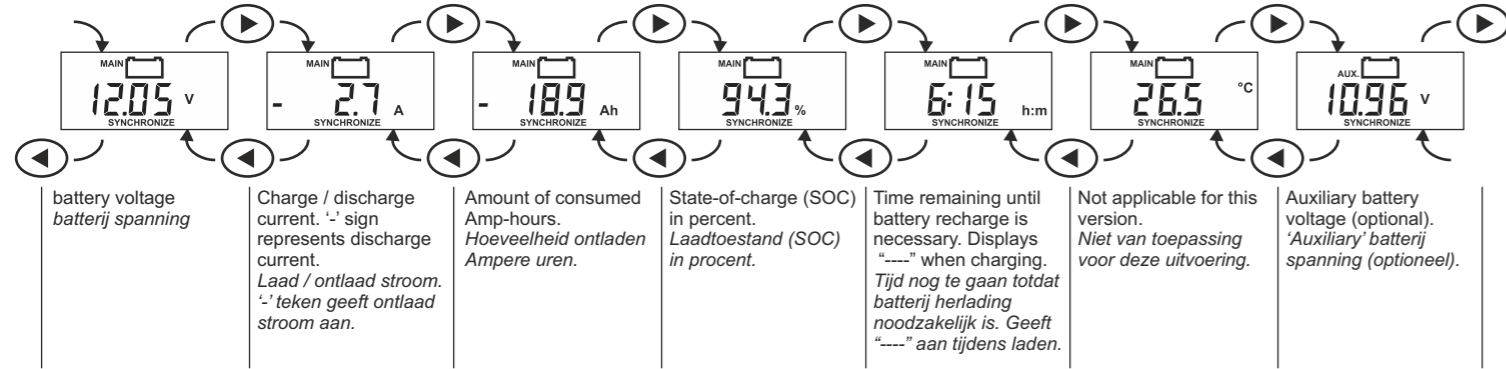

The display also indicates **SYNCHRONIZE**. As will be further explained in the owner's manual, this message means that the battery needs to be fully charged first, in order to synchronize the battery monitor with the battery. Otherwise, the State-of-charge readout will be invalid. The more often you are fully charging your batteries, the more precise the battery monitor will indicate all parameters. This will also result in a longer lifetime of your batteries.

But before the batteries can be fully charged, you first need to adjust Functions F1.0 (Charger float voltage), F2.1 (Low battery alarm on in Volts) and F5.0 (Nominal battery capacity). Setting these Functions to the right values, will in most cases result in a correctly operating battery monitoring system. However, some specific battery chargers or advanced requirements for controlling the alarm contact, might involve adjusting additional Functions. This will be explained in the enclosed owner's manual. The factory default settings are valid for a 12V battery system with a total capacity of 200Ah.

To setup the above mentioned Functions, press the MENU key for three seconds to enter the main MENU. Press the > key twice until the following display appears :



To enter the FUNCTION setup menu, press the MENU key. Now, the desired Functions can be selected by pressing the < or > keys. To alter a specific Function, press MENU again when the desired Function is selected. The value of this specific Function can then be changed by pressing the < or > keys again. When the Function is changed, press MENU again to select other Functions which needs to be changed.

When all Functions are correctly set up, the MENU key must be pressed for three seconds to save all settings and to jump back to normal operating mode again. When in setup mode no key is pressed for 90 seconds, the battery monitor will return to normal operating mode again automatically, without saving any changed setting.

Supposing your setup contains a standard battery monitor and two batteries of 12V/60Ah connected in series to become a 24V/60Ah system, the following Function settings can be implemented using the above explained method :

- a) Change Function F1.0 to the float charge voltage level of your 24V battery charger. This will typically be 26.4V.
- b) Change Function F2.1 to the voltage level at which a low battery voltage alarm must be automatically activated. For a typical 24V system, this will be 21.0V
- c) Change Function F5.0 to the nominal battery capacity value of your battery system. In this example this Function must be set to 60Ah.

When these three Functions are correctly setup, you can use the earlier explained method to save these settings and jump back to normal operating mode again. Your battery monitor is now ready to be Synchronized with your batteries, by performing a full charging cycle until the display returns the following flashing message :

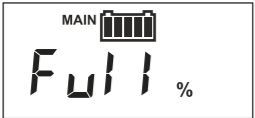

This could take several hours, depending on the State-of-charge of your batteries at the time of installation.

For further in depth explanations about the functionality of your battery monitor, please read the enclosed owner's manual.

**NL BEKNOPTE HANDLEIDING**  
 Deze kolom beschrijft het minimum aantal stappen dat ondernomen moet worden om de batterij monitor in te stellen.

In alle bijgesloten documentatie zullen, tenzij anders aangegeven, alle instellingen en uitlezingen betrekking hebben op de 'MAIN' batterij. De 'MAIN' batterij zal vanaf hier gewoon als 'batterij' aangegeven worden.

Wanneer alle zekeringen geplaatst zijn, zal de batterij monitor opstarten met een knipperend display in de 'MAIN' batterijspanningsuitlezing. Wanneer op één van de drie toetsen gedrukt wordt, zal het display stoppen met knipperen en kunt u door de verschillende uitlezingen stappen met de < of > toetsen. De batterij monitor werkt nu in de Normale-mode. De standaard volgorde van uitlezingen ziet er als volgt uit :

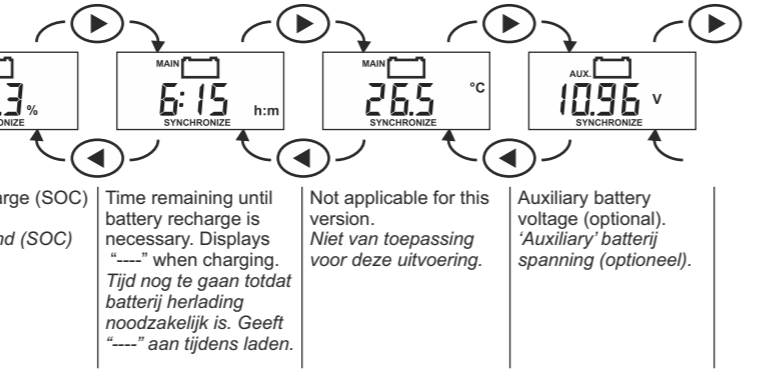

Het display toont tevens de melding **SYNCHRONIZE**. Zoals in de uitgebreidere handleiding zal worden uitgelegd, betekent deze melding dat de batterij eerst volledig opgeladen dient te worden, om de batterij monitor te kunnen synchroniseren met uw batterij. Dit is noodzakelijk voor een correcte laadtoestandsindicatie. Hoe vaker u uw batterij volledig oplaadt, hoe nauwkeuriger de batterij monitor u kan voorzien van informatie. Tevens komt dit de levensduur van uw batterij ten goede.

Maar voordat de batterij volledig geladen kan worden, dienen eerst Functies F1.0 (Float spanning van uw lader), F2.1 (Batterij leeg alarm activering in Volts) en F5.0 (Nominale batterij capaciteit) ingesteld te worden. Door deze Functies op de juiste waarden in te stellen, zal uw batterij monitoring systeem in de meeste gevallen correct opereren. Echter bij sommige specifieke batterij laders of bij geavanceerde eisen ten aanzien van sturing van het alarmcontact, kan het noodzakelijk zijn om ook andere Functies aan te passen. Dit zal worden uitgelegd in de uitgebreidere handleiding. De fabrieksinstellingen gaan uit van een 12V/200Ah batterij.

Om de bovenstaande Functies in te stellen, dient u de MENU toets voor drie seconden in te drukken om in het Main MENU te komen. Vervolgens dient u twee keer op de > toets te drukken zodat het volgende op het display valt af te lezen :



Druk op de MENU toets om in het Functie menu te komen. Nu kunnen de gewenste Functies geselecteerd worden middels de < en > toetsen. Om een specifieke Functie te wijzigen, drukt u na selectie nogmaals op de MENU toets. De waarde van deze Functie kan nu gewijzigd worden middels de < en > toetsen. Wanneer de Functie is gewijzigd, kan er wederom op MENU gedrukt worden om eventueel andere Functies te wijzigen.

Wanneer de noodzakelijke Functies gewijzigd zijn, worden deze door drie seconden op de MENU toets te drukken, opgeslagen in het geheugen waarna wordt teruggekeerd in de Normale-mode. Hetzelfde treedt op als er 90 seconden geen activiteit is waargenomen. Echter dan wel zonder opslag van enige Functie wijzigingen in het geheugen.

Uitgaande van een voorbeeld systeem bestaande uit de standaard batterij monitor en twee 12V/60Ah batterijen in serie, dus 24V/60Ah in totaal, moeten de volgende Functie wijzigingen worden doorgevoerd, volgens bovenstaande methode :

- a) Wijzig Functie F1.0 naar het juiste 'Float' spanningsniveau van uw 24V batterij lader. Een typische waarde hiervoor is 26.4V.
- b) Wijzig Functie F2.1 naar het spanningsniveau waarbij automatisch een batterij leeg alarm geactiveerd moet worden. Een typische waarde hiervoor is 21.0V.
- c) Wijzig Functie F5.0 naar de nominale capaciteitswaarde van uw batterij systeem. In dit voorbeeld moet deze waarde gewijzigd worden naar 60Ah.

Wanneer de drie Functies gewijzigd zijn, kunnen deze opgeslagen worden om vervolgens terug te keren naar de Normale-mode. Uw batterij monitor is nu gereed om gesynchroniseerd te worden met uw batterijen, door een volledig laadproces te doorlopen totdat het display de volgende knipperende uitlezing toont :

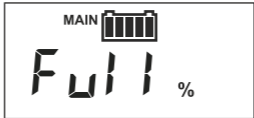

Dit proces kan enkele uren duren al naar gelang de laadstatus van uw batterijen tijdens de installatie.

Voor een uitgebreidere uitleg betreffende de functionaliteit van uw batterij monitor, leest u aub de bijgesloten gebruikers handleiding.

**DE SCHNELLSTARTANLEITUNG**  
 Dieser Abschnitt beschreibt alle Installationsschritte, die mindestens benötigt werden, um Ihren Batteriemonitor einzubauen.

In allen mitgelieferten Dokumenten beziehen sich alle Einstellungen und Anzeigen auf die 'MAIN' Batterie, es sei denn anders angegeben. Die 'MAIN' Batterie wird in allen folgenden Abschnitten als „Batterie“ bezeichnet.

Wenn alle Sicherungen eingebaut sind, geht der Batteriemonitor mit blinkender Anzeige der 'MAIN' Batteriespannung an. Wenn Sie eine der drei Tasten betätigen, hört die LCD-Anzeige auf zu blinken und Sie können mit Hilfe der Taste < und > einen Anzeigemodus wählen. Der Batteriemonitor arbeitet nun im normalen Betriebsmodus. Die Standardanzeigeauswahl wird in folgender Reihenfolge eingestellt :

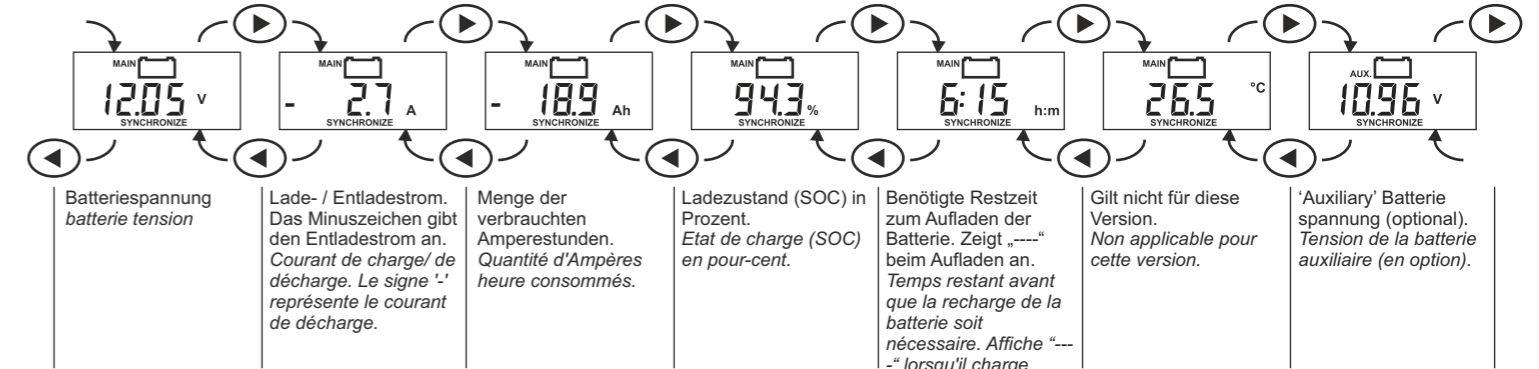

In der Anzeige erscheint ebenfalls **SYNCHRONIZE**. Wie in der Bedienungsanleitung genauer erklärt wird, bedeutet diese Anzeige, dass die Batterie zunächst voll aufgeladen werden muss, um den Batteriemonitor mit der Batterie zu synchronisieren. Andernfalls ist die Anzeige des Ladezustands ungültig. Je häufiger die Batterien vollständig aufgeladen werden, desto genauer zeigt der Batteriemonitor alle Parameter an. Außerdem verlängert dies die Lebensdauer Ihrer Batterien.

Bevor die Batterien allerdings vollständig aufgeladen können, müssen Sie die Funktionen F1.0 (Erhaltungsstufespannung), F2.1 (Niedrigspannungsalarm in Volt) und F5.0 (Nominale Batteriekapazität) einstellen. Indem diese Funktionen auf die richtigen Werte eingestellt werden, wird in der Regel sicher gestellt das Ihr Batteriemonitorsystem einwandfrei funktioniert. Bei bestimmten Batterieladern oder fortgeschrittenen Anforderungen für Alarmkontakte sind u. U. weitere Funktionseinstellungen nötig. Diese werden im Detail in der mitgelieferten Bedienungsanleitung erläutert. Die Werks-einstellungen des Batteriemonitors sind voreingestellt für ein 12V/200Ah Batteriesystem.

Zum Einstellen der oben beschriebenen Funktionen, halten Sie die MENU-Taste für 3 Sekunden gedrückt und Sie gelangen in das Hauptmenü. Betätigen Sie die > Taste zweimal bis folgende Anzeige erscheint :



Um ins Funktionseinstellungsmenü zu gelangen, betätigen Sie bitte die MENU-Taste. Hier können Sie dann die gewünschten Funktionen mithilfe der Tasten < und > auswählen. Wenn Sie die gewünschte Funktion gefunden haben, betätigen Sie die MENU-Taste erneut. Die betreffende Funktion kann mithilfe der Tasten < und > eingestellt werden. Nachdem Sie die Funktion neu eingestellt haben, betätigen Sie die MENU-Taste erneut, um weitere Funktionen zu verändern.

Nachdem alle Funktionen richtig eingestellt wurden, drücken Sie die MENU-Taste für drei Sekunden und Sie gelangen in den normalen Betriebsmodus zurück mit gespeicherten Funktionswerten. Wenn im Einstellungsmodus für mehr als 90 Sekunden keine Taste gedrückt wird, geht der Batteriemonitor automatisch in den normalen Betriebsmodus zurück ohne bereits gemachte Einstellungen abzuspeichern.

Angenommen Ihr System besteht aus ein Standard Batterie Monitor und zwei 12V/60Ah Batterien, die zu einem 24V/60Ah-System in Reihe geschaltet wurden, dann benutzen Sie bitte die folgenden Funktionseinstellungen in der oben beschriebenen Weise :

- a) Stellen Sie die Funktion F1.0 auf das Erhaltungsstufe- oder 'Float' Spannungsniveau Ihres 24V Batterieladers. Dies ist normalerweise 26,4V.
- b) Stellen Sie die Funktion F2.1 auf das Spannungsniveau bei dem ein Niedrigspannungsalarm ausgelöst werden soll. Für ein normales 24V-System ist das 21,0V.
- c) Stellen Sie die Funktion F5.0 auf die nominale Batteriekapazität Ihres Batteriesystems. In diesem Beispiel muss diese Funktion auf 60Ah gestellt werden.

Nachdem alle drei Funktionen richtig eingestellt wurden, können diese gespeichert werden um wieder zurückzugelangen in den normalen Betriebsmodus. Ihr Batterie-monitor ist nun bereit für eine Synchronisation mit Ihren Batterien, indem ein vollständiger Ladezyklus durchgeführt wird bis die folgende blinkende Nachricht erscheint :

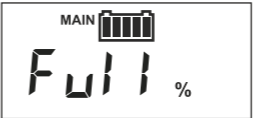

Je nach Ladezustand beim Einbau der Batterien kann dies bis zu mehrere Stunden benötigen.

Für weitere Erläuterungen zur Funktionalität des Batteriemonitors lesen Sie bitte die mitgelieferte Bedienungsanleitung.

**FR GUIDE DE DEMARRAGE RAPIDE**  
 Cette rubrique décrit le nombre minimum absolu des étapes requises pour installer votre Moniteur de Batterie.

Dans tous les documents fournis, à moins qu'il en soit spécifié autrement, tous les réglages et les sélections d'affichage sont en relation avec la batterie 'MAIN'. La batterie 'MAIN' sera décrite comme 'batterie' dans les chapitres suivants:

Lorsque tous les fusibles sont installés, le moniteur de la batterie démarrera par un affichage clignotant dans la sélection de l'affichage de tension de la batterie 'MAIN'. Lorsque vous appuyez sur un des trois boutons, le LCD s'arrête de clignoter et vous pouvez naviguer dans toutes les sélections d'affichage à l'aide des touches < ou >. Le moniteur de la batterie fonctionne maintenant sous le Mode d'Opération Normale. La séquence de sélection d'affichage standard est la suivante :

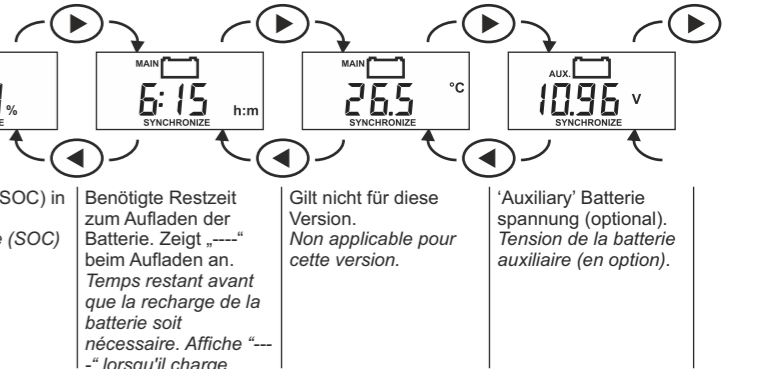

L'affichage indique aussi **SYNCHRONIZE**. Comme il sera expliqué plus loin dans le manuel de l'utilisateur, ce message signifie que la batterie à besoin d'être d'abord complètement chargée afin de synchroniser le moniteur de batterie et la batterie. Sinon, l'affichage de l'état de charge ne sera pas valide. Plus vous chargez la batterie, plus le moniteur de batterie indiquera tous les paramètres les plus précis. Cela permettra aussi d'augmenter la durée de vie de vos batteries.

Cependant, avant de pouvoir charger complètement les batteries, vous devez d'abord régler les Fonctions F1.0 (Tension float du chargeur), F2.1 (Alarme On batterie faible en Volts) et F5.0 (capacité nominale de la batterie). En réglant ces fonctions aux bonnes valeurs, le système de contrôle de la batterie fonctionnera, dans la plupart des cas, correctement. Cependant, des chargeurs de batterie spécifiques ou des exigences avancées de contrôle du contact de l'alarme, peuvent impliquer de régler d'autres Fonctions. Cela sera expliqué dans le manuel de l'utilisateur fourni. Les réglages d'usine par défaut sont valables pour le système de batterie 12V d'une capacité totale de 200Ah.

Pour régler les Fonctions mentionnées ci-dessus, appuyez sur la touche MENU pendant trois secondes pour accéder au MENU principal. Appuyez à deux reprises sur la touche > jusqu'à ce que l'affichage suivant apparaisse:



Pour accéder au menu de réglage Fonction, appuyez sur la touche MENU. Ensuite, les Fonctions désirées peuvent être sélectionnées en appuyant sur les touches < ou >. Pour modifier une Fonction spécifique, appuyez à nouveau sur MENU lorsque la Fonction désirée est sélectionnée. La valeur de cette Fonction spécifique peut ensuite être changée en appuyant à nouveau sur les touches < ou >. Lorsque la Fonction est modifiée, appuyez à nouveau sur MENU pour sélectionner d'autres Fonctions qui auraient besoin d'être changées.

Lorsque toutes les Fonctions sont correctement réglées, la touche MENU doit être enfoncée pendant trois secondes pour sauvegarder tous les réglages et pour retourner au mode d'opération normal. Lorsque aucune touche n'est enfoncée pendant 90 en mode réglage, le moniteur de batterie retourne automatiquement au mode d'opération normal, sans sauvegarder le réglage modifié.

En supposant que le réglage de la batterie contient une contrôleur standard et deux piles de 12V/60Ah connectées en série pour devenir un système 24V/60Ah, les réglages de Fonction suivants peuvent être effectués en utilisant la méthode expliquée ci-dessus :

- a) Changez la Fonction F1.0 en niveau de tension de charge float de votre chargeur de batterie 24V. Cela donnera 26.4V typique.
- b) Changez la Fonction F2.1 en niveau de tension sur lequel une alarme de tension batterie faible doit être automatiquement activée. Pour un système typique 24V, cela donnera 21.0V
- c) Changez la Fonction F5.0 en valeur capacité nominale de la batterie de votre système de batterie. Dans cet exemple, la Fonction doit être réglée sur 60Ah.

Lorsque ces trois Fonctions sont correctement réglées, vous pouvez utiliser la méthode précédemment expliquée pour sauvegarder ces réglages et retourner au mode d'opération normale. Votre moniteur de batterie est maintenant prêt à être Synchronisé avec les batteries, en effectuant un cycle de charge complet jusqu'à ce que l'affichage retourne au message clignotant suivant :

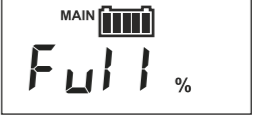

Cela peut prendre plusieurs heures, en fonction de l'Etat de charge de vos batteries au moment de l'installation. Pour plus d'informations détaillées à propos de cette fonctionnalité de votre moniteur de batterie, veuillez lire le manuel de l'utilisateur fourni.



### General battery precautions :

1. Have someone within range of your voice or close enough to come to your aid when you work near a lead-acid battery.
2. Have plenty of fresh water and soap nearby in case battery acid contacts skin, clothing, or eyes.
3. Wear proper, non-absorbent gloves, complete eye protection, and clothing protection. Avoid touching your eyes and wiping your forehead while working near batteries.
4. If battery acid contacts skin or clothing, wash immediately with soap and water. If acid enters your eye, immediately flood it with running cold water for at least 15 minutes and get medical attention immediately.
5. Never smoke or allow a spark or flame near batteries.
6. Use extra caution to reduce the risk of dropping a metal tool on the battery. It could spark or short circuit the battery or other electrical parts and could cause an explosion.
7. Remove all personal metal items, like rings, bracelets, and watches when working with batteries. Batteries can produce a short circuit current high enough to weld metal to skin, causing a severe burn.
8. If you need to remove a battery, always remove the ground terminal from the battery first. Make sure all accessories are off so you don't cause an arc.
9. Never charge a frozen battery.
10. Make sure the area around the battery is well ventilated while charging. Make sure the voltage of the battery matches the output voltage of the battery charger. Study all battery manufacturer's recommendations for further specific precautions such as whether equalization is acceptable for your battery or not, and recommended rates of charge.



### Allgemeine Sicherheitsvorschriften für Batterien :

1. Wenn Sie in der Umgebung von Bleibatterien arbeiten, sollte immer eine weitere Person in Ihrer Nähe oder Rufweite sein, um Ihnen im Notfall Hilfe leisten zu können.
2. Bewahren Sie ausreichend Wasser und Seife griffbereit auf für den Fall, dass die Batteriesäure in Kontakt mit Haut, Kleidung oder Augen kommt.
3. Tragen Sie geeignete, wasserabstoßende Handschuhe, vollständigen Augenschutz und Schutzkleidung. Vermeiden Sie es, während der Arbeit in der Nähe der Batterien Ihre Augen oder Stirn abzuwischen.
4. Falls Ihre Haut oder Kleidung in Kontakt mit der Batteriesäure kommt, sofort mit Seife und Wasser abwaschen. Bei Augenkontakt sofort mit fließendem kaltem Wasser für 15 Minuten ausspülen; suchen Sie umgehend einen Arzt auf.
5. In der Nähe von Batterien nicht rauchen; Funken und Flammen sind verboten.
6. Sorgen Sie dafür, dass keine Metallgegenstände auf die Batterie fallen. Dadurch könnten Funken entstehen oder die Batterie oder andere elektrische Teile kurzgeschlossen werden, wodurch wiederum eine Explosion verursacht werden könnte.
7. Legen Sie beim Umgang mit Batterien alle persönlichen Schmucksachen wie Ringe, Armreifen und Uhren ab. Batterien können einen Kurzschluss verursachen, dessen Stromstärke stark genug ist, um Metall auf der Haut schmelzen zu lassen und somit schwerwiegende Verbrennungen zu verursachen.
8. Wenn Sie eine Batterie entfernen müssen, entfernen Sie zunächst den Erdungskontakt von der Batterie. Vergewissern Sie sich, dass jegliches Zubehör aus ist, damit kein Funkenschlag verursacht wird.
9. Niemals gefrorene Batterien aufladen.
10. Sorgen Sie während des Aufladens für ausreichende Belüftung um die Batterie herum. Vergewissern Sie sich, dass die Batteriespannung mit der Ausgangsspannung des Ladegeräts übereinstimmt. Lesen Sie alle Empfehlungen des Batterieherstellers, um weitere Sicherheitsinformationen über den empfohlenen Ladestrom oder darüber zu erhalten, ob ein Ladungsausgleich für Ihre Batterie zulässig ist.