



NSS evo2

# Operator Manual

ENGLISH

SVWB



SWIB

# Preface

---

## Disclaimer

As Navico is continuously improving this product, we retain the right to make changes to the product at any time which may not be reflected in this version of the manual. Please contact your nearest distributor if you require any further assistance.

It is the owner's sole responsibility to install and use the equipment in a manner that will not cause accidents, personal injury or property damage. The user of this product is solely responsible for observing safe boating practices.

NAVICO HOLDING AS AND ITS SUBSIDIARIES, BRANCHES AND AFFILIATES DISCLAIM ALL LIABILITY FOR ANY USE OF THIS PRODUCT IN A WAY THAT MAY CAUSE ACCIDENTS, DAMAGE OR THAT MAY VIOLATE THE LAW.

Governing Language: This statement, any instruction manuals, user guides and other information relating to the product (Documentation) may be translated to, or has been translated from, another language (Translation). In the event of any conflict between any Translation of the Documentation, the English language version of the Documentation will be the official version of the Documentation.

This manual represents the product as at the time of printing. Navico Holding AS and its subsidiaries, branches and affiliates reserve the right to make changes to specifications without notice.

## Trademarks

Lowrance® and Navico® are registered trademarks of Navico.

Fishing Hot Spots® is a registered trademark of Fishing Hot Spots Inc. Copyright© 2012 Fishing Hot Spots.

Navionics® is a registered trademark of Navionics, Inc.

NMEA 2000® is a registered trademark of the National Marine Electronics Association.

SiriusXM® is a registered trademark of Sirius XM Radio Inc.

FUSION-Link™ Marine Entertainment Standard™ is a registered trademark of FUSION Electronics Ltd.

The terms HDMI and HDMI High-Definition Multimedia Interface, and the HDMI Logo are trademarks or registered trademarks of HDMI Licensing LLC in the United States and other countries.

SD™ and microSD™ are trademarks or registered trademarks of SD-3C, LLC in the United States, other countries or both.

Wi-Fi® is a registered trademark of the Wi-Fi Alliance®.

Additional mapping data: Copyright© 2012 NSI, Inc.: Copyright© 2012 by Richardson's Maptech.

## Navico product references

This manual can refer to the following Navico products:

- Broadband Radar™ (Broadband Radar)
- Broadband 3G™ Radar (Broadband 3G Radar)
- Broadband 4G™ Radar (Broadband 4G Radar)
- DownScan Imaging™ (DownScan)
- DownScan Overlay™ (Overlay)
- ForwardScan™ (ForwardScan)
- GoFree™ (GoFree)
- Halo™ Pulse Compression Radar (Halo Radar)
- SonicHub® (SonicHub)
- StructureMap™ (StructureMap)
- StructureScan® (StructureScan)
- StructureScan® HD (StructureScan HD)

## Copyright

Copyright © 2015 Navico Holding AS.

## Warranty

The warranty card is supplied as a separate document.

In case of any queries, refer to the brand website of your display or system: [simrad-yachting.com](http://simrad-yachting.com).

## Regulatory statements

This equipment is intended for use in international waters as well as coastal sea areas administered by countries of the E.U. and E.E.A.

The NSS evo2 complies with:

- CE under R&TTE directive 1999/5/EC
- The requirements of level 2 devices of the Radiocommunications (Electromagnetic Compatibility) standard 2008

The relevant Declaration of conformity is available in the NSS evo2 section on the following website: [simrad-yachting.com](http://simrad-yachting.com).

## About this manual

This manual is a reference guide for operating the NSS evo2. It assumes that all equipment is installed and configured, and that the system is ready to use.

The manual assumes that the user has basic knowledge of navigation, nautical terminology and practices.

Important text that requires special attention from the reader is emphasized as follows:

→ **Note:** Used to draw the reader's attention to a comment or some important information.

**Warning:** Used when it is necessary to warn personnel that they should proceed carefully to prevent risk of injury and/or damage to equipment/personnel.

### Manual version

This manual is written for the NSS evo2 software version 3.0. The manual is continuously updated to match new software releases. The latest available manual version can be downloaded from [simrad-yachting.com](http://simrad-yachting.com).

## Viewing the manual on the screen

The pdf viewer included in the NSS evo2 makes it possible to read the manuals and other pdf files on the screen. Manuals can be downloaded from [simrad-yachting.com](http://simrad-yachting.com).

The manuals can be read from a card inserted in the card reader or copied to the unit's internal memory.

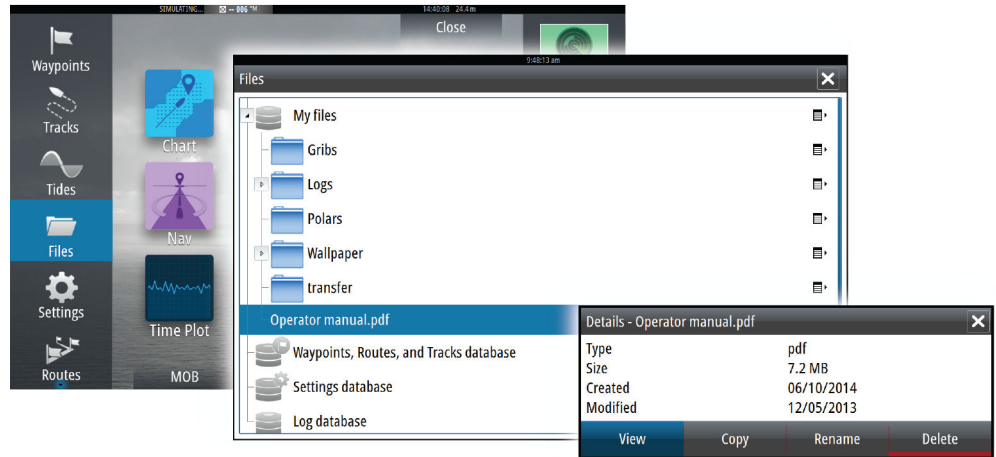

Use the menu options or the keys and on-screen buttons to maneuver in the pdf file as described below:

- Search, Goto page, Page Up and Down  
Select the relevant panel button.
- Scroll pages  
Turn the rotary knob.
- Panning on the page  
Drag finger on the screen in any direction.
- Zoom In/Out  
Use pinch or spread gestures.
- Exit the pdf viewer  
Press the **X** key or select the **X** in the upper right corner of the panel.

## The Software version

The software version currently on this unit can be found in the About dialog. The About dialog is available in the System Settings.

For information regarding upgrading your software, refer to "*Software upgrades*" on page 114.

# Contents

---

## 10 Introduction

- 10 The front panel and keys
- 11 The Home page
- 12 Application pages
- 13 Integration of 3<sup>rd</sup> party devices
- 14 Remote controllers

## 15 Basic operation

- 15 Turning the system on and off
- 15 Display illumination
- 15 Locking the touchscreen
- 15 Touchscreen operation
- 16 Using menus and dialogs
- 17 Selecting pages and panels
- 17 Creating a Man Overboard waypoint
- 17 Screen capture

## 18 Customizing your system

- 18 Customizing the Home page wallpaper
- 18 Adjusting panel size
- 18 Password protection
- 19 Adding new favorite pages
- 19 Edit favorite pages
- 19 Setting the appearance of the Instrument bar
- 21 Bridge Control

## 23 Charts

- 23 The Chart panel
- 23 Chart data
- 23 Showing dual chart types
- 24 Panning the chart
- 24 Chart scale
- 24 Vessel symbol
- 24 Positioning the vessel on the chart panel
- 25 Displaying information about chart items
- 25 Using the cursor on the chart panel
- 25 Saving waypoints
- 26 Creating routes
- 26 Measuring distance
- 26 Find objects on chart panels
- 27 3D charts
- 27 Chart overlay
- 27 Insight charts
- 28 Navionics charts
- 31 Jeppesen charts
- 34 Chart settings

## 36 Waypoints, Routes, and Tracks

- 36 Waypoints
- 37 Routes
- 39 Tracks
- 40 Waypoints, Routes, and Tracks dialogs

## 41 Navigating

- 41 Navigation panels
- 42 Navigate to cursor position
- 42 Navigate a route

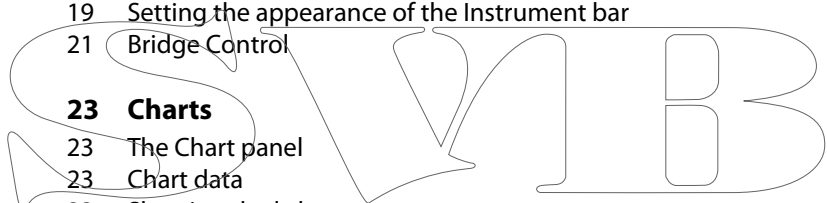

43	Navigating with the autopilot
43	Navigation settings
<b>45</b>	<b>Autopilot</b>
45	Safe operation with the autopilot
45	Activating the autopilot
45	Switching from automatic mode to manual steering
45	Autopilot indication on the pages
46	The Autopilot panel
47	Mode overview
47	Standby mode
47	Non-Follow Up (NFU, Power steering)
47	Follow-up steering (FU)
48	AUTO mode (auto compass)
48	NoDrift mode
49	NAV mode
50	WIND mode
51	WIND Nav mode
51	Turn pattern steering
53	Using the NSS evo2 in an AP24/AP28 system
53	Using the autopilot in an EVC system
54	Autopilot settings
<b>57</b>	<b>Radar</b>
57	The radar panel
57	Dual radar
58	Radar overlay
58	Radar operational modes
58	Radar Range
59	Using the cursor on a radar panel
59	Saving waypoints
60	Radar sector blanking
60	Adjusting the radar image
62	Advanced radar options
63	Radar view options
64	EBL/VRM markers
64	Setting a guard zone around your vessel
65	MARPA targets
66	Recording radar data
66	Radar settings
<b>68</b>	<b>Echosounder</b>
68	The Echosounder image
68	Zooming the Echosounder image
69	Using the cursor on the Echosounder panel
70	Saving waypoints
70	Viewing Echosounder history
70	Setting up the Echosounder image
71	Advanced Echosounder options
72	Start recording log data
73	Stop recording log data
73	Viewing the recorded sounder data
73	Echosounder View options
75	Echosounder settings
<b>76</b>	<b>StructureScan</b>
76	The StructureScan image
76	Zooming the StructureScan image
76	Using the cursor on the StructureScan panel

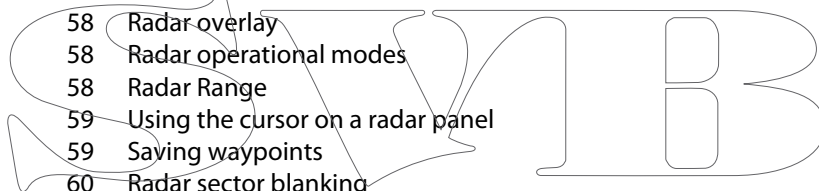

77	Saving waypoints
78	Viewing StructureScan history
78	Setting up the StructureScan image
79	Advanced StructureScan settings
<b>80</b>	<b>StructureMap</b>
80	The StructureMap image
80	Activating Structure overlay
80	StructureMap sources
81	StructureMap tips
81	Recording StructureScan data
81	Using StructureMap with mapping cards
81	Structure options
<b>83</b>	<b>ForwardScan</b>
83	The ForwardScan image
84	Setting up the ForwardScan image
84	ForwardScan view options
84	Heading extension
85	ForwardScan setup
<b>87</b>	<b>Wireless connection</b>
87	Connect and disconnect from a wireless hotspot
87	GoFree Shop
87	GoFree Controller & Viewer
88	Uploading log files to Insight Genesis
88	Wireless settings
<b>90</b>	<b>AIS</b>
90	AIS target symbols
90	Viewing information about AIS targets
91	Calling an AIS vessel
91	AIS SART
92	Vessel alarms
93	Vessel settings
<b>95</b>	<b>Instrument panels</b>
95	Dashboards
95	Customizing the Instruments panel
<b>96</b>	<b>Audio</b>
96	Enabling audio
96	The Audio panel
97	Setting up the audio system
98	Operating the audio system
98	Favorite channels
98	Sirius radio (North America only)
<b>99</b>	<b>Weather</b>
99	Wind barbs
99	Showing weather details
99	GRIB weather
101	SiriusXM weather
103	Weather alarms
<b>104</b>	<b>Video</b>
104	The Video panel
104	Setting up the video panel

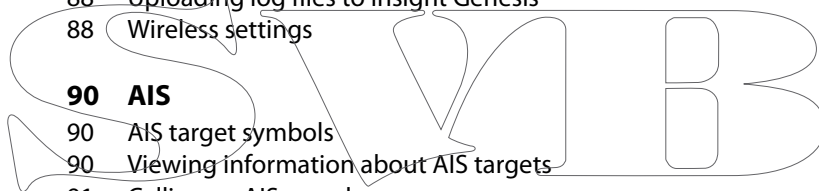



104 FLIR camera control

### **106 Time plots**

106 The Time plot panel

106 Selecting data

### **107 Alarms**

107 Alarm system

107 Type of messages

107 Single alarms

107 Multiple alarms

107 Acknowledging a message

108 Alarms dialog

### **109 Tools**

109 Waypoints/routes/tracks

109 Tides

109 Alarms

109 Settings

109 Vessels

109 Sun, Moon

109 Trip calculator

109 Files

110 Find

### **111 Simulator**

111 Demo mode

111 Simulator source files

111 Advanced simulator settings

### **113 Maintenance**

113 Preventive maintenance

113 Cleaning the display unit

113 Cleaning the media port door

113 Checking the keys

113 Checking the connectors

113 NMEA Data logging

114 Software upgrades

114 Backing up your system data

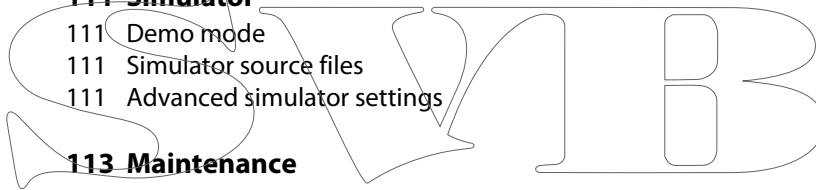

# 1

## Introduction

### The front panel and keys

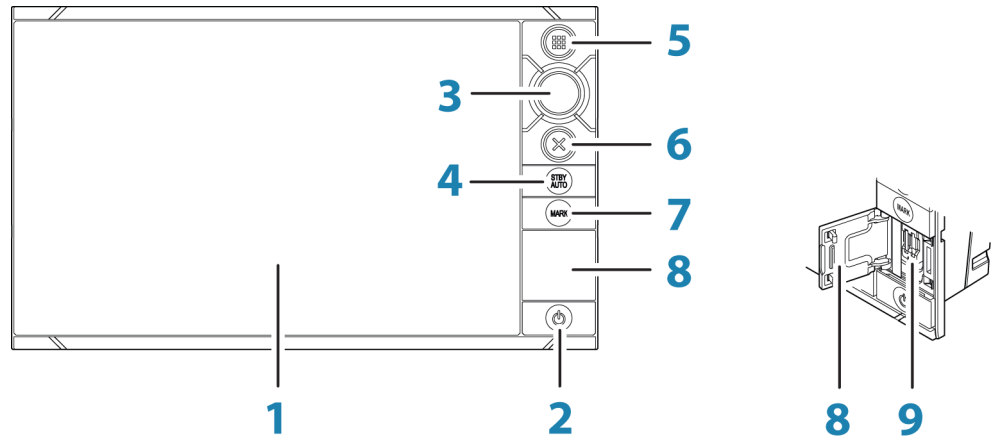

**1 Touch screen**

**2 Power key**

Press once to display the System controls dialog.  
Repeat short presses to cycle the backlight brightness.  
Press and hold to turn the unit ON/OFF.

**3 Rotary knob**

Rotate to scroll through menu items, then press to confirm a selection.  
Rotate to adjust a value.  
Rotate to zoom a zoomable panel.

**4 STBY / AUTO key**

With the autopilot in any automatic mode: Press to set the autopilot to Standby mode.  
With the autopilot in Standby mode: Press to display the autopilot mode selection pop-up.

**5 Home key**

Press once to activate the Home page. Repeat short presses to cycle the favorite buttons.  
Press and hold to display the Favorite panel as an overlay on active page. Repeat short presses to cycle the favorite buttons.

**6 X key**

Press once to exit a dialog, to return to previous menu level and to remove the cursor from the panel.

**7 MARK key**

With cursor active on the panel: Press to immediately save a waypoint at cursor position.  
With no active cursor: Press to immediately save a waypoint at vessel position.  
Press and hold to display the Plot menu used for saving new waypoints, routes and tracks.

**8 Card reader door**

**9 Micro-SD Card readers**

→ **Note:** The MARK key is not available on 7" units.

## The Home page

The **Home** page is accessed from any operation by a short press on the **Home** key.



### 1 Applications

Select a button to display the application as a full page panel.  
Press and hold a button to display pre-configured split page options for the application.

### 2 Tools

Select a button to access dialogs used for carrying out a task, or for browsing stored information.

### 3 Close button

Select to exit the **Home** page and return to the previous active page.

### 4 Favorites

Select a button to display the panel combination.  
Press and hold a favorite button to enter edit mode for the Favorites panel.

### 5 Man Over Board (MOB) button

Select to save a Man Over Board (MOB) waypoint at the current vessel position.

## Application pages

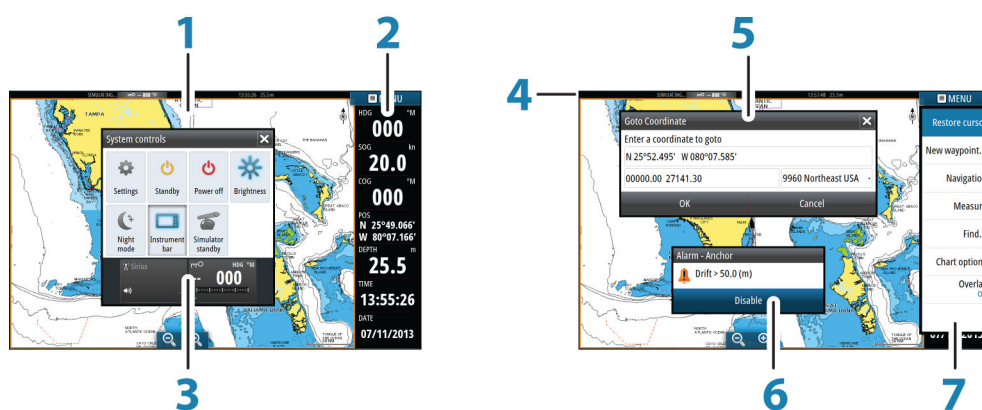

Each application connected to the system is presented on panels. The application can be presented as a full page, or in combination with other panels in a multiple panel page. All application pages are accessed from the **Home** page.

**1 Application panel**

**2 Instrument bar**

Navigation and sensor information. The bar can be turned off and it can be configured by the user.

**3 System controls dialog**

Quick access to basic system settings.

Display the dialog by a short press on the **Power** key or by swiping down from top of the screen.

**4 Status bar**

**5 Dialog**

Information to or input from the user.

**6 Alarm message**

Displayed if dangerous situations or system faults occur.

**7 Menu**

Panel specific menu.

Display the menu by selecting the **MENU** panel button, or by pressing the **MENU** key on an OP40 controller.

### Split pages

You can have several panels on one page depending on screen size:

- 7" units: 2 panels
- 9", 12" and 16" units: 4 panels

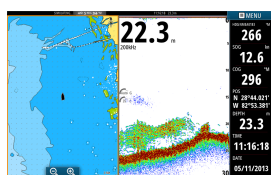

2 panels page

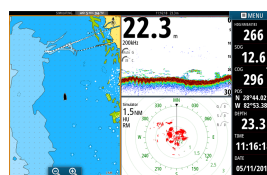

3 panels page

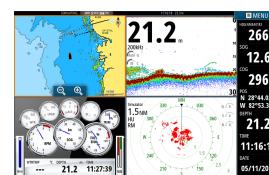

4 panels page

Panel sizes in a split page can be adjusted from the **System Controls** dialog.

→ **Note:** Mercury features, if enabled, do not allow split pages.

## Pre-configured split pages

Each full screen application has several pre-configured split pages, featuring the selected application combined with each of the other panels.

- **Note:** The number of pre-configured split pages cannot be changed, and the pages cannot be customized or deleted.

Access a pre-configured split page by pressing and holding the main panel button.

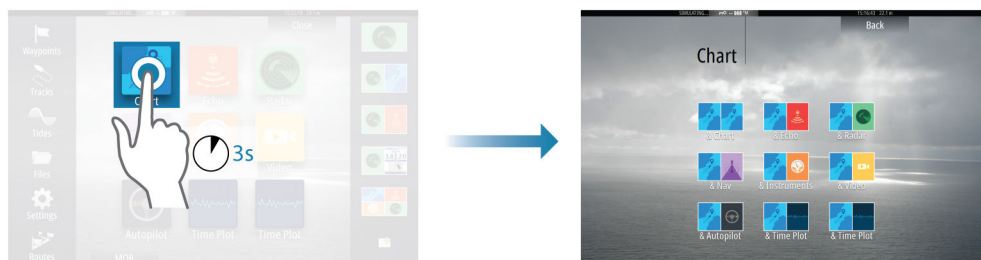

## Favorite pages

All preconfigured favorite pages can be modified and deleted, and you can create your own. You can have a total of 12 favorite pages.

For more information, refer to *"Adding new favorite pages"* on page 19.

## Integration of 3<sup>rd</sup> party devices

Several 3<sup>rd</sup> party devices can be connected to the NSS evo2. The applications are displayed on separate panels or integrated with other panels.

A device connected to the NMEA 2000 network should automatically be identified by the system. If not, enable the feature from the advanced option in the System settings dialog.

The 3<sup>rd</sup> party device is operated by using menus and dialogs as on other panels.

This manual does not include specific operation instructions for any 3<sup>rd</sup> party device. For features and functionality, refer to the documentation included with the 3<sup>rd</sup> party device.

### SmartCraft VesselView integration

SmartCraft data can be displayed and interaction are enabled through the NSS evo2 when a VesselView 7 or VesselView 4 gateway device is present on the network.

The engine supplier icon appears on the **Home** page when a device is available.

### FUSION-Link integration

FUSION-Link devices connected to the NMEA 2000 network can be controlled from the NSS evo2 system.

The FUSION-Link devices appear as additional sources when using the audio function. No additional icons are available.

Refer to *"Audio"* on page 96 for more information.

### FLIR camera integration

If a FLIR camera is available on the Ethernet network, you can display the video and control the camera from the NSS evo2.

The FLIR camera is controlled from the Video panel, and no additional icons appear on the Home page.

Refer to *"Video"* on page 104 for more information.

### BEP CZone integration

The NSS evo2 integrates with BEP's CZone system used for controlling and monitoring a distributed power system on your vessel.



The CZone icon is available in the Tools panel on the **Home** page when a CZone system is available on the network.

A separate manual is provided with your CZone system. Refer to this documentation and to the NSS evo2 Installation manual for how to install and configure the CZone system.

### CZone dashboard

When the CZone is installed and configured, an additional CZone dashboard is added to the Instruments panels.

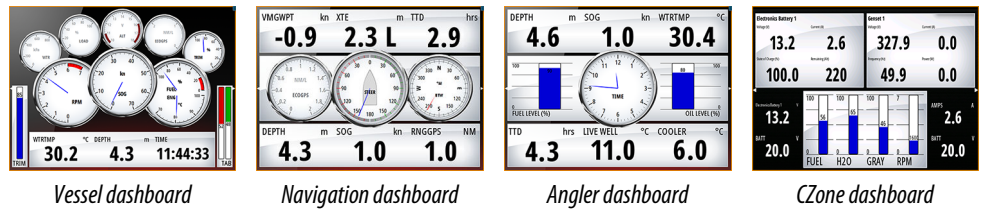

You switch between a panel's dashboards by selecting the left and right arrow symbols or by selecting the dashboard from the menu.

### Editing a CZone dashboard

You can customize a CZone dashboard by changing the data for each of the gauges. Available editing options depend on the type of gauge and which data sources that are connected to your system.

For more information, refer to "Instrument panels" on page 95.

### Remote controllers

You can connect an OP40 to the network and remotely control the NSS evo2.

A separate manual is included with the remote controller.

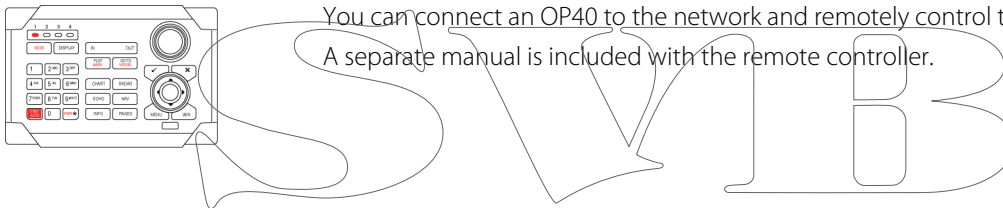

# 2

## Basic operation

### Turning the system on and off

You turn the system on and off by pressing and holding the **Power** key. You can also turn the unit off from the **System Controls** dialog.

If the **Power** key is released before the shut-down is completed, the power off process is cancelled.

→ **Note:** If the unit is configured as a slave, you cannot power off the unit by the **Power** key, and the **System Controls** dialog does not display the power off option.

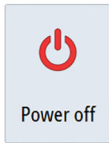

### First time startup

The first time the unit is started and after a master reset, the system runs through an automatic start-up sequence, including language setup and automatic data source selection. You can select to interrupt this sequence and later configure the system yourself.

### Standby mode

In Standby mode, the backlight for screen and keys are turned off to save power. The system continues to run in the background.

You select Standby mode from the **System Controls** dialog.

Switch from Standby mode to normal operation by a short press on the **Power** key.



### Display illumination

#### Brightness

The display backlighting can be adjusted at any time from the **System Controls** dialog. You can also cycle the preset backlight levels by short presses on the **Power** key.

If an MO monitor is plugged into the HDMI output port on a 12" or 16" unit, an additional icon will be added to the **System Controls** dialog. Select this icon to control the brightness of the external monitor.



#### Night mode

The night mode option optimizes the color palette and backlight for low light conditions.

→ **Note:** Details on the chart may be less visible when the Night mode is selected!

### Locking the touchscreen

You can temporarily lock a touchscreen to prevent accidental operation of the system. Lock the touchscreen when large amounts of water are on the screen, for example, in heavy seas and weather. This feature is also useful when cleaning the screen while the unit is turned on.

When the touch lock is active you can only operate the unit from the keys.

You lock the touchscreen from the **System Controls** dialog.



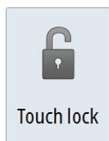



You remove the lock function by a short press on the **Power** key.



### Touchscreen operation

Basic touchscreen operation on the different panels is shown in the table below.

The panel sections in this manual have more information about panel specific touchscreen operation.

Icon	Description
	<p>Tap to:</p> <ul style="list-style-type: none"> <li>• Activate a panel on a multi-panel page</li> <li>• Position the cursor on a panel</li> <li>• Select a menu and a dialog item</li> <li>• Toggle a checkbox option on or off</li> <li>• Show basic information for a selected item</li> </ul>
	<p>Press and hold:</p> <ul style="list-style-type: none"> <li>• On any panel with a cursor to activate the cursor assist feature</li> <li>• On a panel button to see available split screen options</li> <li>• On a favorite button to enter edit mode</li> </ul>
	Scroll through a list of available options without activating any option.
	Flick to quickly scroll through e.g. the waypoint list. Tap the screen to stop the scrolling.
	Pan to position a chart or Echosounder image on the panel.
	Pinch to zoom out on the chart or on an image.
	Spread to zoom in on the chart or on an image.

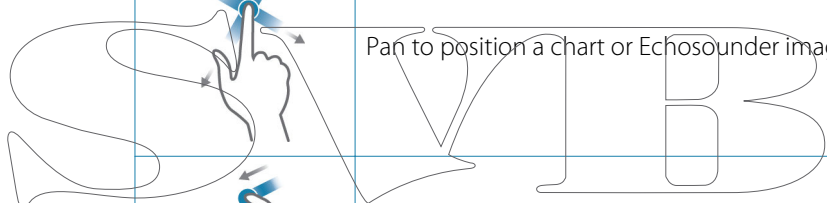

## Using menus and dialogs

### Menus

You display a page menu by selecting the **MENU** button in the upper right corner of the page.

- Activate a menu item and toggle on/off an option by selecting it
- Adjust a slide bar value by either:
  - dragging the slide bar
  - selecting the **+** or **-** icons

You can also operate the menu by using the rotary knob:

- Turn the knob to scroll through menu items
- Press the knob to select a highlighted item
- Turn the knob to adjust the value of a selected item

Select the **Back** menu option or the **X** key to return to the previous menu level, and then exit.



You can make the menu slide away by tapping the screen outside the menu area, or by pressing the **MENU** button. When you re-press the **MENU** button, the menu opens in the same status it had before it closed.

The status of the cursor (active vs. inactive) changes the menu options.

### Dialog boxes

You select entry fields and keys in a dialog box by tapping the screen or by using the rotary knob.

Numeric and alphanumeric keyboards are automatically displayed when required for entering user information in dialogs. You operate the keyboard by selecting the virtual keys, and you confirm your entry by selecting the virtual **Enter** key or by pressing the rotary knob. A dialog is closed by saving or cancelling the entry.

A dialog can also be closed by selecting the **X** in the dialog's upper right corner or by pressing the **X** key.

## Selecting pages and panels

### Selecting a page

- Select a full page panel by selecting the relevant application button on the **Home** page
- Select a favorite page by selecting the relevant favorite button
- Select a predefined split panel by pressing and holding the relevant application icon

### Select active panel

In a multiple panel page, only one panel can be active at a time. The active panel is outlined with a border.

You can only access the page menu of an active panel.

You activate a panel by tapping it.

## Creating a Man Overboard waypoint

If an emergency situation should occur, you can create a Man Overboard (MOB) waypoint at the vessel's current position by selecting the **MOB** button on the **Home** page.

When you activate the MOB function the following actions are automatically performed:

- a MOB waypoint is created at the vessel's position
  - the display switches to a zoomed chart panel, centered on the vessel's position
  - the system displays navigation information back to the MOB waypoint
- Multiple MOB waypoints are saved by repeatedly pressing the **MOB** buttons. The vessel continues to show navigation information to the initial MOB waypoint. Navigation to subsequent MOB waypoints needs to be done manually.

### Cancel navigation to MOB

The system continues to display navigational information towards the MOB waypoint until you cancel the navigation from the menu.

### Delete a MOB waypoint

1. Select the MOB waypoint to activate it
2. Tap the MOB waypoint's pop-up or press the **Enter** key or the rotary knob to display the MOB waypoint dialog
3. Select the delete option in the dialog.

A MOB waypoint can also be deleted from the menu when it is activated.

## Screen capture

Simultaneously press the **Home** and **Power** keys to take a screen capture. By default, screen captures are saved to internal memory.

Refer to "*Tools*" on page 109 for how to view files.

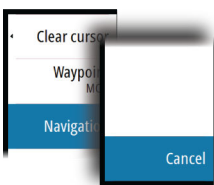

# 3

## Customizing your system

### Customizing the Home page wallpaper

The Home page's wallpaper can be customized. You can select one of the pictures included with the system, or you can use your own picture in .jpg or .png format.

The images can be available on any location that can be seen in the files browser. When a picture is chosen as the wallpaper, it is automatically copied to the Wallpaper folder.

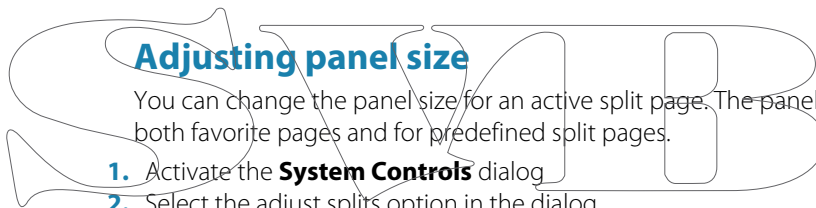
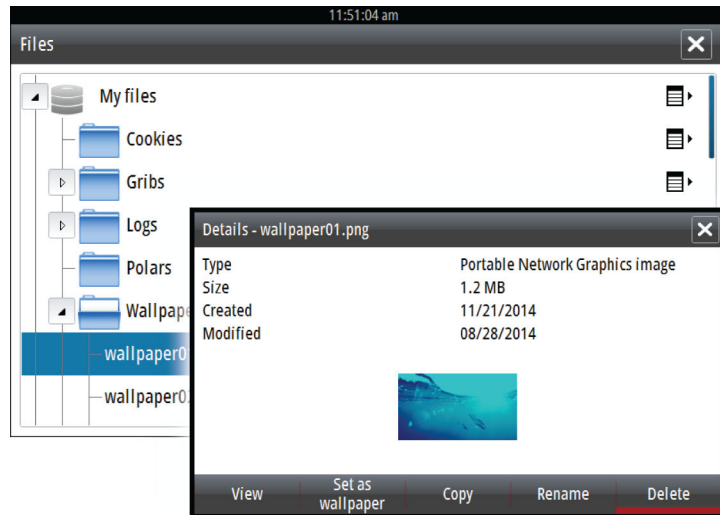

### Adjusting panel size

You can change the panel size for an active split page. The panel size can be adjusted for both favorite pages and for predefined split pages.

1. Activate the **System Controls** dialog
2. Select the adjust splits option in the dialog
3. Adjust the panel size by dragging the adjustment icon
4. Confirm your changes by tapping one of the panels, by pressing the rotary knob or the **Enter** key.

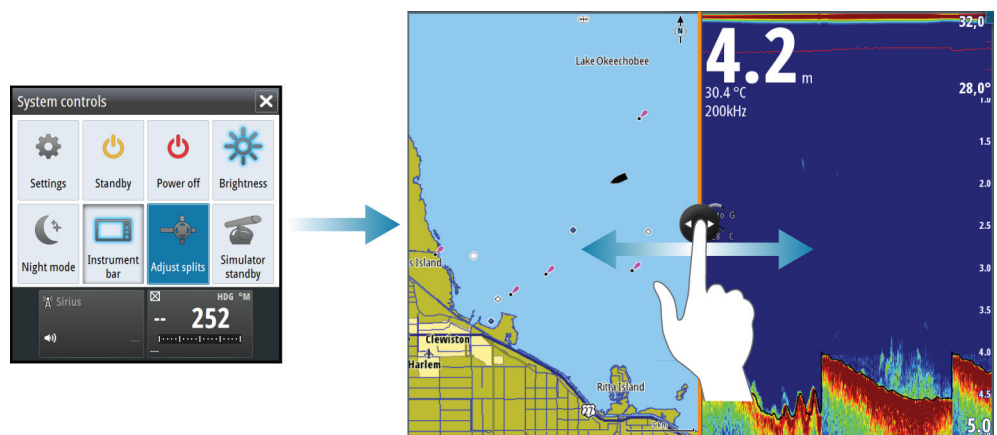

The changes are saved to the active favorite or split page.

### Password protection

You can set a PIN code to prevent unauthorized access to your system settings. When you establish password protection, the PIN code must be entered when any of the following are selected. After the correct PIN code is entered, all of them can be accessed without re-entering the PIN code.

- Settings, activated from the Tools panel or System Controls dialog
  - Alarms, activated from the Tools panel
  - Files, activated from the Tools panel
  - GoFree Shop, activated from the Tools panel
  - Settings, activated from the Chart menu under Chart Options
- You set and remove password protection from the system Settings dialog.

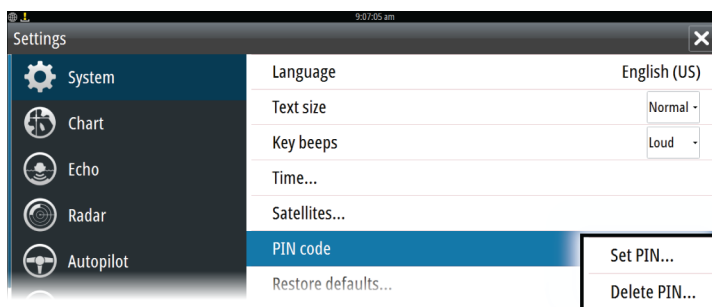

## Adding new favorite pages

1. Select the **New** icon in the favorite panel on the **Home** page to open the page editor dialog
2. Drag and drop page icons to set up a new page
3. Change the panel arrangement (only possible for 2 or 3 panels), if required.
4. Save the page layout

The system displays the new favorite page, and the new page is included in the list of favorite pages on the **Home** page.

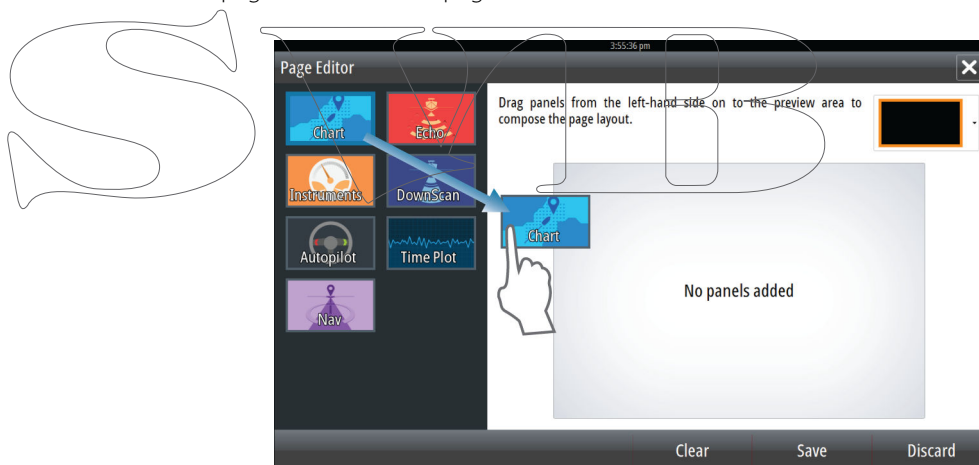

## Edit favorite pages

1. Select the edit icon in the Favorite panel:
  - Select the X icon for a favorite icon to remove the page
  - Select the tool icon for a favorite icon to display the page editor dialog
2. Add or remove panels in the page editor dialog.
3. Save or discard your changes to leave the favorite edit mode.

## Setting the appearance of the Instrument bar

Data sources connected to the system can be viewed in the Instrument bar.

You can configure the Instrument bar to display either one or two bars. If you specify to display two bars you can set it to alternate the bars automatically.

Use the menu to select a predefined activity for one or both of the bars. When an activity bar is selected, predefined instrument gauges are displayed in the instrument bar.

You can specify the information displayed in the instrument bars.

You can turn the Instrument bar off from the **System controls** dialog.

→ **Note:** This only turns the Instrument bar off for the current page.

### Turning the Instrument bar on/off

1. Activate the **System controls** dialog
2. Deactivate/activate the instrument bar icon to toggle the bar on and off.

### Select a predefined activity bar

1. Activate the Instrument bar by selecting it
2. Select the **MENU** button to open the menu
3. Select **Bar 1** or **Bar 2** and then a predefined activity bar.

Predefined gauges are displayed in instrument bar. You can change a gauge in the activity Instrument bar, refer to Edit the content of the Instrument bar.

### Edit the content of the Instrument bar

1. Activate the Instrument bar by selecting it
2. Select the **MENU** button to open the menu
3. Select **Edit** to change an instrument gauge followed by the gauge you want to change
4. Select the content you want to display from the Choose Data dialog
5. Select **Menu** and then **Finish editing** to save your changes.

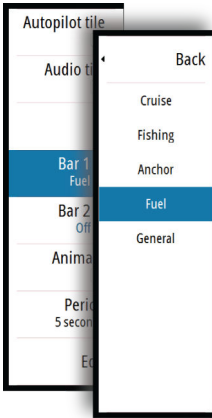

### Fuel economy gauge

You can display a fuel economy gauge in the instrument bar on application pages (Chart, Radar, Echo, Nav, and so on). Select the predefined Fuel activity bar or change a gauge source to Fuel Economy. To change a gauge source, refer to "Setting the appearance of the Instrument bar" on page 19.

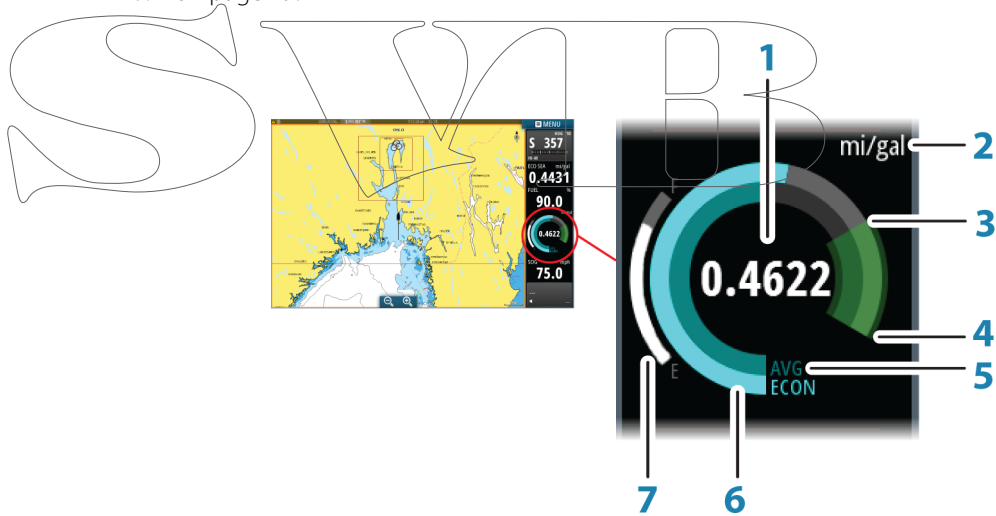

- 1 Digital readout of current economy
- 2 Fuel economy measurement units
- 3 100% efficiency, this equates to the 'nominal consumption'
- 4 120% efficiency
- 5 Average fuel economy
- 6 Instantaneous economy
- 7 Current fuel level

The fuel economy gauge displays the instantaneous versus historical average fuel efficiency. The start of the green zone represents 'Nominal Fuel Economy', and it displays an additional 20% area to allow your fuel efficiency to be displayed above the nominal fuel economy.

The more efficient you consume fuel, the more the outer blue dial creeps up towards the green portion of the scale. If you achieve the nominal efficiency of your vessel you will be at

the green zone. If you manage to achieve an efficiency better than your nominal efficiency, you will be somewhere in the upper green zone.

Nominal fuel economy can be entered in the Vessel Setup dialog displayed from the Fuel settings dialog.

You can reset your average fuel economy from the Reset Fuel Economy button on the Fuel settings dialog. When you reset it, the system starts calculating the new average.

Set the measurement units for the fuel economy gauge in the Economy field in the Units settings dialog.

## Bridge Control

The Bridge Control feature allows you to control which pages are shown on several displays at the same time. The feature is used on vessels with multiple displays mounted in the same place to quickly configure what information is displayed.

There can be a maximum of four different bridges on your system, and you can have up to four displays grouped into one bridge. Each display can be configured to only one bridge.

When the displays are included in a bridge, you can configure twelve page configurations (presets) for each bridge.

### Adding displays to a Bridge

→ **Note:** All displays must be turned on to be available for bridge configuration.

1. Open the **Bridge Configuration** dialog
2. Select to configure a new bridge or to edit an existing
  - The **Bridge Configuration** for the selected bridge will be shown, and all displays that are not already assigned to a bridge will be listed
3. Select the display you want to add to the bridge
  - Arrange the displays from left to right in the same physical layout as the displays on your current bridge/dashboard/helm
4. Rename the bridge if required
5. Save the configuration

The **Bridge Control** button will be displayed on the **Home page** of all displays that are configured for a bridge.

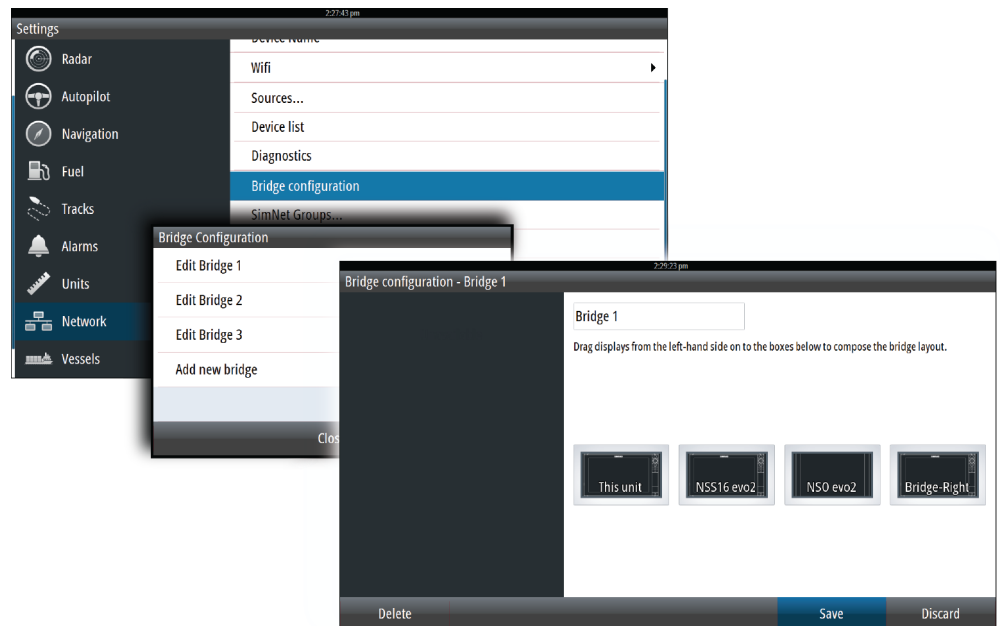

### Configuring the preset pages for displays in a bridge

1. Activate the **Bridge Control** panel by selecting the **Bridge Control** button on the **Home** page
2. Enter edit mode by selecting the edit icon

3. Select the display for which you want to define the preset page
  - The page layout option for the selected display will be read from the network, showing main features and configured favorite pages
4. Select the preferred page
  - Select the blank page if you do not want that display to be included in the selected **Bridge preset**
5. Repeat step 3 and 4 until a page is configured for all displays in all **Bridge presets**
6. Select the edit icon again to leave the edit mode and to save your configuration



### Selecting Bridge presets

You display an overview of available **Bridge presets** by selecting the **Bridge Control** button on the **Home** page.

When you select one of the preset configurations all devices included in that bridge will switch to the pre-configured pages.

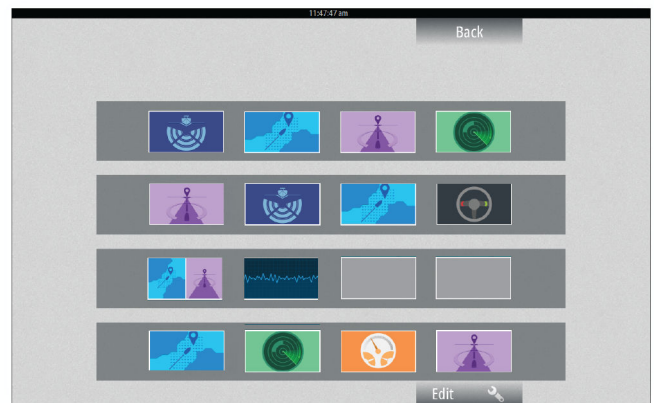
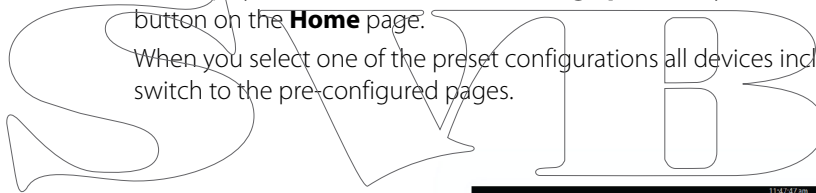

# 4

## Charts

The chart function displays your vessel's position relative to land and other chart objects. On the chart panel you can plan and navigate routes, place waypoints, and display AIS targets. You can overlay a radar image, a StructureScan image or weather information.

### The Chart panel

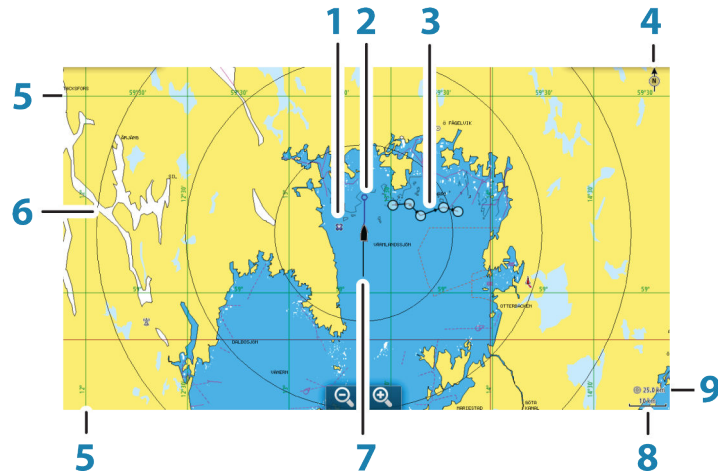

- 1 Waypoint\*
- 2 Vessel with extension line (extension line is optional)
- 3 Route\*
- 4 North indicator
- 5 Grid lines\*
- 6 Range rings\*
- 7 Track\*
- 8 Chart range scale
- 9 Range rings interval (only displayed when Range rings are turned on)

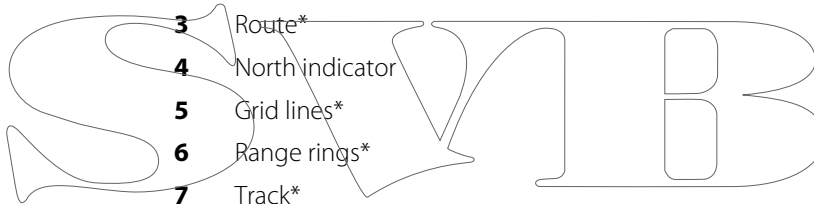

\* Optional chart items. You turn the optional images on/off individually from the Chart settings dialog.

### Chart data

The system is delivered with different embedded cartography depending on region.

All units support Insight charts from Navico including Insight Genesis. The system also supports charts from Navionics and Jeppesen as well as content created by a variety of third party mapping providers in the AT5 format. For a full selection of available charts, visit [gofreeshop.com](http://gofreeshop.com), [c-map.jeppesen.com](http://c-map.jeppesen.com), or [navionics.com](http://navionics.com).

→ **Note:** In this manual, all possible chart menu options are described. These options vary depending on the chart you are using.

Charts on chart cards are shared over the Ethernet network, so only one chart card per vessel is required.

→ **Note:** The system does not automatically switch to embedded cartography if the chart card is removed. A low-resolution chart will be displayed until you re-insert the card or manually switch back to the embedded cartography.

### Showing dual chart types

If you have different chart types available - embedded, in the card slot, or on the Ethernet network - you can show two different chart types simultaneously on a page with two chart panels.

You can select a dual chart panel by pressing and holding the Chart application button on the **Home** page, or by creating a favorite page with two chart panels.

### Selecting chart type

You specify the chart type in the Chart panel by selecting one of the available chart types in the chart source menu option. If you have a multiple Chart panel, the chart type is set individually for each chart panel. Activate one of the chart panels, and then select one of the available chart types in the chart source menu option. Repeat the process for the second chart panel, and select an alternative chart type for this panel.

If you have identical charts available - built in, in the card slot or on the Ethernet network - the system automatically selects the chart with most chart details for your displayed region.

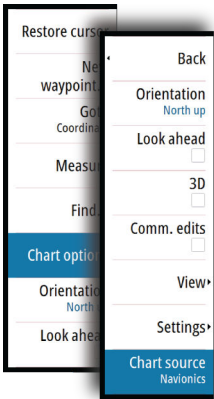

### Panning the chart

You can move the chart in any direction by dragging your finger on the screen.

Select the **Clear cursor** menu option or press the **X** key to remove the cursor and cursor window from the panel. This also centers the chart to the vessel position.

### Chart scale

You zoom in and out on the chart by using the zoom panel icons, the rotary knob, or by using 2 fingers to pinch (zoom out) and spread (zoom in).

Chart range scale and range rings interval (when turned on) are shown in the lower right corner of the chart panel.



### Vessel symbol

When the NSS evo2 has a valid GPS position lock, the vessel symbol indicates vessel position. If no GPS position is available, the vessel symbol includes a question mark.



### Positioning the vessel on the chart panel

#### Chart orientation

Several options are available for how the chart is rotated in the panel. The chart orientation symbol in the panel's upper right corner indicates the north direction.

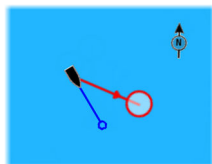

North up

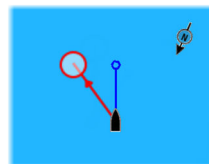

Heading up

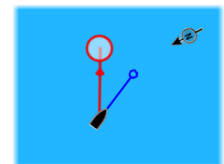

Course up

#### North up

Displays the chart with north upward.

#### Heading up

Displays the chart with the vessel's heading directed upward. Heading information is received from a compass. If heading is not available, then the COG from the GPS is used.

#### Course up

Rotates the chart in the direction of the next waypoint when navigating a route or navigating to a waypoint. If not navigating the heading up orientation is used until navigation is started.

#### Look ahead

Moves the vessel icon closer to the bottom of the screen so that you can maximize your view ahead.



## Displaying information about chart items

When you select a chart item, a waypoint, a route, or a target, basic information for the selected item is displayed. Select the chart item's pop-up to display all available information for that item. You can also activate the detailed information dialog from the menu.

- **Note:** If you are viewing applicable Jeppesen charts on your system, you can select marine objects to display information about services and available multimedia (photos) associated with the location or object.
- **Note:** Pop-up information has to be enabled in chart settings to see basic item information.

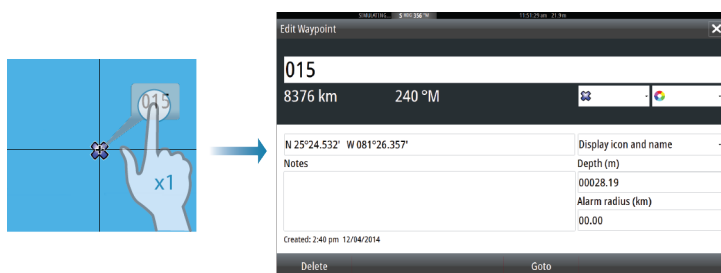

## Using the cursor on the chart panel

By default, the cursor is not shown on the chart panel.

When you activate the cursor, the cursor position window is displayed. When the cursor is active, the chart does not pan or rotate to follow the vessel.

Press the **X** key or select the **Clear cursor** menu option to remove the cursor and the cursor window from the panel. This also centers the chart to the vessel position.

Select the **Restore cursor** menu option to display the cursor in its previous location. The **Clear cursor** and **Restore cursor** options are useful features for toggling between the vessel's current location and the cursor position.

N 59°01.280'  
E 13°37.148'  
110.5 mi, 104 °M

### GoTo cursor

You can navigate to a selected position on the image by positioning the cursor on the panel, then using the **Goto Cursor** option in the menu.

### The Cursor assist function

The cursor assist function allows for fine tuning and precision placement of the cursor without covering details with your finger.

Press and hold your finger on the screen to switch the cursor symbol to a selection circle, appearing above your finger.

Without removing your finger from the screen, drag the selection circle over the desired item to display item information.

When you remove your finger from the screen the cursor reverts to normal cursor operation.

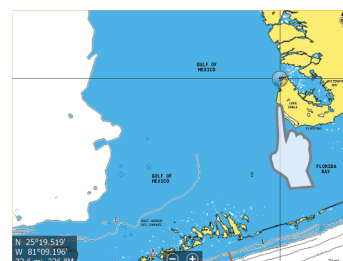
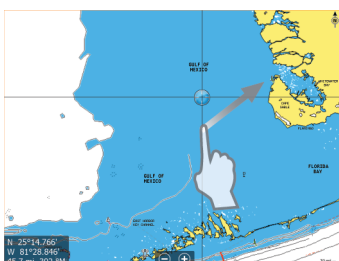

## Saving waypoints

You can save a waypoint at a selected location by positioning the cursor on the panel, and then selecting the new waypoint option in the menu.

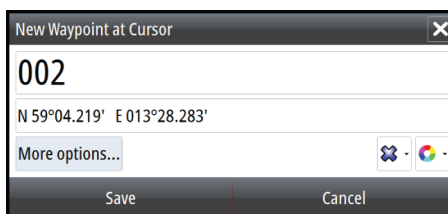

In the Chart and Nav panels, you can save a waypoint at the vessel position, when the cursor is not active, by selecting the new waypoint option in the menu.

If your unit has a **MARK** key, you can press this key to immediately save a waypoint. If the cursor is active, the waypoint is saved at the cursor position. If the cursor is not active, the waypoint is saved at your vessel's position.

## Creating routes

You can create routes as follows on the chart panel.

1. Position the cursor on the chart panel.
2. Select **New** followed by **New route** in the menu.
3. Tap the chart panel to position the first routepoint.
4. Continue positioning the remaining routepoints.
5. Save the route by selecting the save option in the menu.

→ **Note:** For more information, refer to "*Waypoints, Routes, and Tracks*" on page 40.

## Measuring distance



The cursor can be used to measure the distance between your vessel and a selected position, or between 2 points on the chart panel.

1. Position the cursor on the point from where you want to measure the distance.
2. Start the measure function from the menu.
  - The measuring icons appear with a line drawn from the vessel center to the cursor position, and the distance is listed in the cursor information window.
3. You can reposition the measuring points by dragging either icon as long as the measuring function is active.

→ **Note:** The bearing is always measured from the grey icon to the blue icon.

You can also start the measuring function without an active cursor. Both measuring icons are then initially located at the vessel position. The grey icon follows the vessel as the vessel moves, while the blue icon remains at the position given when you activated the function.

You terminate the measuring function by selecting the **Finish measuring** option or by pressing the **X** key.

## Find objects on chart panels

You can search for other vessels or various chart items from a chart panel.

Activate the cursor on the panel to search from the cursor position. If the cursor is not active, the system searches for items from the vessel's position.

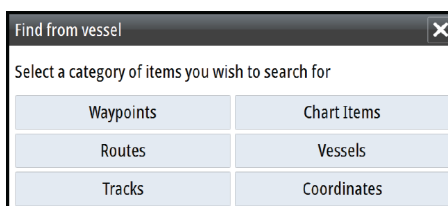

→ **Note:** You must have a SIRIUS data package subscription to search for fueling stations and an AIS receiver connected to search for vessels.

## 3D charts

The 3D option provides a three dimensional graphical view of land and sea contours.

- **Note:** All chart types work in 3D mode, but without 3D cartography for the appropriate area the chart appears flat.

When the 3D chart option is selected, the Pan and the Rotate icons appear on the chart panel.



### Panning the 3D chart

You can move the chart in any direction by selecting the Pan icon and then panning in the desired direction.

Press the **X** key or select the **Return to vessel** menu option to stop panning, and to center the chart to vessel position.



### Controlling the view angle

You can control the view angle by selecting the Rotate icon and then panning the chart panel.

- To change the direction you are viewing, pan horizontally
- To change the tilt angle of the view, pan vertically

- **Note:** When centered on the vessel position, only the tilt angle can be adjusted. The view direction is controlled by the chart orientation setting. See "*Positioning the vessel on the chart panel*" on page 24.

### Zooming a 3D chart

You zoom in and out on a 3D chart by using the zoom panel icons or the rotary knob.

## Chart overlay

Radar, Structure, and Weather information can be displayed as overlay on your chart panel. When an overlay is selected, the chart menu expands to include basic functions for the selected overlay.

Radar, Structure, and Weather functions are described in separate sections in this manual.

## Insight charts

### Insight specific chart options

Orientation, Look ahead, 3D, and change Chart source (previously described in this section) are common for all chart types.

### Chart imagery style

The charts can be displayed in three imagery styles.

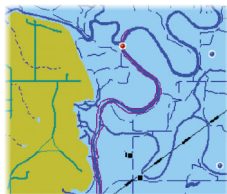
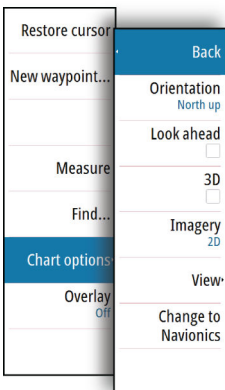

2D mapping style

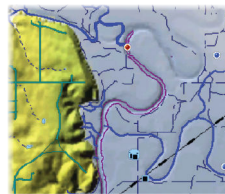

Shaded relief



No contours

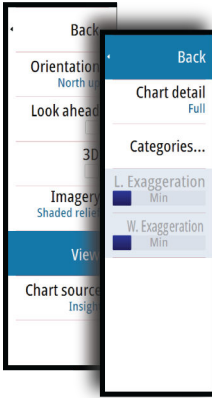

## Insight view options

### Chart detail

- **Full**  
All available information for the chart in use.
- **Medium**  
Minimum information sufficient for navigation.
- **Low**  
Basic level of information that cannot be removed, and includes information that is required in all geographic areas. It is not intended to be sufficient for safe navigation.

### Insight chart categories

Insight charts include several categories and sub-categories that you can turn on/off individually depending on which information you want to see.

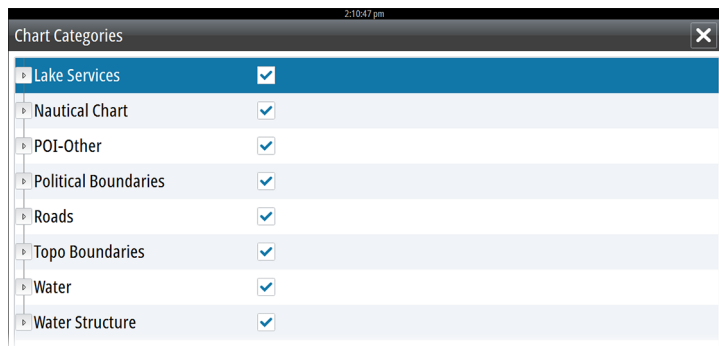

## Land Exaggeration and Water Exaggeration

Graphical settings available in 3D mode only. Exaggeration is a multiplier applied to the drawn height of hills on land, and troughs in water to make them look taller or deeper.

## Navionics charts

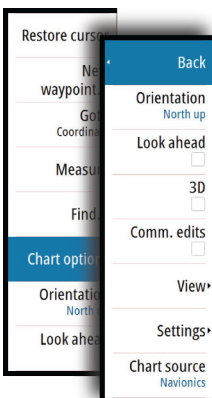

### Navionics specific chart options

Orientation, Look ahead, 3D and change Chart source (previously described in this section) are common for all chart types.

### Community edits

Toggles on the chart layer including Navionics edits. These are user information or edits uploaded to Navionics Community by users, and made available in Navionics charts.

For more information, refer to Navionics information included with your chart, or to Navionics website: [www.navionics.com](http://www.navionics.com).

### Navionics view options

#### Chart shading

Shading adds terrain information to the chart.

#### Navionics dynamic tide and current icons

Shows tides and currents with a gauge and an arrow instead of the diamond icons used for static tides and current information.

The tide and current data available in Navionics charts are related to a specific date and time. The system animates the arrows and/or gauges to show the tides and currents evolution over time.



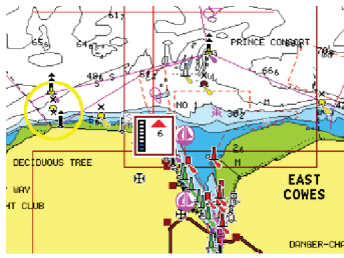

Dynamic tide information

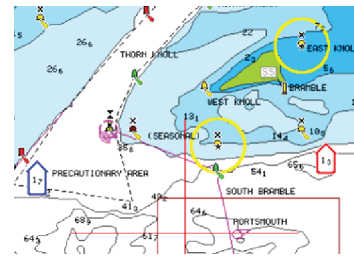

Dynamic current information

The following icons and symbology are used:



**Current speed**

The arrow length depends on the rate, and the symbol is rotated according to flow direction. Flow rate is shown inside the arrow symbol. The red symbol is used when current speed is increasing, and the blue symbol is used when current speed is decreasing.



**Tide height**

The gauge has 8 labels and is set according to absolute max/min value of the evaluated day. The red arrow is used when tide is rising, and the blue arrow is used when tide is falling.

→ **Note:** All numeric values are shown in the relevant system units (unit of measurement) set by user.

**Easy View**

Magnifying feature that increases the size of chart items and text.

→ **Note:** There is no indication on the chart showing that this feature is active.

**Photo overlay**

Photo overlay enables you to view satellite photo images of an area as an overlay on the chart. The availability of such photos is limited to certain regions, and cartography versions. You can view photo overlays in either 2D or 3D modes.

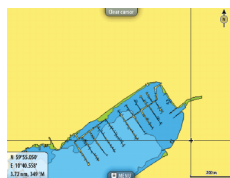

No Photo overlay

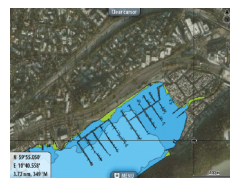
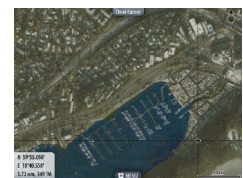

Photo overlay, land only



Full Photo overlay

**Photo transparency**

The Photo transparency sets the opaqueness of the photo overlay. With minimum transparency settings the chart details are almost hidden by the photo.

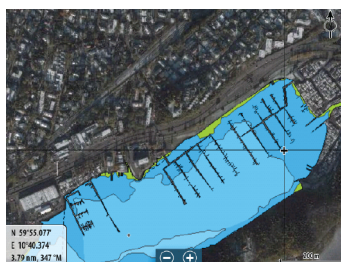

Minimum transparency



Maximum transparency

**Navionics Fish N' Chip**

The system supports Navionics Fish N' Chip (U.S. only) chart feature. For more information, see [www.navionics.com](http://www.navionics.com).

## Depth highlight range

Select a range of depths between which Navionics fills with a different color.

This allows you to highlight a specific range of depths for fishing purposes. The range is only as accurate as the underlying chart data, meaning that if the chart only contains 5 meter intervals for contour lines, the shading is rounded to the nearest available contour line.

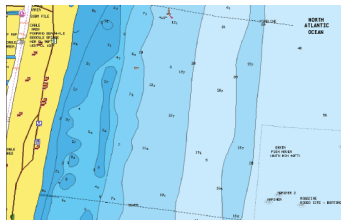

No Depth highlight range

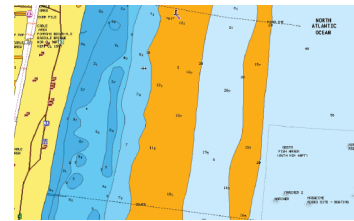

Depth highlight range: 6 m - 12 m

## Shallow water highlight

Highlights areas of shallow water.

This allows you to highlight areas of water between 0 and the selected depth (up to 10 meters/30 feet).

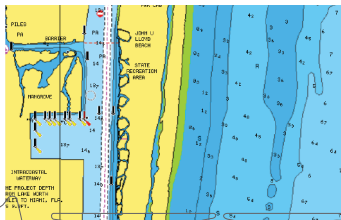

No shallow water highlighted

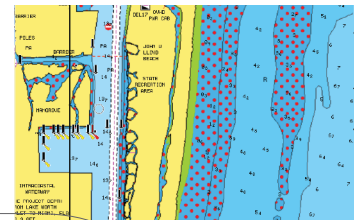

Shallow water highlight: 0 m - 3 m

## Navionics chart settings

### Colored seabed areas

Used for displaying different depth areas in different shades of blue.

### Presentation type

Provides marine charting information such as symbols, colors of the navigation chart and wording for either International or U.S. presentation types.

### Annotation

Determines what area information, such as names of locations and notes of areas, is available to display.

### Chart details

Provides you with different levels of geographical layer information.

### Safety depth

The Navionics charts use different shades of blue to distinguish between shallow and deep water.

Safety depth, based on a selected limit, is drawn without blue shading.

→ **Note:** The built in Navionics database features data down to 20 m, after which it is all white.

### Contours depth

Determines which contours you see on the chart down to the selected safety depth value.

### Rock filter level

Hides rock identification on the chart beneath a given depth.

This helps you to declutter charts in areas where there are many rocks located at depths well below your vessel's draught.

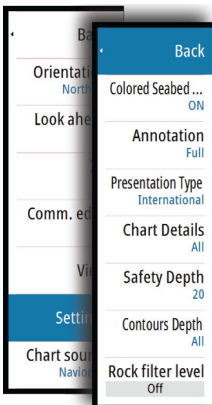

## Jeppesen charts

All possible menu options for Jeppesen charts are described below. The Jeppesen features and menu options can vary depending on the Jeppesen charts you use.

### Jeppesen tides and currents

The system can display Jeppesen tides and currents. With this information it is possible to predict the time, level, direction and strength of currents and tides. This is an important tool when considering planning and navigation of a trip.

In large zoom ranges the tides and currents are displayed as a square icon including the letter **T** (Tides) or **C** (Current). When you select one of the icons, tidal or current information for that location are displayed.

Dynamic current data can be viewed by zooming inside a 1-nautical mile zoom range. At that range, the Current icon changes to an animated dynamic icon that shows the speed and direction of the current. Dynamic icons are colored in black (greater than 6 knots), red (greater than 2 knots and less than or equal to 6 knots), yellow (greater than 1 knot and less than or equal to 2 knots) or green (equal to or less than 1 knot), depending on the current in that location.

If there is no current (0 knots) this will be shown as a white, square icon.

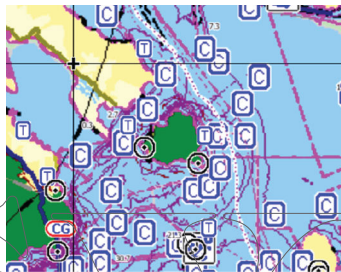

Static Current and Tide icons

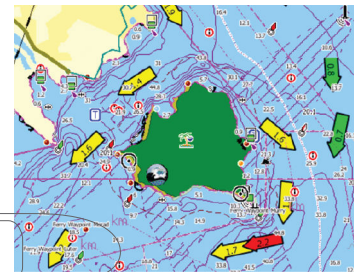

Dynamic Current icons

### Jeppesen specific chart options

Orientation, Look ahead, 3D, and change Chart source (previously described in this section) are common for all chart types.

### Presentation

The charts can be displayed in different imagery styles.

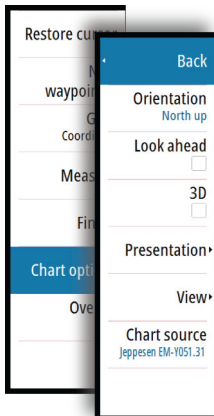

Shaded relief

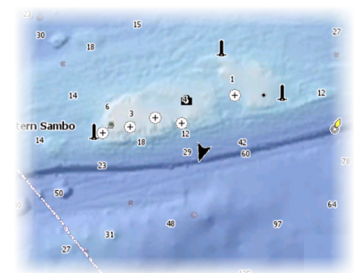

No contours

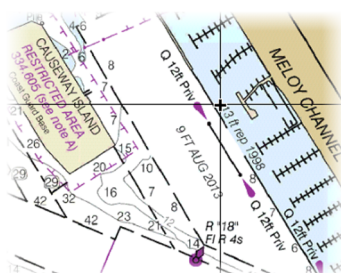

Raster imagery

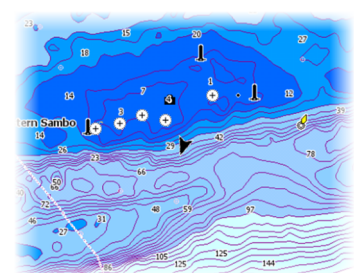

High resolution bathymetry

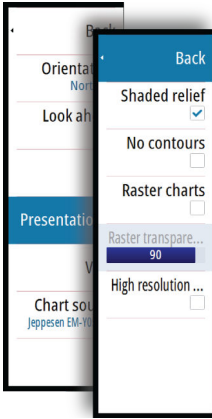

### Shaded relief

Shades seabed terrain.

### No contours

Removes contour lines from the chart.

### Raster charts

Changes the view to that of a traditional paper chart.

### Raster transparency

Controls the transparency of raster imagery.

### High resolution bathymetry

Enables and disables higher concentration of contour lines.

## Jeppesen view options

### Chart detail

- **Full**  
All available information for the chart in use.
- **Medium**  
Minimum information sufficient for navigation.
- **Low**  
Basic level of information that cannot be removed, and includes information that is required in all geographic areas. It is not intended to be sufficient for safe navigation.

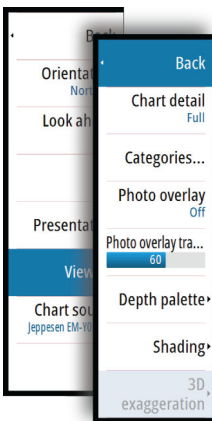

### Jeppesen chart categories

Jeppesen charts include several categories and sub-categories that you can turn on/off individually depending on which information you want to see.

### Photo overlay

Photo overlay enables you to view satellite photo images of an area as an overlay on the chart. The availability of such photos is limited to certain regions, and cartography versions. You can view photo overlays in either 2D or 3D modes.

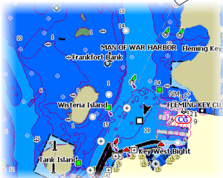

No Photo overlay



Photo overlay, land only



Full Photo overlay

### Photo transparency

The Photo transparency sets the opaqueness of the photo overlay. With minimum transparency settings the chart details are almost hidden by the photo.



Minimum transparency



Transparency at 80



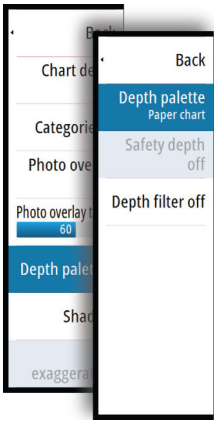

### Depth palette

Controls the Depth palette used on the map.

### Paper chart

Changes the appearance of the map to a paper chart style.

### Safety depth

Jeppesen charts use different shades of blue to distinguish between shallow (lighter shades) and deep (darker shades) water. After enabling Safety depth, specify the desired safety depth limit. The Safety depth sets the limit at which depths will be drawn without blue shading.

### Depth filter

Filters out depth values shallower than the selected depth filter limit.

### Shading

Shades different areas of the seabed, depending on the selected Shading category.

→ **Note:** Composition and Vegetation shading are not applicable to Jeppesen charts.

### Depth 1 and Depth 2

Depth presets that shade different depths in different colors.

### Custom

You can adjust the depth threshold, color and opacity (transparency) of color shading for Depth 1 and Depth 2.

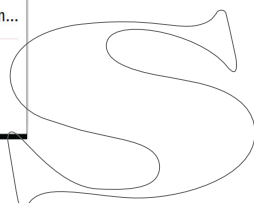
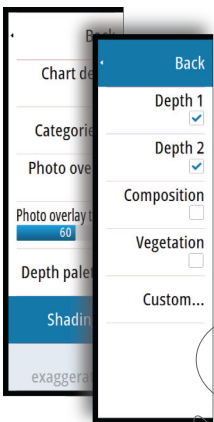

SIMULATING... S HDG 007 °M 8:02:16 am 21.3 m				
Custom Shading				
	Depth 1	Depth 2	Composition	Vegetation
Depth (m)	Color		Opacity (%)	
0	[Dark Blue]		100	
10	[Light Blue]		40	
24	[Dark Blue]		100	
37	[Dark Blue]		100	
49	[Dark Blue]		100	
Add Point...				

### 3D exaggeration

Graphical settings that are available in 3D mode only. Exaggeration is a multiplier applied to the drawn height of hills on land, and troughs in water to make them look taller or deeper.

→ **Note:** This option is grayed out if the data is not available in the map card inserted.

## Chart settings

Settings and display options made in the Chart settings page are common for all chart panels.

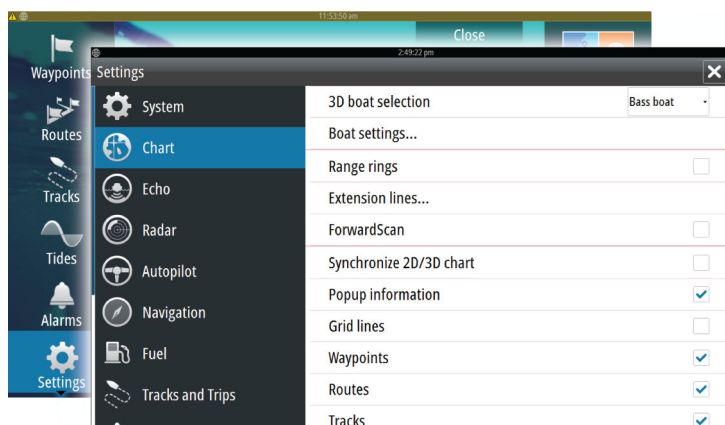

### 3D boat selection

Determines which icon to use on 3D charts.

### Boat settings

The boat settings are used when calculating an automatic route. The boat's draught, width and height must be input to use the autorouting and easy routing features.

### Range Rings

The range rings can be used to present the distance from your vessel to other chart objects. The range scale is set automatically by the system to suit the chart scale.

### Extension lines

Sets the lengths of the extension lines for your vessel and for other vessels shown as AIS targets.

**A:** Heading

**B:** Course Over Ground (COG)

The lengths of the extension lines are either set as a fixed distance, or to indicate the distance the vessel moves in the selected time period. If no options are turned on for the vessel then no extension lines are shown for your vessel.

Your vessel heading is based on information from the active heading sensor and the COG is based on information from the active GPS sensor.

For other vessels, COG data is included in the message received from the AIS system.

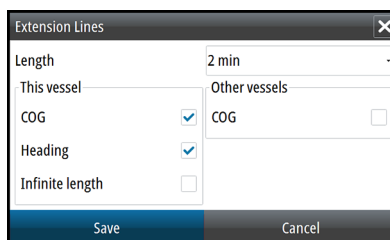
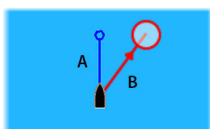

### ForwardScan

If you have ForwardScan and this option is selected, the ForwardScan heading extension is shown on the chart. Refer to "*Heading extension*" on page 84.

### **Synchronize 2D/3D chart**

Links the position shown on one chart with the position shown on the other chart when a 2D and a 3D chart are shown side by side.

### **Pop-up information**

Selects whether basic information for chart items is displayed when you select the item.

### **Grid lines**

Turns on/off viewing of longitude and latitude grid lines on the chart.

### **Waypoints, Routes, Tracks**

Turns on/off displaying of these items on chart panels. Also opens the Waypoints, Routes and Tracks dialogs you can use to manage them.

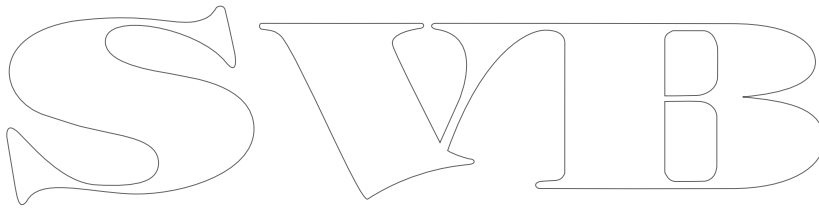

# 5

## Waypoints, Routes, and Tracks

### Waypoints

A waypoint is a user generated mark positioned on a chart, on a radar image or on the Echosounder image. Each waypoint has an exact position with latitude and longitude coordinates. A waypoint positioned on the Echosounder image has a depth value, in addition to position information. A waypoint is used to mark a position you later may want to return to. Two or more waypoints can also be combined to create a route.

### Saving waypoints

You can save a waypoint at a selected location by positioning the cursor on the panel, and then selecting the new waypoint option in the menu.

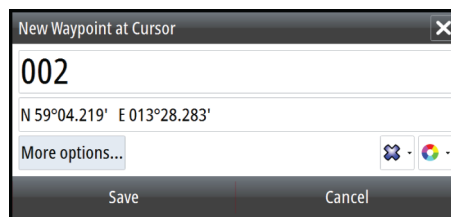

In the Chart and Nav panels, you can save a waypoint at the vessel position, when the cursor is not active, by selecting the new waypoint option in the menu.

If your unit has a **MARK** key, you can press this key to immediately save a waypoint. If the cursor is active, the waypoint is saved at the cursor position. If the cursor is not active, the waypoint is saved at your vessel's position.

### Moving a waypoint

1. Select the waypoint you want to move
  - The waypoint icon expands to indicate that it is active
2. Activate the menu and select the waypoint in the menu
3. Select the move option
4. Select the new waypoint position
5. Press the **Enter** key or the rotary knob to confirm the new position.

The waypoint is now automatically saved at the new position.

### Edit a waypoint

You can edit all information about a waypoint from the **Edit Waypoint** dialog.

This dialog is activated by selecting the waypoint's pop-up, by pressing the rotary knob, or from the menu when the waypoint is activated.

The dialog can also be accessed from the Waypoints tool on the **Home** page.

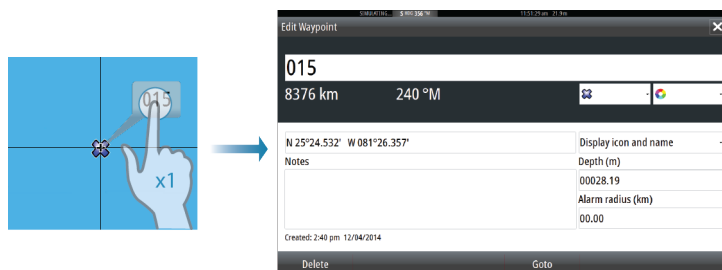

### Waypoint alarm settings

You can set an alarm radius for each individual waypoint you create. The alarm is set in the **Edit Waypoint** dialog.

- **Note:** The waypoint radius alarm must be toggled ON in the alarm dialog to activate an alarm when your vessel comes within the defined radius. For more information, refer to "Alarms dialog" on page 108.

## Routes

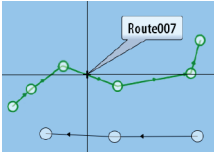

A route consists of a series of routepoints entered in the order that you want to navigate them.

When you select a route on the chart panel it turns green, and the route name is displayed.

The NSS evo2 software version 3.0 includes support for Navionics Autorouting and Jeppesen Easy Routing. This feature automatically suggest routepoints between the first and last routepoint of a route, or between selected routepoints in a complex route. You can use the feature when you create a new route, or you can use it to edit already saved routes.

### Creating a new route on the chart panel

1. Activate the cursor on the chart panel.
2. Select the new route option from the menu.
3. Position the first waypoint on the chart panel.
4. Continue positioning new routepoints on the chart panel until the route is completed.
5. Save the route by selecting the save option in the menu.

### Edit a route from the chart panel

1. Select the route to make it active.
2. Select the route edit option in the menu.
3. Position the new routepoint on the chart panel:
  - If you set the new routepoint on a leg, a new point is added between existing routepoints.
  - If you set the new routepoint outside the route, the new routepoint is added after the last point in the route.
4. Drag a routepoint to move it to a new position.
5. Save the route by selecting the save option in the menu.

- **Note:** The menu changes depending on the selected edit option. All edits are confirmed or cancelled from the menu.

### Autorouting and Easy Routing

The Autorouting and Easy Routing suggest new routepoint positions based on information in the map and on your boat's size. Before you can start using this feature the boat draught, width and height must be entered into the system. The boat settings dialog is automatically displayed if the information is missing when you start the feature.

- **Note:** NSS evo2 units designed for sale in the U.S. region do not have Autorouting or Easy Routing capabilities. Autorouting or Easy Routing features are disabled on all non-U.S. units when they are used in U.S. territorial waters.
- **Note:** It is not possible to start the Autorouting or Easy Routing if one of the selected routepoints is located in an unsafe area. A warning dialog is displayed, and you have to move the relevant routepoint(s) to a safe area to proceed.
- **Note:** If no compatible cartography is available, the Autorouting or Easy Routing menu option is not available. Compatible cartography includes Jeppesen CMAP MAX-N+, Navionics + and Navionics Platinum. For a full selection of available charts please visit [insightstore.navico.com](http://insightstore.navico.com), [c-map.jeppesen.com](http://c-map.jeppesen.com) or [navionics.com](http://navionics.com).

1. Position at least two routepoints on a new route, or open an existing route for editing.
2. Select **Autorouting**, followed by:
  - **Entire Route** if you want the system to add new routepoints between the first and the last routepoint of the open route.
  - **Selection** if you want to manually select the routepoints that define the limits for the autorouting, then select the relevant routepoints. Selected routepoints are colored red. Only two routepoints can be selected, and the system discards any routepoints between your selected start and end points.

3. Select **Accept** to start the automatic routing.
  - When the automatic routing is completed the route appears in preview mode, and the legs are color coded to indicate safe or unsafe areas. Navionics uses red (unsafe) and green (safe), while C-MAP uses red (unsafe), yellow (dangerous) and green (safe).
4. Move any routepoints if required when the route is in preview mode.
5. Select **Keep** to accept the routepoints positions.
6. Eventually repeat step 2 (**Selection**) and step 3 if you want the system to automatically position routepoints for other parts of the route.
7. Select **Save** to complete the automatic routing and save the route.

### Autorouting and Easy Routing examples

- **Entire route** option used when first and last route points are selected.



First and last routepoint



Result after automatic routing

- **Selection** option used for autorouting part of a route.



Two routepoints selected



Result after automatic routing

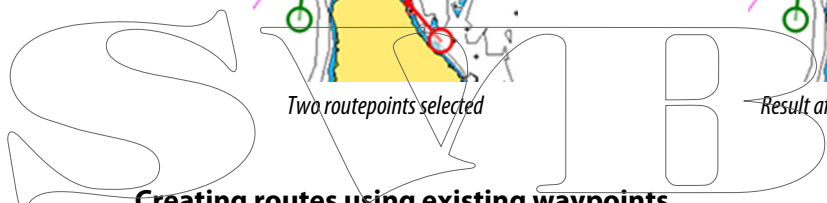

### Creating routes using existing waypoints

You can create a new route by combining existing waypoints from the **Routes** dialog. The dialog is activated by using the **Routes** tool on the **Home** page.

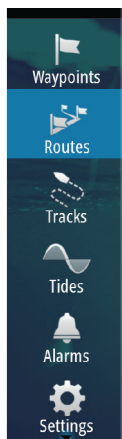

### Converting Tracks to Routes

You can convert a track to a route from the Edit Track dialog. The dialog is activated by activating the track, then selecting the track's pop-up, pressing the rotary knob or selecting the info options from the menu.

The Edit Tracks dialog can also be accessed by selecting the Tracks tool on the **Home** page.

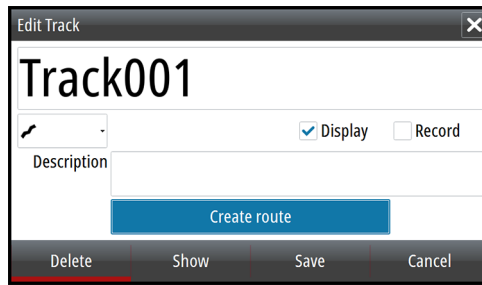

### The Edit Route dialog

You can add and remove routepoints from the **Edit Route** dialog. This dialog is activated by selecting an active route's pop-up, by pressing the rotary knob, or from the menu. The dialog can also be accessed by using the **Routes** tool on the **Home** page.

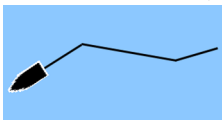
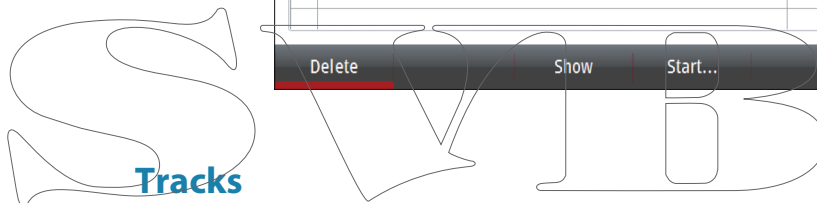

### Tracks

Tracks are a graphical presentation of the historical path of the vessel, allowing you to retrace where you have travelled. Tracks can be converted to routes from the **Edit** dialog. From the factory, the system is set to automatically track and draw the vessel's movement on the chart panel. The system continues to record the Tracks until the length reaches the maximum points, and then automatically begins overwriting the oldest points. The automatic tracking function can be turned off from the Tracks dialog.

### Creating new Tracks

You can start a new track from the **Tracks** dialog, activated by using the **Tracks** tool on the Home page.

### Tracks settings

Tracks are made up of a series of points connected by line segments whose length depends on the frequency of the recording.

You can select to position track points based on time settings, distance, or by letting the system position a waypoint automatically when a course change is registered.

→ **Note:** The Tracks option must also be turned ON in the chart settings to be visible.

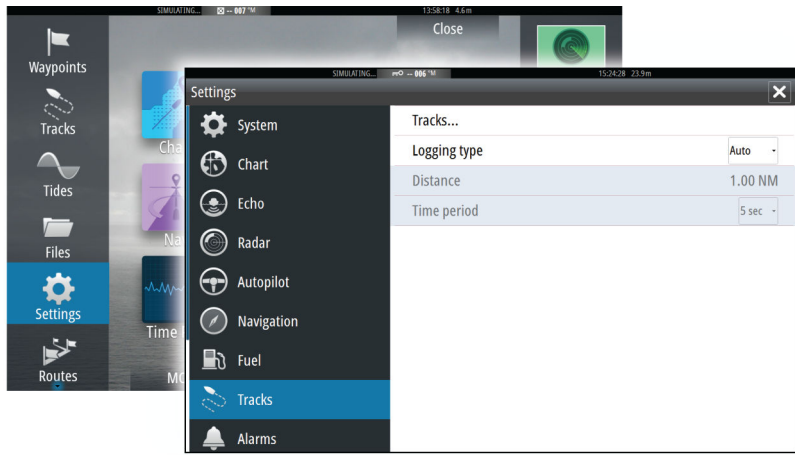

## Waypoints, Routes, and Tracks dialogs

The Waypoints, Routes, and Tracks dialogs give access to advanced edit functions and settings for these items.

The dialogs are accessed from the **Tools panel** on the **Home** page.

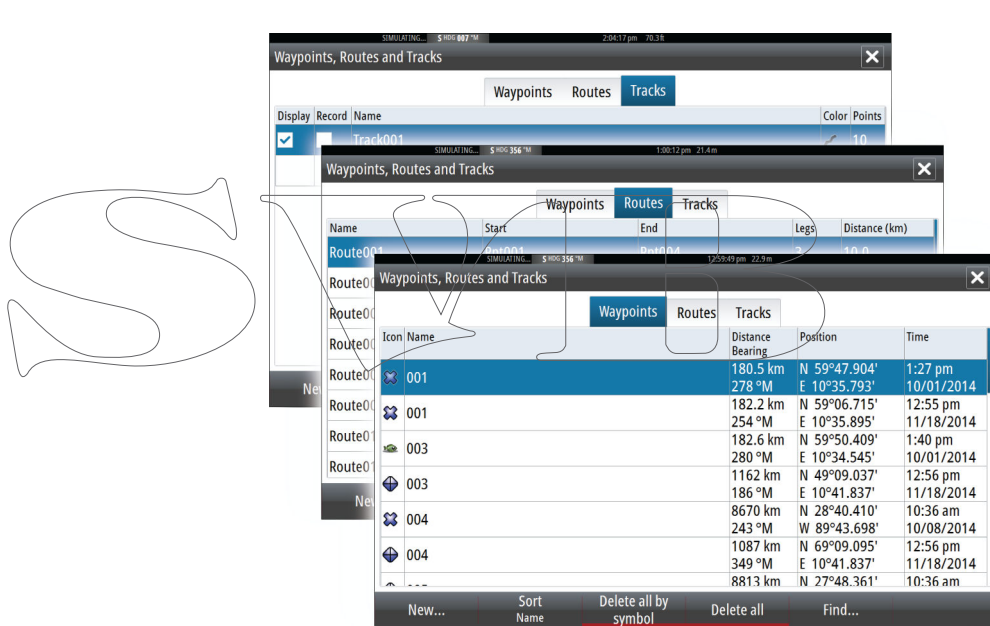



# 6

## Navigating

The navigation function included in the system allows you to navigate to the cursor position, to a waypoint, or along a predefined route.

If autopilot functionality is included in your system, the autopilot can be set to automatically navigate the vessel.

For information about positioning waypoints and creating routes, refer to "*Waypoints, Routes, and Tracks*" on page 36.

### Navigation panels

The Nav and Position panels can be used to display information when you are navigating.

#### The Nav panel

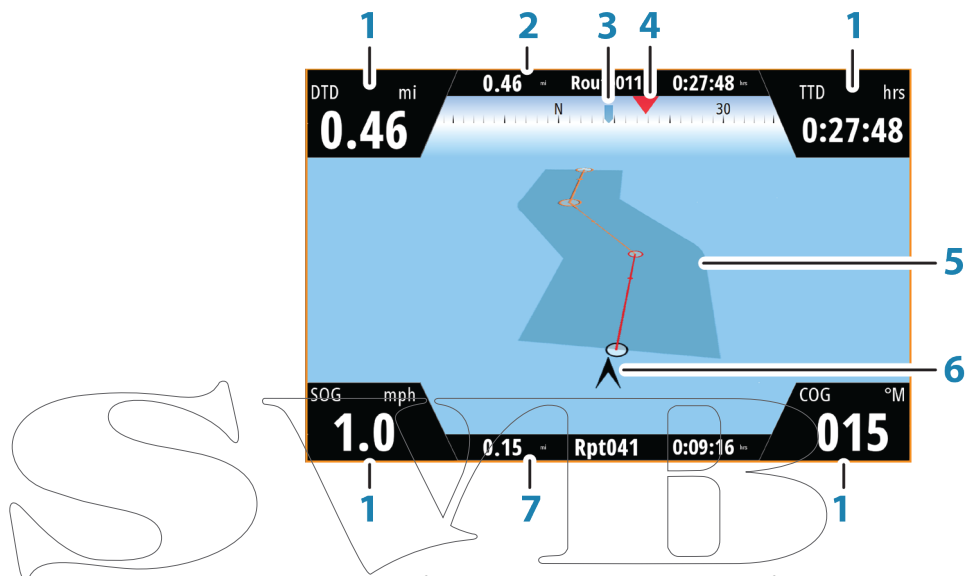

The Nav panel is activated from the Home page, either as a full page panel or as part of a multiple panel page.

- 1 Data fields**
- 2 Route information**
- 3 Vessel heading**
- 4 Bearing to next routepoint**
- 5 Bearing line with allowed off course limit**  
When travelling on a route the bearing line shows the intended course from one waypoint towards the next. When navigating towards a waypoint (cursor position, MOB or an entered lat/lon position), the bearing line shows the intended course from the point at which navigation was started towards the waypoint.
- 6 Vessel symbol**  
Indicates distance and bearing relative to the intended course. If the XTE (Cross Track Error) exceeds the defined XTE limit, this is indicated with a red arrow including the distance from the track line. Refer to "*XTE limit*" on page 44.
- 7 Routepoint information**

#### Position panels

You can switch between displaying the Nav panel or the Position panel . The Position panel is activated from the menu.

By default, there is one position panel available showing GPS position.

If Loran is enabled, there are two position panels. This is indicated with arrow symbols on left and right side of the panel.

You toggle between the panels by selecting the left or right arrow symbols, or by using the arrow keys.

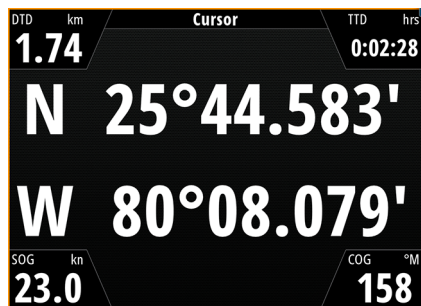

GPS position info

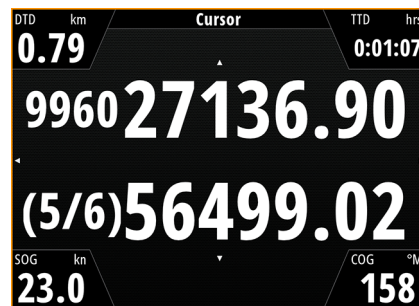

Loran position info

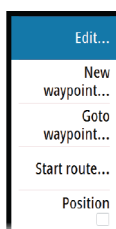

### Edit data fields

To change the data fields displayed on the Navigation panels:

1. Activate the menu.
2. Select the edit option from the menu.
3. Activate the field you want to edit.
4. Select the information type.
5. Save your changes.

### Navigate to cursor position

You can start navigating to a cursor position on any chart, radar, or Echosounder panel.

Position the cursor at the selected destination on the panel, and then select the **Goto Cursor** option in the menu.

→ **Note:** The **Goto Cursor** menu option is not available if you are already navigating.

### Navigate a route

You can start navigating a route from the chart panel or from the **Route** dialog.

When route navigation is started, the menu expands and shows options for canceling the navigation, for skipping a waypoint, and for restarting the route from current vessel position.

#### Starting a route from the chart panel

Activate a route on the panel, and then select the route navigation option from the menu.

You can select a routepoint to start navigating from a selected position.

#### Start navigating a route from the Route dialog

You can start navigating from the **Route** dialog, activated by:

- Selecting the **Route** tool from the **Home** page
- Selecting the route details from the menu

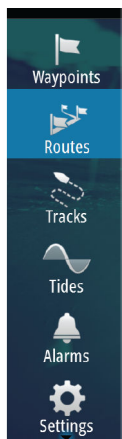

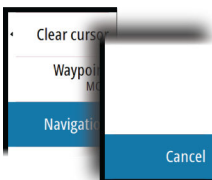
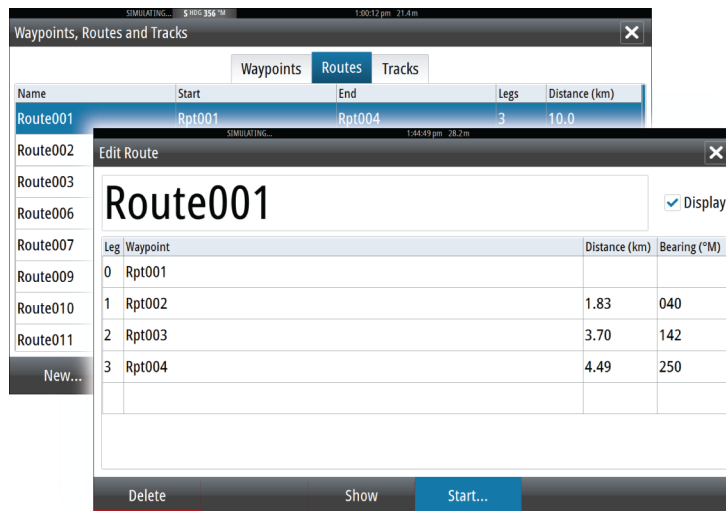

### Cancel navigation

When you are navigating, the menu includes an option for cancelling the navigation.

### Navigating with the autopilot

When you start navigation on a system with autopilot functionality, you are prompted to set the autopilot to navigation mode.

If you choose not to engage the autopilot, the autopilot can be set to navigation mode from the pilot menu later on.

For more information about autopilot functionality, refer to **"Autopilot"** on page 45.

### Navigation settings

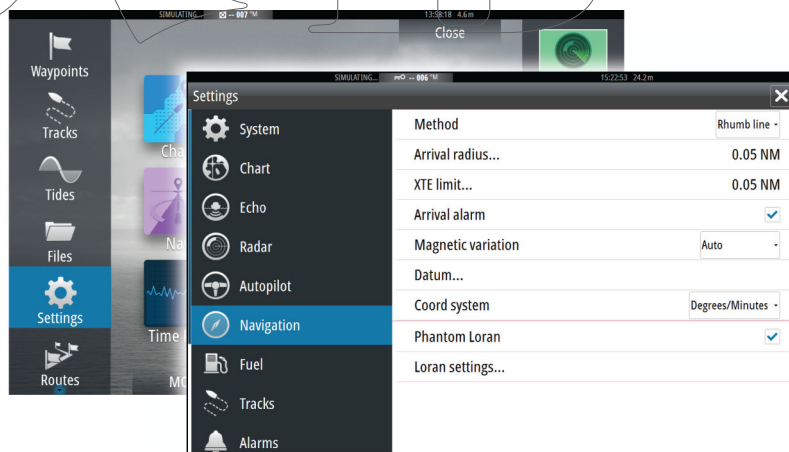

### Navigation method

Different methods are available for calculating the distance and bearing between any two points on a chart.

The Great circle route is the shortest path between two points. However, if you are to travel along such a route, it would be difficult to steer manually as the heading would constantly be changing (except in the case of due north, south, or along the equator).

Rhumb lines are tracks of constant bearing. It is possible to travel between two locations using Rhumb line computation, but the distance would usually be greater than if Great circle is used.

### Arrival radius

Sets an invisible circle around the destination waypoint.  
The vessel is considered arrived at the waypoint when it is within this radius.

### XTE limit

This setting defines how far the vessel can deviate from the selected route, if the vessel goes beyond this limit, an alarm is activated.

### Arrival alarm

When the arrival alarm is enabled, an alarm is activated when the vessel reaches the waypoint or when it is within the specified arrival radius.

### Magnetic variation

Magnetic variation is the difference between true bearings and magnetic bearings, caused by different locations of the Geographic and the Magnetic north poles. Any local anomalies such as iron deposits might also affect the magnetic bearings.

When set to Auto, the system automatically converts magnetic north to true north. Select manual mode if you need to enter your own local magnetic variation.

### Datum

Most paper charts are made in the WGS84 format, which also is used by the NSS evo2.  
If your paper charts are in a different format, you can change the datum settings accordingly to match your paper charts.

### Coordinate system

Several coordinate systems can be used to control the format for latitude and longitude coordinates displayed on the chart panel.

### Phantom Loran

Enables use of Phantom Loran positioning system.

### Loran settings

Defines Loran chains (GRI) and preferred station for waypoint entry, cursor position and position panel.

The graphic example shows a cursor position window with Loran position information.  
For more information refer to your Loran system documentation.

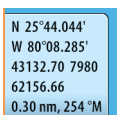

# 7

## Autopilot

If an AC12N, AC42N, SG05 or a NAC-1 autopilot computer is connected to the system, autopilot functionality is available in the system.

The system does not allow for more than one autopilot computer on the network.

The NSS evo2 automatically detects the autopilot computer available on the network and presents settings, configuration and user options for the connected computer.

An Autopilot is designed to maintain an accurate course in various sea conditions with minimal helm movements.

### Safe operation with the autopilot

**Warning:** An autopilot is a useful navigational aid, but DOES NOT replace a human navigator.

### Activating the autopilot

You activate the autopilot from any panel by pressing the **STBY/AUTO** key, followed by selecting a mode in the **Autopilot Controller**.



### Switching from automatic mode to manual steering

You switch the autopilot to STBY mode from any automatic operation mode by a short press on the **STBY/AUTO** key.

→ **Note:** If the NSS evo2 is connected to an EVC system via the SG05, you can take manual control of the steering regardless of the autopilot mode. Refer to "Using the autopilot in an EVC system" on page 53.

### Autopilot indication on the pages

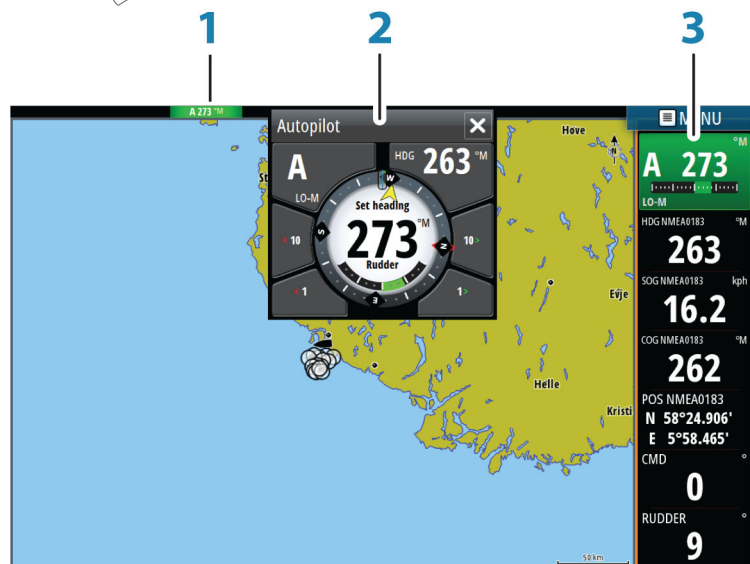

- 1 Autopilot indication in Status bar
- 2 Autopilot pop-up
- 3 Autopilot tile in Instrument bar

### Autopilot mode indication in the Status bar

The Status bar shows autopilot information as long as an autopilot computer is connected to the network.

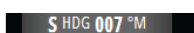

Icons are included if the autopilot is passive or locked by another autopilot control unit.

## Autopilot pop up

You control the autopilot from the autopilot pop-up.

The pop-up has a fixed position on the page, and it is available for all pages except when an Autopilot panel is active.

As long as the autopilot pop-up is active, you cannot operate the background panel or its menu.

You remove the pop-up from a page by selecting the **X** in the upper right corner, or by pressing the **X** key. You turn it on again by pressing and holding the **STBY/AUTO** key, or by selecting the autopilot tile in the instrument bar.

The following pop-ups are available:

- **Autopilot controller**, showing active mode, heading, rudder and various steering information depending on active autopilot mode. Manual adjustments to the set heading can only be made when the port and starboard arrow indicators are illuminated red and green.
- **Mode selection**, includes access to turn pattern selection.
- **Turn pattern selection**

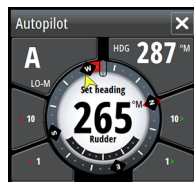

Autopilot controller



Mode selection



Turn pattern selection

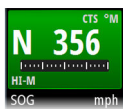

## Autopilot tile in Instrument bar

You can select to show the autopilot tile in the Instrument bar.

If the autopilot pop-up is turned off you can turn it on by selecting the tile in the Instrument bar.

## The Autopilot panel

The autopilot panel is used to display navigation data. It can be shown as a full screen panel, or in a multi-panel page.

The number of data fields included in the autopilot panel is dependent on available panel size.

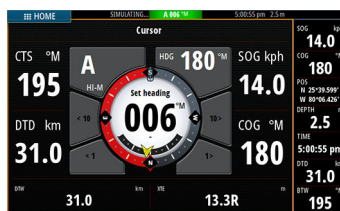

### Data fields

The following abbreviations are used in the autopilot panel:

CTS	Course to steer
DTD	Distance to destination
DTW	Distance to next waypoint
SOG	Speed over ground
COG	Course over ground
XTE	Cross track error (L: left or R: right)

## Mode overview

The autopilot has several steering modes. The number of modes and features within the mode depend on boat type and available inputs, as shown in the following list:

- **Standby**  
Standby mode used when manually steering at the helm. Compass and rudder angle is shown on the display.
- **NFU**  
Non-Follow Up steering where the rudder movement is controlled by using the Port and Starboard keys in the Pilot pop-up, or by another NFU unit.
- **FU**  
Follow-up steering where the rudder angle is set by the rotary knob or by another FU unit.
- **AUTO**  
Automatic steering where the set heading is maintained.
  - **Heading capture**  
Aborts the turn and uses the instantaneous compass reading as set heading.
  - **Turn patterns**  
Moves the vessel automatically in pre-defined turn steering patterns.
  - **Tacking**  
Only available if the boat type is set to Sail in the Autopilot Commissioning dialog, and not available for NAC-1 autopilot computers.  
Tacking with a fixed angle.
  - **NoDrift**  
Automatic steering, keeping the vessel on a straight bearing line by compensating for drift.
    - **Dodging**  
Returns to NoDrift mode after a heading change.
  - **NAV**  
Navigation steering. Steers the vessel to a specific waypoint or through a route.
  - **WIND**  
Only available if the boat type is set to Sail in the Autopilot Commissioning dialog, and not available for NAC-1 autopilot computers.  
Automatic steering where the vessel heading is changed to maintain a set wind angle.
    - **Tacking/Gybing**  
Only available if the boat type is set to Sail in the Autopilot Commissioning dialog, and not available for NAC-1 autopilot computers.  
Tacking/Gybing with apparent or true wing angle as reference.
  - **WIND Nav**  
Only available if the boat type is set to Sail in the Autopilot Commissioning dialog, and not available for NAC-1 autopilot computers.  
Automatic steering, using both wind and GPS data to steer the vessel to a specific waypoint or through a route.

## Standby mode

Standby (STBY) mode is used when you steer the boat at the helm.

- Switch the autopilot to STBY mode from any operation by a short press on the **STBY/AUTO** key.

## Non-Follow Up (NFU, Power steering)

In NFU mode you use the port and starboard arrow buttons in the autopilot pop-up to control the rudder. The rudder will move as long as the button is pressed.

- Activate NFU mode by selecting the port or starboard arrow button in the pop-up when the autopilot is in STBY or FU mode.  
You return to STBY mode by a short press on the **STBY/AUTO** key.

## Follow-up steering (FU)

In FU mode you use the rotary knob to control the rudder angle. Press the rotary knob, then turn the knob to set the rudder angle. The rudder moves to the commanded angle and then stop.

- You select FU mode from the autopilot pop-up

→ **Note:** If the autopilot pop-up is closed or if an alarm dialog is activated on the unit controlling the autopilot in FU mode, the autopilot automatically changes to STBY mode.

**Warning:** While in FU mode you cannot take manual control of the wheel.

## AUTO mode (auto compass)

In AUTO mode the autopilot issues rudder commands required to steer the vessel automatically on a set heading.

- You select AUTO mode from the autopilot pop-up. When the mode is activated, the autopilot selects the current boat heading as the set heading.

### Changing set heading in AUTO mode

You adjust the set heading by using the rotary knob, the Port/Starboard arrow buttons in the autopilot pop-up, or by selecting the Heading tile in the autopilot pop-up and then entering the desired heading value.

An immediate heading change takes place. The new heading is maintained until a new heading is set.

### Heading capture

When the vessel is turning in AUTO mode, an instant reset of the mode activates the heading capture function. This automatically cancels the turn, and the vessel continues on the heading read from the compass the very moment you re-activated the mode.

### Tacking in AUTO mode

→ **Note:** The tack function is only available when the system is set up for boat type SAIL in the Autopilot Commissioning dialog and is not available for NAC-1 autopilot computers.

Tacking should only be performed into the wind and must be tried out in calm sea conditions with light wind to find out how it works on your boat. Due to a wide range of boat characteristics (from cruising to racing boats) the performance of the tack function may vary from boat to boat.

Tacking in AUTO mode is different from tacking in WIND mode. In AUTO mode the tack angle is fixed and as defined by the user. For more details, see "*Tacking - WIND mode*" on page 50.

You initiate the tack function from AUTO mode.

When tacking direction is selected the autopilot changes the current set course according to the set fixed tacking angle.

You can interrupt the tack operation as long as the tack dialog is open by selecting the opposite tacking direction. When interrupted the boat returns to the previous set heading.

## NoDrift mode

NoDrift mode combines the autopilot and the positioning information from the GPS.

In NoDrift mode the vessel is steered along a calculated track line in a direction set by the user. If the vessel's heading is drifting away from the original heading due to current and/or wind, the vessel follows the line with a crab angle.

1. Turn the vessel to the desired heading
2. Activate the NoDrift mode. The autopilot draws an invisible bearing line based on current heading from the boat's position

Unlike in AUTO (compass) mode, the autopilot now uses the position information to calculate the cross track error, and automatically keeps your track straight.

You use the port/starboard arrow panel buttons in the autopilot pop-up or the rotary knob to reset the bearing line while in NoDrift mode.

### Dodging

If you need to avoid an obstacle when using NoDrift mode, you can set the autopilot to STBY and power steer or use the helm until the obstacle is passed.





If you return to NoDrift mode within 60 seconds you can select to continue on previous set bearing line.

If you do not respond, the dialog disappears and the autopilot goes to NoDrift mode with current heading as set bearing line.

## NAV mode

**⚠ Warning:** NAV mode should only be used in open waters.

You can use the autopilot to automatically steer the boat to a specific waypoint location, or along a pre-defined route. The position information from the GPS is used to change the course to steer to keep the boat on the track line and to the destination waypoint.

→ **Note:** To obtain satisfactory navigation steering, the NSS evo2 must have valid position input. Autosteering must be tested and determined satisfactory prior to entering the NAV mode.

### Start automatic navigating

When you start navigating a route or to a waypoint from the chart panel, you are prompted to set the autopilot to NAV mode. If you reject this request, you can start NAV mode from the autopilot mode menu.

When NAV mode is initiated, the autopilot automatically keeps the vessel on the leg.

When the vessel reaches the arrival circle for a routepoint, the autopilot gives an audible warning and displays a dialog with the new course information. If the required course change to the next waypoint is less than the Navigation change limit, the autopilot automatically changes the course. If the required course change to next waypoint in a route is more than the set limit, you are prompted to verify that the upcoming course change is acceptable.

→ **Note:** For information about navigation settings, refer to "Navigation settings" on page 43.

### Waypoint arrival circle

The Arrival radius defines the point at which a turn is initiated when you are navigating a route.

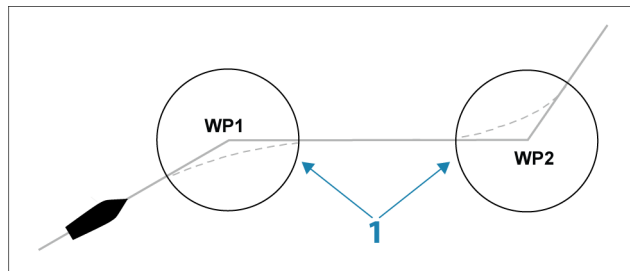

The arrival circle (1) should be adjusted according to boat speed. The higher the speed, the wider the circle. The intention is to make the autopilot start the heading change in due time to make a smooth turn onto the next leg.

The figure below may be used to select the appropriate waypoint circle when creating the route.

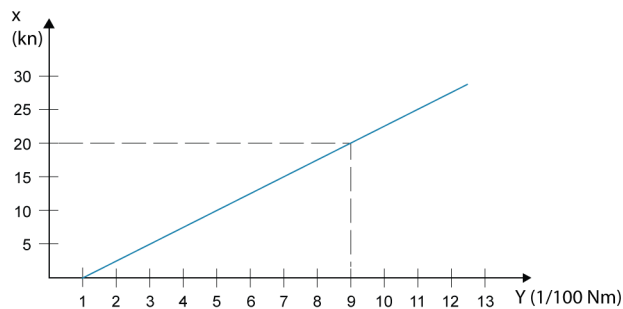

**X axis** = Boat speed in knots  
**Y axis** = Arrival circle, radius in 1/100 Nm

Example: With the speed of 20 knots you should use a waypoint circle with radius 0.09 Nm.

→ **Note:** The distance between any waypoints in a route must not be smaller than the radius of the waypoint arrival circle.

## WIND mode

→ **Note:** The WIND mode is only available if the system has been set up for sailboat in the Autopilot Commissioning dialog. This mode is not available for NAC-1 autopilot computers.

Before the WIND mode is started it must be verified that valid input from wind transducer is available.

Initiate wind steering as follows;

1. Switch the Autopilot to AUTO mode
2. Adjust the boat heading until wind angle is according to the angle you want to maintain
3. Select the mode indication in the autopilot controller to activate the autopilot menu, and select WIND mode

The set course to steer (CTS) and set wind angle are entered from the compass heading and the wind transducer at the moment the WIND mode is selected. From that point the autopilot changes the course to maintain the wind angle as the wind direction may change.

## Tacking in WIND mode

→ **Note:** The tack function is only available when the system is set up for boat type SAIL in the Autopilot Commissioning dialog and is not available for NAC-1 autopilot computers



Tacking should only be performed into the wind and must be tried out in calm sea conditions with light wind to find out how it works on your boat. Due to a wide range of boat characteristics (from cruising to racing boats) the performance of the tack function may vary from boat to boat.

Tacking in WIND mode as compared to AUTO mode is performed when sailing with apparent or true wind as the reference. The true wind angle should be less than 90 degrees.

The rate of turn during the tack will be given by the Tack time defined in the sailing parameter setup. The tack time is also controlled by the speed of the boat to prevent loss of speed during a tack.

You can initiate the tack function from WIND mode.

When you initiate the tacking, the autopilot immediately mirrors the set wind angle to the opposite side of the bow.

You can interrupt the tack operation as long as the tack dialog is open by selecting the opposite tacking direction. When interrupted, the boat returns to the previous set heading.

## Gybing

Gybing is possible when the true wind angle is larger than 120°.

The time to make a gybe is determined by the speed of the boat to make it as quick as possible within control.

## Tack and gybe prevent

You should use the autopilot with care when beating and running.

If the sails are unbalanced when beating, yaw forces from the sails can drive the boat into the wind. If the boat is driven beyond the set minimum wind angle, the thrust from the sails suddenly disappears and reduces the boat speed. The boat becomes more difficult to steer as the rudder becomes less effective.

The tack prevent function in WIND mode has been implemented to avoid such situations. It reacts immediately when the apparent wind angle becomes 5° less than the set minimum wind angle, and more rudder is commanded.

When running, it is difficult to steer the boat with waves coming sideways or from behind. The waves can yaw the boat into an unwanted gybe; this can be hazardous for both the crew and the mast.

The gybe prevent function is activated when the actual apparent wind angle becomes greater than 175° or gets opposite to the set wind angle. More rudder is commanded to prevent an unwanted gybe.

The tack and gybe prevent functions are not a guarantee against getting into a hazardous situation. If the effect of the rudder and/or drive unit is not adequate, a dangerous situation may occur. Pay particular attention in such situations.

## WIND Nav mode

→ **Note:** The **WIND Nav** mode is only available if the system has been set up for sailboat in the Autopilot Commissioning dialog. This mode is not available for NAC-1 autopilot computers.

In WIND Nav mode the autopilot steers the boat given both wind and position data.

In this mode the autopilot calculates the initial course change needed to navigate towards the active waypoint, but the pilot also utilizes the current wind direction in the calculation.

## Turn pattern steering

The autopilot includes a number of automatic turn steering features when the autopilot is in AUTO mode.

→ **Note:** The turn steering option is not available if the boat type is set to SAIL in the Autopilot Commissioning dialog, instead the tack/gybe feature is implemented.



### Initiating a turn

You start the turn by selecting the relevant turn icon, followed by selecting the port or starboard options in the turn dialog to select the turn direction.

### Stopping the turn

You can stop the turn from within the turn dialog.

At any time during a turn you can select **Autopilot standby** in the System Controls dialog to return to STBY mode and manual steering.

You can also stop a turn by pressing the **STBY/AUTO** key to return to STBY mode and manual steering.

### Turn variables

The turn steering options, except the C-turn, have settings that you can adjust before you start a turn and at any time when the boat is in a turn.

### U-turn

U-Turn changes the current set heading to be 180° in the opposite direction.

The turn rate is identical to Rate limit settings. This cannot be changed during the turn.

→ **Note:** Refer to the separate NSS evo2 Installation manual for information about Rate limit settings.

### C-turn

Steers the vessel in a circle.

You can adjust the Rate of turn from the turn dialog before the turn is initiated and during the turn. Increasing the turn rate makes the vessel turn a smaller circle.

### Spiral turn

Spiral-turn makes the vessel turn in a spiral with a decreasing or increasing radius. You set the initial radius before the turn is initiated, and the change per turn during the turn. If the change per turn is set to zero, the vessel turns in a circle. Negative values indicate decreasing radius while positive values indicate increasing radius.

### Zigzag turns

Steers the vessel in a zigzag pattern.

For navigating in a zigzag pattern, you set the initial heading change before the turn is started.

During the turn you can alter the main heading, the heading change, and the leg distance.

### Square turn

Makes the vessel automatically turn 90° after having travelled a defined leg distance.

At any time during the turn you can change the main heading and the distance of the leg until the vessel makes a new 90° turn.

### Lazy S-turn

Makes the vessel yaw around the main heading.

You set the selected heading change before the turn is started.

During the turn you can alter the main heading, the heading change and the turn radius from within the turn dialog.

### Depth contour tracking, DCT™

If the system has Echosounder input, the autopilot can be set to follow a depth contour.

**Warning:** Do not use this feature unless the seabed is suitable. Do not use it in rocky waters where the depth is varying significantly over a small area.

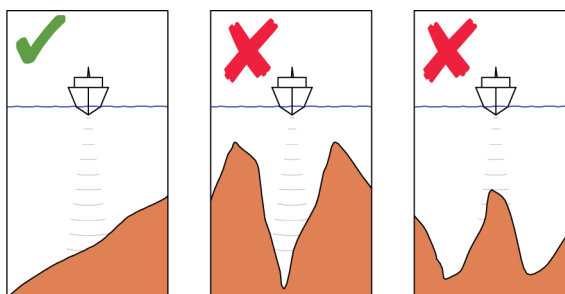

Use the following process to initiate DCT steering:

1. Ensure that you have depth reading on the panel or on a separate depth instrument.
2. Steer the boat to the depth you want to track, and in the direction of the depth contour.
3. Activate **AUTO** mode, select depth contour steering and monitor the depth reading.
4. Select the port or starboard option in the turn dialog to initiate the depth contour steering to follow the bottom sloping to starboard or to port:

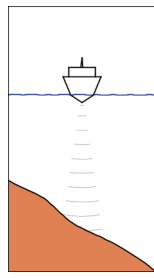

*Port option  
(depth decreases to port)*

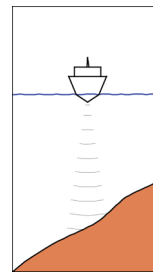

*Starboard option  
(depth decreases to starboard)*

The following parameters are available for depth contour tracking:

### Depth gain

This parameter determines the ratio between commanded rudder and the deviation from the selected depth contour. The higher depth gain value the more rudder is applied.

If the value is too small, it takes a long time to compensate for drifting off the set depth contour, and the autopilot fails to keep the boat on the selected depth.

If the value is set too high, the overshoot increases and the steering is unstable.

### Contour Cross Angle (CCA)

The CCA is an angle that is added to or subtracted from the set course.

With this parameter you can make the boat yaw around the reference depth with lazy-s movements.

The larger the CCA, the bigger yawing is allowed. If you the CCA set to zero there are no lazy-s movements.

## Using the NSS evo2 in an AP24/AP28 system

### Command transfer

If your NSS evo2 is connected to an autopilot system including an AP24 or AP28 control unit, only one control unit can be active at the same time. An inactive control unit is indicated with a square with a cross symbol in autopilot controller pop-up.

You take command from an inactive control unit by pressing the **STBY/AUTO** key to bring up the mode selection menu, and then confirming active mode.



### Locking remote stations

The AP24/AP28 includes a Remote Lock function that disables autopilot control from other units. A locked control unit is indicated with a key symbol in autopilot controller pop-up.

When the remote lock function is enabled on an AP24/AP28 control unit, only the active control unit stays in command. No transfer of command to NSS evo2 or other autopilot control units on the system can take place.

You can only unlock the remote stations from the AP24/AP28 unit in command.

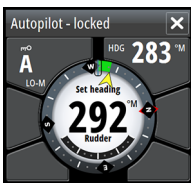

## Using the autopilot in an EVC system

When the NSS evo2 is connected to an EVC system via the SG05, you can take manual control of the steering regardless of the autopilot mode.

The mode indicator on the pilot pop-up is replaced by a dash to indicate EVC override.

The system returns to NSS evo2 control in standby mode if no rudder command is given from the EVC system within a predefined period.



## Autopilot settings

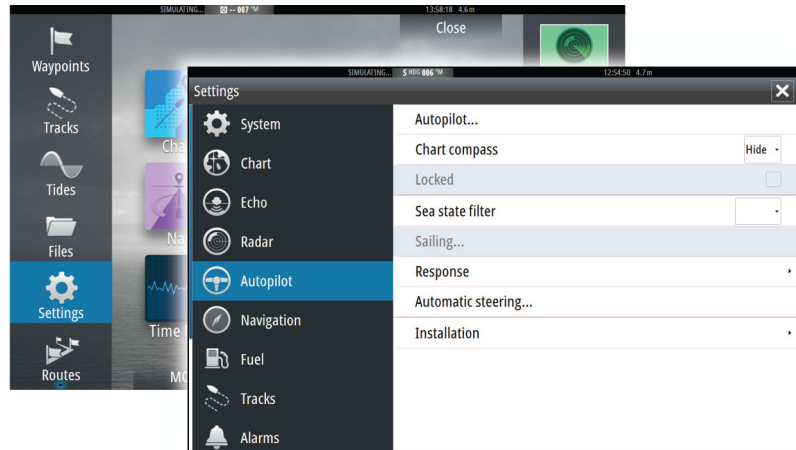

→ **Note:** Options shown on the Autopilot setting dialog varies depending on which autopilot computer is connected.

### Chart compass

You can select to show a compass symbol around your boat on the chart panel. The compass symbol is off when the cursor is active on the panel.

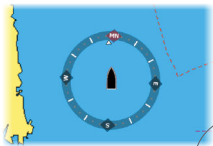

### Locking autopilot operation from a unit

You can lock a NSS evo2 unit to prevent unauthorized operation of the autopilot. When the unit is locked this is indicated with a lock symbol and with text in the pop-up. No automatic modes can be selected from a locked unit.

→ **Note:** The lock function is not available on a unit which has autopilot control!

If the NSS evo2 is part of an AP24/AP28 system, all other autopilot control units can be locked for autopilot control from the AP24/ AP28 control unit.

### Sea state filter

→ **Note:** This option is not available for NAC-1 autopilot computers.

The Seastate filter is used to reduce rudder activity and autopilot sensitivity in rough weather. Setting options are:

- **OFF**  
Seastate filter is disabled. This is the default setting.
- **AUTO**  
Reduces rudder activity and autopilot sensitivity in rough weather by an adaptive process. The AUTO setting is recommended if you want to use the seastate filter.
- **MANUAL**  
Linked to the steering response control settings described previously. It may be used to manually find the optimum combination of course keeping and low rudder activity in rough but steady sea conditions.

### Sailing parameters

→ **Note:** Sailing parameter settings are only available if the boat type is set to Sail in the Autopilot Commissioning dialog and are not available for NAC-1 autopilot computers.

#### Tack time

When performing a tack in WIND mode, the rate of turn (tack time) can be adjusted. This gives single-handed sailors time to handle the boat and the sails during a tack.

A turn performed without shifting wind side, is also made at a controlled turn rate.

### Tack angle

This value is used to preset the course change used when tacking in AUTO mode. By pressing the port and starboard indicators in the autopilot pop-up the course changes as much as this value.

### Wind function

With wind function set to AUTO, the autopilot automatically selects between apparent and true wind steering. AUTO is default and recommended for cruising.

When the boat is running, it is also surfing on the waves. This may lead to significant changes in boat speed, and thereby also changes in apparent wind angle. True wind steering is therefore used when running, while steering to apparent wind is used when beating or reaching.

Apparent wind steering is preferred when you want to achieve maximum boat speed. The autopilot tries to maintain a constant apparent wind angle to get maximum thrust from a given trim of the sails.

When sailing in closed waters, the apparent wind angle may change temporarily due to wind gusts. It may then be preferred to sail to the true wind.

### VMG optimizing

You can optimize the VMG to wind. When selected, the function is active for 5–10 minutes after a new wind angle has been set and only when beating.

### Layline steering

Layline steering is useful when navigating. Cross Track Error (XTE) from the navigator keeps the boat on the track line. If the XTE from the navigator exceeds 0.15 NM, the autopilot calculates the layline and track towards the waypoint.

### Response

→ **Note:** Not available for NAC-1 autopilot computers. NAC-1 uses the Steering response settings.

By default the system switches between HI/LO parameter set based on speed (motor boats) or speed and wind (sail boats). You can however manually select which parameter set that shall be used.

HI or LO must be selected if no speed input is available.

You can manually fine tune each of the two (HI/LO) parameter sets. Level 4 is default with parameter values as set by the autotune function. If no autotune is made (not recommended) the level 4 values are the factory default values.

A low response level reduces the rudder activity and provides a more “loose” steering.

A high response level increases the rudder activity and provides a more “tight” steering. A too high response level causes the boat to start lazy-s movements.

### Automatic steering

→ **Note:** Not available for NAC-1 autopilot computers.

This option displays an overview of all autopilot steering parameters, and you can adjust parameters if required.

For more details, refer to the separate NSS evo2 Installation manual.

### Installation

→ **Note:** Not available for NAC-1 autopilot computers.

Used for autopilot installation and commissioning. See the separate NSS evo2 Installation manual.

### Commissioning

→ **Note:** Only available for NAC-1 autopilot computers.

Used for commissioning the rudder or virtual rudder feedback.

## Steering response

→ **Note:** Only available for NAC-1 autopilot computers.

Used to increase or decrease the steering sensitivity. A low response level reduces the rudder activity and provides a more *loose* steering. A high response level increases the rudder activity and provides more *tight* steering. Too high a response level will cause the boat to make "S" movements.

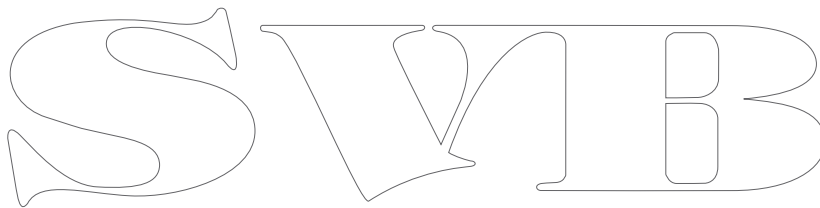



# 8

## Radar

The radar panel can be set up as a full screen view or combined with other panels.

The radar image can also be displayed as an overlay on a chart panel. For more information, see "Chart overlay" on page 27.

→ **Note:** Radar overlay requires data from the heading sensor.

### The radar panel

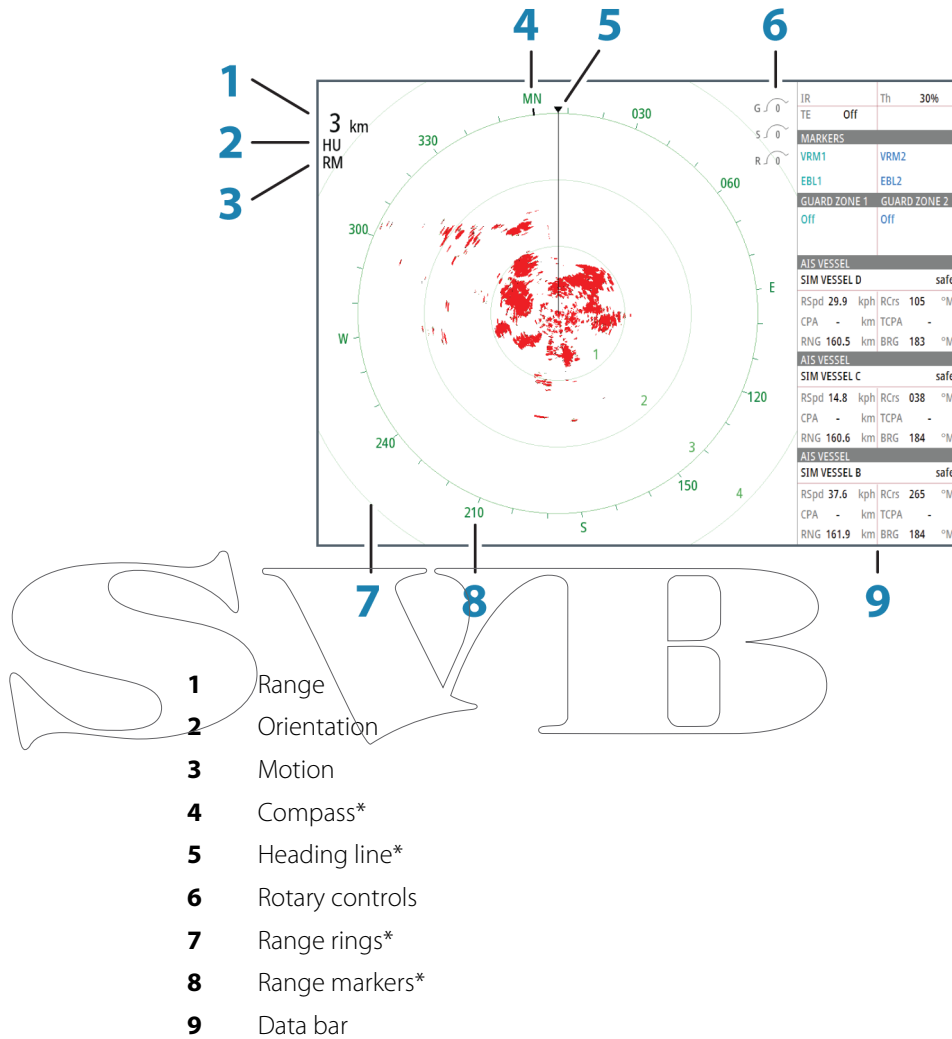

\* Optional radar symbology.

Radar symbology can be turned ON/OFF collectively from the Radar menu, or individually as described in "Radar settings panel" on page 66.

### Dual radar

You can connect to any combination of two supported radars and see both radar images at the same time.

→ **Note:** Interference will be seen on the Broadband Radar on most ranges when a pulse or Halo radar, and a Broadband radar are transmitting at the same time on the same boat. We recommend to only transmit on one radar at a time. For example, transmit Broadband radar for typical navigational usage, or pulse or Halo radar to locate weather cells, defined coastlines at a distance and to trigger Racons.

You can select a dual radar panel by pressing and holding the Radar application button on the **Home** page, or by creating a favorite page with two radar panels.

## Selecting the radar source

You specify the radar in the Radar panel by selecting one of the available radars in the radar source menu option. If you have a multiple Radar panel, the radar is set individually for each radar panel. Activate one of the radar panels, and then select one of the available radars in the radar source menu option. Repeat the process for the second radar panel, and select an alternative radar for this panel.

→ **Note:** The 3-digit radar source number is the last 3 digits of the radar's serial number.

## Radar overlay

You can overlay the Radar image on the Chart. This can help you to easily interpret the radar image by correlating the radar targets with charted objects.

When the radar overlay is selected, basic radar operational functions are available from the Chart panel's menu.

## Selecting radar overlay source on chart panels

To select the radar source of the radar overlay displayed on the chart panel, use the **Radar options** and then **Source** chart panel menu options to select the radar source.

For chart pages with more than one chart with radar overlay, it is possible to set up different radars sources for each chart panel. Activate one of the chart panels and then select one of the available radars in the radar source menu option. Repeat the process for the second chart panel with radar overlay, and select an alternative radar for this panel.

## Radar operational modes

The radar's operational modes are controlled from the NSS evo2 unit. The following modes are available:

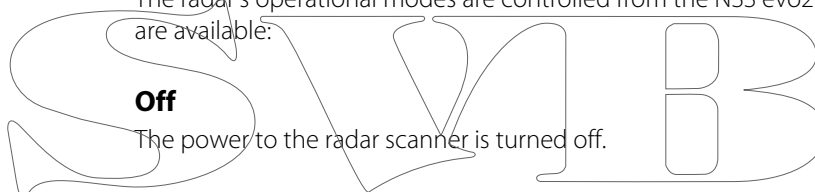

### Off

The power to the radar scanner is turned off.

### Standby

The power to the radar scanner is on, but the radar is not transmitting.

### Halo light

Controls the levels of the Halo Radar pedestal blue accent lighting. There are four levels possible for the lighting. The accent lighting can only be adjusted when the radar is in standby mode.

→ **Note:** The blue accent pedestal lighting might not be approved for use in your boating location. Check your local boating regulations before turning the blue accent lights ON.

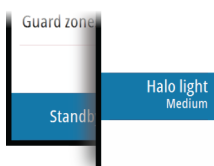

### Transmit

The scanner is on and transmitting. Detected targets are drawn on the radar PPI (Plan Position Indicator).

## Radar Range

You adjust radar range by turning the rotary knob or by selecting the zoom icons on the radar panel.

### Dual range

(Broadband 4G and Halo Radar only)

When connected to a Broadband 4G or Halo radar, it is possible to run the radar in Dual Range mode.

The radar appears in the radar sources menu as two virtual radar sources A and B. Range and radar controls for each virtual radar source are fully independent and the source can be

selected for a particular chart or radar panel in the same manner as dual radar described in "Selecting the radar source" on page 58.

→ **Note:** Some controls that are related to physical properties of the radar itself are not independent of source. These are Fast Scan, Antenna Height and Bearing alignment.

MARPA is fully independent and up to 10 targets may be tracked for each virtual radar source.

Up to two independent Guard Zones may also be defined for each virtual radar source.

## Using the cursor on a radar panel

By default, the cursor is not shown on a radar panel.

When you position the cursor on the radar panel, the cursor position window is activated and the cursor menu options are displayed.

To remove the cursor and cursor elements from the panel, select **Clear cursor** or press the **X** key.

### GoTo cursor

You can navigate to a selected position on the image by positioning the cursor on the panel, then using the **Goto Cursor** option in the menu.

### The Cursor assist function

The cursor assist function allows for fine tuning and precision placement of the cursor without covering details with your finger.

Press and hold your finger on the screen to switch the cursor symbol to a selection circle, appearing above your finger.

Without removing your finger from the screen, drag the selection circle over the desired item to display item information.

When you remove your finger from the screen the cursor reverts to normal cursor operation.

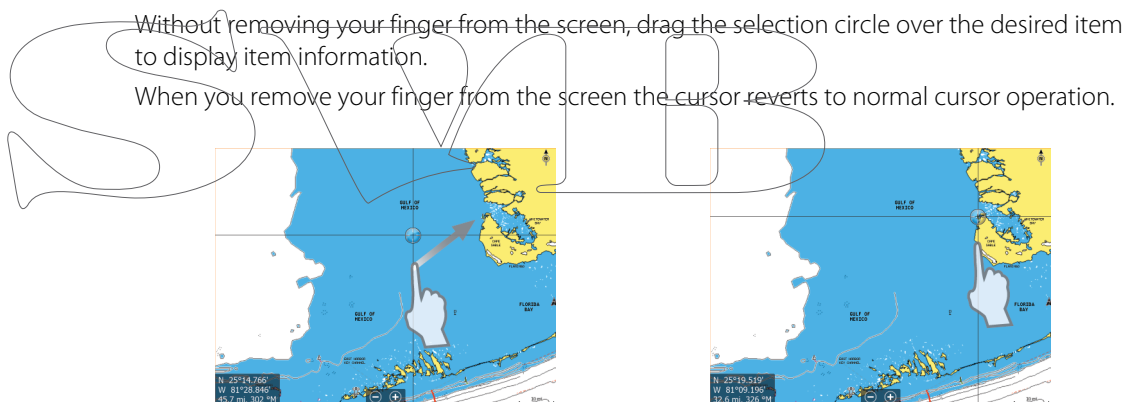

## Saving waypoints

You can save a waypoint at a selected location by positioning the cursor on the panel, and then selecting the new waypoint option in the menu.

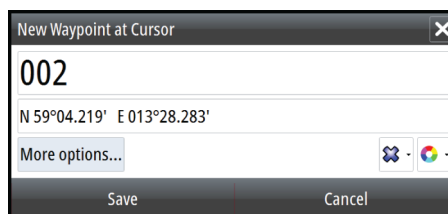

In the Chart and Nav panels, you can save a waypoint at the vessel position, when the cursor is not active, by selecting the new waypoint option in the menu.

If your unit has a **MARK** key, you can press this key to immediately save a waypoint. If the cursor is active, the waypoint is saved at the cursor position. If the cursor is not active, the waypoint is saved at your vessel's position.

## Radar sector blanking

(Halo Radar only)

You can define up to four sectors on the PPI inside which no radar data is transmitted. This enables you to blank-out interference caused by features on your boat or from a secondary radar. The blanking occurs on the main radar image and radar overlay on a chart. An enabled sector is shown as a magenta outline with 3 arcs crossing the blanking area. To specify radar sector blanking, refer to the Halo Radar Installation Manual.

→ **Note:** Radar sector blanking is only available for Halo radars.

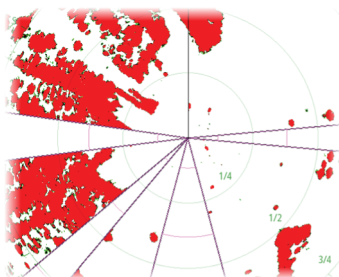

Main radar PPI



Radar overlay on a chart

## Adjusting the radar image

You may be able to improve the radar image by adjusting the radar sensitivity, and by filtering out the random echoes from sea and weather conditions.

The radar control images are located in the upper right corner of the radar panel. You can adjust the image settings by selecting the radar control image or by pressing the rotary knob. The selected control expands and displays its name in full and a slide bar is displayed. You can then adjust the value by turning the rotary knob or by using the slide bar.

You can also adjust the image settings from the radar menu.

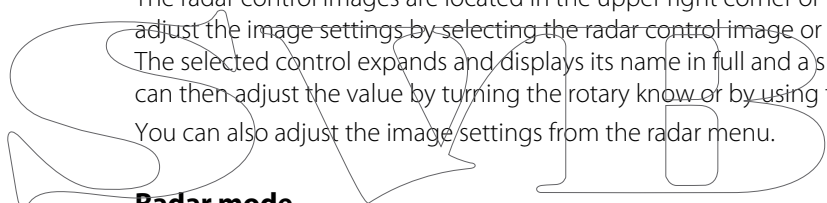
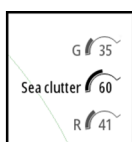

### Radar mode

(Halo Radar only)

Radar modes are available with default optimal control settings for different environments. The following modes are available:

- **Custom** - In this mode all radar controls can be adjusted and will be retained after a mode change or radar power cycle. Radar defaults are set for general purpose use.
- **Harbor** - In this mode the radar settings are optimized for areas such as busy waterways and large man-made structures where good target discrimination and rapid image updates are needed.
- **Offshore** - In this mode the radar settings are optimized for offshore sea conditions and making isolated targets larger and easy to see.
- **Weather** - In this mode the radar settings are optimized for best detection and presentation of rain clutter. Image update rate is slowed and color depth is increased.
- **Bird** - In this mode the radar settings are optimized for best detection of birds. The radar is set up for maximum sensitivity. This mode is not recommended for use in congested harbor environments.

Not all controls are adjustable in each mode. The following table shows preset controls and adjustability for each control.

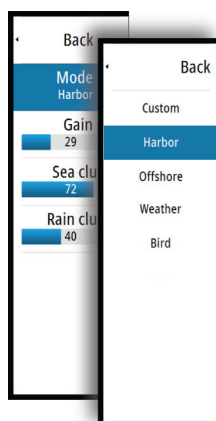

Mode:	Custom	Harbor	Offshore	Weather	Bird
<b>Control:</b>					
Range	Full*	Full*	Full*	Full*	Up to 24nm
Gain	Adjustable	Adjustable	Adjustable	Adjustable	Adjustable
Sea	Adjustable	Adjustable	Adjustable	Adjustable	Adjustable
Rain	Adjustable	Adjustable	Adjustable	Adjustable	Adjustable

Mode: Control:	Custom	Harbor	Offshore	Weather	Bird
Noise rejection	Adjustable	Medium	High	Medium	High
Threshold	Adjustable	30%	30%	0%	0%
Target Expansion	Adjustable	Low	Medium	Off	Off
Interference Reject	Adjustable	Adjustable	Adjustable	Adjustable	Adjustable
Target Separation	Adjustable	Medium	Off	Off	Off
Fast scan	Adjustable	High	High	Off	Off

\* Maximum range is dependent on antenna length; 3ft=48nm, 4ft=64nm and 6ft=72nm

### Modes in dual ranges

(Halo Radar only)

Modes can be set independently for each range. For example, you can have Offshore mode for range A and Weather mode for range B. However, interaction between ranges occurs in some cases:

- When using Bird mode for both ranges, maximum range is restricted to 24 NM and range resolution is reduced.
- Fast scan - The antenna rotation speed is set to the slower of the two modes selected. For example, Fast Scan is disabled when using Harbor and Weather modes because Fast Scan is Off in Weather mode.
- The Interference reject setting can affect the interference seen or removed on both ranges.

### Directional clutter rejection

(Broadband 4G Radar only)

This mode automatically works when GAIN = AUTO and SEA = HARBOR or OFFSHORE. The purpose is to allow smaller vessels to be seen in the leeward direction of the sea clutter. The GAIN of the radar receiver is increased dynamically during the sweep, in the leeward direction, for increased target sensitivity in heavier sea states.

When GAIN or SEA = MANUAL, the Directional Clutter Rejection mode will be OFF (non-directional).

In addition, CALM, MODERATE or ROUGH STC Curve settings are available in the Radar options menu to better optimize the radar image to your liking.

### Gain

The gain controls the sensitivity of the radar receiver.

A higher gain makes the radar more sensitive to radar returns, allowing it to display weaker targets. If the gain is set too high, the image might be cluttered with background noise.

Gain has a manual and an automatic mode. You toggle between automatic and manual mode in the slide bar, or by pressing and holding the rotary knob.

### Sea clutter

Sea clutter is used to filter the effect of random echo returns from waves or rough water near the vessel.

When you increase Sea clutter, filtering the on-screen clutter caused by the echoes of waves is reduced.

The system includes predefined Sea clutter settings for harbor and offshore conditions for all radar systems except Halo, in addition to the manual mode where you can adjust the settings. For all radar systems except Halo, you select Sea clutter modes from the menu, or by a long press on the rotary knob. You can only adjust the Sea clutter value in manual mode.

## Auto Sea Offset

(Halo Radar only)

To allow fine tuning of the Sea control while in Auto mode (Auto uses directional adaptive clutter rejection), the Auto setting may be offset.

## Rain clutter

Rain clutter is used to reduce the effect of rain, snow or other weather conditions on the radar image.

The value should not be increased too much as this may filter out real targets.

## Advanced radar options

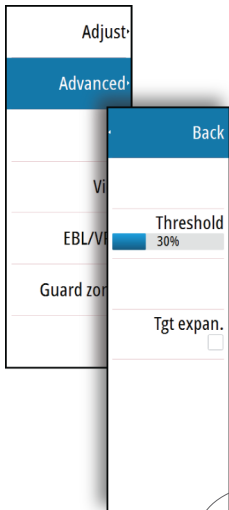

### Noise Rejection

(Broadband 4G and Halo radar only)

The Noise Rejection control sets the amount of noise filtering applied by the radar. Target sensitivity is increased at longer ranges when this control is set to Low or High, but does cause some loss of target discrimination.

**Tip:** To get maximum range performance from Broadband 4G Radar, transmit on one range only, set the Noise Reject control to High and the threshold as low as possible. The default is 30% for less clutter on the screen. If OFF is selected for the NSS evo2, the range performance is about equal to 3G radar. In some areas where extreme high interference may exist, try OFF for best radar image.

### Radar threshold

The threshold sets required signal strength for the lowest radar signals. Radar returns below this limit are filtered and are not displayed.

Default value: 30%.

### Target expansion

Target expansion increases the length of targets in range, making them easier to see.

### Rejecting radar interference

Interference could be caused by radar signals from other radar units operating in the same frequency band.

A high setting reduces the interference from other radars.

In order not to miss weak targets, the interference rejection should be set to low when no interference exists.

### Target separation

(Broadband 4G and Halo Radar only)

The **Target separation** control allows you to control the target discrimination of the radar (separation between objects is more prominent).

### Fast scan

(Broadband Radar only).

Sets the speed of the radar antenna rotation. This option gives faster target updates.

→ **Note:** Maximum speed may not be achieved depending on the radar Settings, Mode, and Range selected. The radar will only rotate as fast as the current control settings allow.

### Sea State

Set the Sea State control according to current sea conditions for best sea clutter rejection.

### Target boost

(3G and 4G Broadband, and Pulse Radar only)

The target boost control increases pulse length or reduces radar bandwidth to make targets appear larger in range and increase radar sensitivity.

## Radar view options

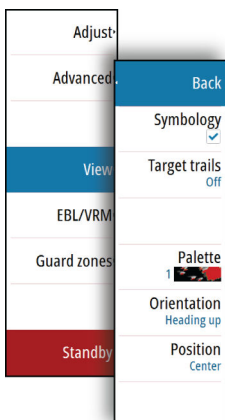

### Radar symbology

Radar symbology defined in the Radar Settings panel can be turned on/off collectively. See the radar panel illustration showing optional radar items.

### Target trails

You can set how long the trails generated from each target on your radar panel remain. You can also turn OFF target trails.

→ **Note:** True motion is recommended when using Target trails

### Clearing target trails from the panel

When target trails are displayed on the panel, the radar menu expands to include an option where you can clear target trails from your radar panel temporarily. The target trails start to appear again unless you switch them off as described above.

### The radar palette

Different colors (palettes) can be used to represent detail on your radar panel.

### Radar orientation

Radar orientation is indicated on the upper left corner of the radar panel as either HU (Heading UP), NU (North Up) or CU (Course up).

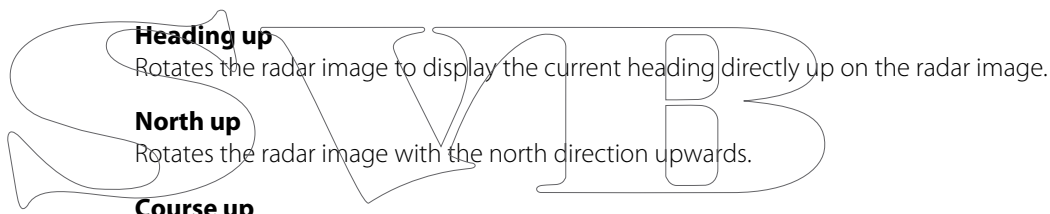

### Course up

Rotates the radar image to display the current navigation course directly up.

This option works only when the system is navigating an active route. If you are not navigating an active route, the heading up orientation is used until the navigation function is started.

### Positioning the radar center

You can move the radar PPI (Plan Position Indicator) center to different positions within the radar panel, and select how your vessel symbol moves on the radar image.

Radar motion is indicated on the upper left corner of the radar panel as either TM (True motion) or RM (Relative motion).

The radar position can only be changed when the radar is transmitting.

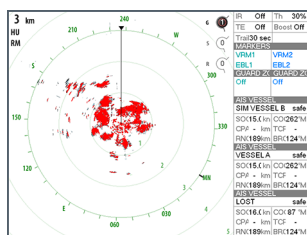

Center

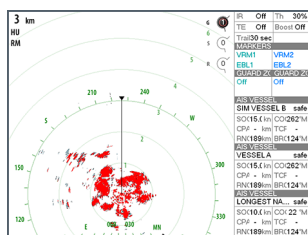

Look ahead

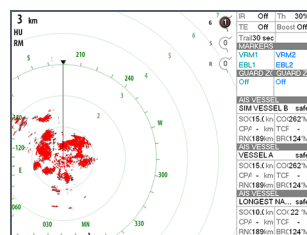

Custom offset

### Center

Default setting. The radar PPI center is centered on the radar panel.

### Look Ahead

Moves the radar PPI center to the bottom of the panel to maximize the view ahead.

### Offset

Allows you to move the PPI center to any location on the radar panel.

1. Select the offset option from the menu
2. Move the cursor to where you want to position the radar center
3. Confirm the setting by selecting the save offset option in the menu.

### True motion

In True motion, your vessel and moving targets move across the Radar screen as you travel. All stationary objects remain in a fixed position. When the vessel's symbol reaches the edge of the screen, the radar image is redrawn with the vessel symbol repositioned in the center of the screen.

When True motion is selected, the menu expands to include a reset true motion option. This allows for manually resetting the radar image and vessel symbol to the center of the screen.

### EBL/VRM markers

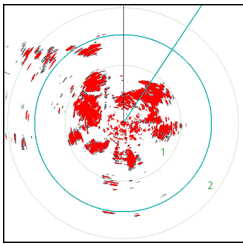

The electronic bearing line (EBL) and variable range marker (VRM) allows quick measurements of range and bearing to vessels and landmasses within radar range. Two different EBL/VRMs can be placed on the radar image.

The EBL/VRMs are by default positioned from the center of the vessel. It is, however, possible to offset the reference point to any selected position on the radar image.

When positioned, you can turn the EBL/VRM on/off by selecting the relevant markers on the data bar, or by deselecting the marker from the menu.

### Defining an EBL/VRM marker

1. Ensure that the cursor is not active
2. Activate the menu, select **EBL/VRM**, then select **EBL/VRM 1** or **EBL/VRM 2**
  - The EBL/VRM is now positioned on the radar image
3. Select the adjustment option from the menu if you need to reposition the marker, then adjust the marker by dragging it into position on the radar image
4. Select the save option in the menu to save your settings

### Placing EBL/VRM markers by using the cursor

1. Position the cursor on the radar image
2. Activate the menu
3. Select one of the EBL/VRM markers
  - The EBL line and the VRM circle are positioned according to the cursor position.

### Offsetting an EBL/VRM marker

1. Ensure that the cursor is not active
2. Activate the menu, select **EBL/VRM**, then select the marker you wish to offset
3. Select the set offset option
4. Position the cursor on the radar panel to set the offset position
5. Select the save option in the menu to save your settings.

You can reset the EBL/VRM center to vessel position from the menu.

### Setting a guard zone around your vessel

A guard zone is an area (either circular or a sector) that you can define on the radar image. When activated, an alarm alerts you when a radar target enters or exits the zone.

### Defining a guard zone

1. Ensure that the cursor is not active
2. Activate the menu, select **Guard zones**, then select one of the guard zones
3. Select the shape for the zone
4. Select **Adjust** to set the range and depth for the guard zone. The values can be set from the menu or by dragging on the radar panel
5. Select the save option in the menu to save your settings.

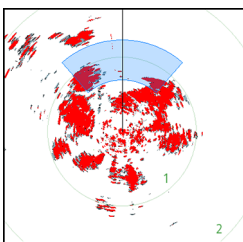



When positioned, you can turn the guard zones on/off by selecting the relevant section on the data bar.

### Alarm settings

An alarm is activated when a radar target breaches the guard zone limits. You can select if the alarm is activated when the target enters or exits the zone.

### Sensitivity

The guard zone sensitivity can be adjusted to eliminate alarms for small targets.

## MARPA targets

If the system includes a heading sensor, the MARPA function (Mini Automatic Radar Plotting Aid) can be used to track up to ten radar targets.

You can set alarms to notify you if a target gets too close. Refer to *"Radar settings"* on page 66.

MARPA tracking is an important tool for collision avoidance.

→ **Note:** MARPA requires heading data for both the radar and the NSS evo2.

### MARPA target symbols

The system uses the target symbols shown below.

	Acquiring MARPA target. Typically it takes up to 10 full rotations of the scanner.
	Tracking MARPA target, not moving or at anchor.
	Tracking and safe MARPA target with extension lines.
	Dangerous MARPA target. A target is defined as dangerous when it enters the guard zone defined on the radar panel.
	When no signals have been received within a time limit a target will be defined as lost. The target symbol represents the last valid position of the target before the reception of data was lost.
	Selected MARPA target, activated by positioning the cursor on the target icon. The target returns to the default target symbol when the cursor is removed.

### Tracking MARPA targets

1. Position the cursor on the target on the radar image
2. Select **Acquire targets** from the menu
3. Repeat the process if you want to track more targets

After your targets are identified, it may take up to 10 radar sweeps to acquire and then track the target.

### Cancelling MARPA target tracking

When targets are being tracked, the radar menu expands to include options for cancelling individual targets or to stop the tracking function.

Cancel tracking individual targets by selecting the target icon before activating the menu.

### Viewing MARPA target information

If the pop-up is activated, you can select a MARPA target to display basic target information. Information for the 3 MARPA targets closest to the vessel is also displayed in the data bar.

When a target is selected, detailed information for the target can be displayed from the menu.

You can display information about all MARPA targets by using the **Vessels** option on the Home page.

### MARPA alarm settings

You can define the following MARPA alarms:

- **MARPA target lost**  
Controls whether an alarm is activated when a MARPA target is lost.
- **MARPA unavailable**  
Controls whether an alarm is activated if you do not have the required inputs for MARPA to work (valid GPS position and heading sensor connected to the radar server).

### Recording radar data

You can record radar data and save the file internally in the NSS evo2 unit, or save it onto an SD card inserted into the unit's card reader.

A recorded radar file can be used for documenting an event or an operational error. A logged radar file can also be used by the simulator.

If more than one radar is available, you can select which source you want to record.

### Radar settings

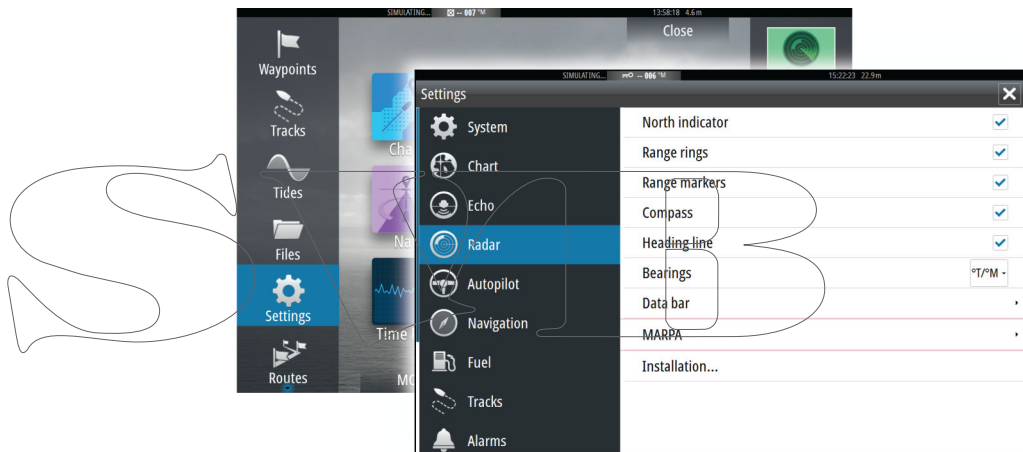

### Radar symbology

You can select which optional radar items that should be turned on/off collectively from the menu. Refer to the Radar panel illustration.

### Bearings

Used for selecting whether the radar bearing should be measured in relation to True/Magnetic North (°T/°M) or to your relative heading (°R).

### Data bar

Turns on/off the radar data bar. Refer to the radar panel illustration.

The data bar can show up to 3 targets, arranged with the most dangerous targets on top. You can select to show MARPA targets on top and before any AIS targets, even if the AIS targets are closer to your vessel.

### MARPA settings

You can define the length of the MARPA trail making it easier to follow target movement.

A circle can be added around your vessel to present the danger zone. The radius of the ring is the same as the closest point of approach as set in the Dangerous Vessels dialog. Refer to *"Defining dangerous vessels"* on page 94. An alarm triggers if a vessel is tracking into your safe zone.

## **Installation**

The Installation option is used for radar installation, described in the separate Radar or NSS evo2 Installation manuals.

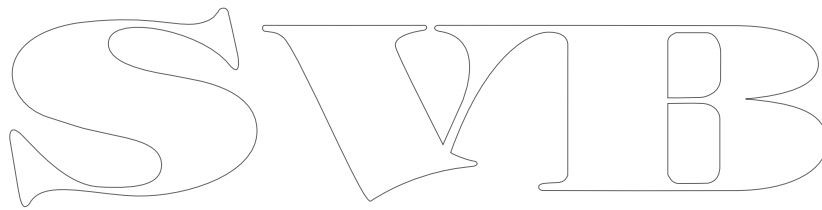
A large, stylized outline logo consisting of the letters 'S', 'W', 'I', and 'B' in a decorative, serif font. The letters are hollow and have a classic, elegant appearance.

# 9

## Echosounder

The Echosounder function provides a view of the water and bottom beneath your vessel, allowing you to detect fish and examine the structure of the sea floor.

All NSS evo2 units - except for mapping units - have built in CHIRP echosounder and StructureScan. NSS evo2 mapping units must have a compatible external echosounder module, or another NSS evo2 with built-in CHIRP echosounder and StructureScan, available on the network to be able to use echosounder functionality.

Note that StructureScan and CHIRP cannot be operated simultaneously on NSS evo2 units with built-in echosounder functionality. If simultaneous operation is desired, an external module such as SonarHub, BSM-3 or other compatible modules, or a second NSS evo2 must be fitted.

### The Echosounder image

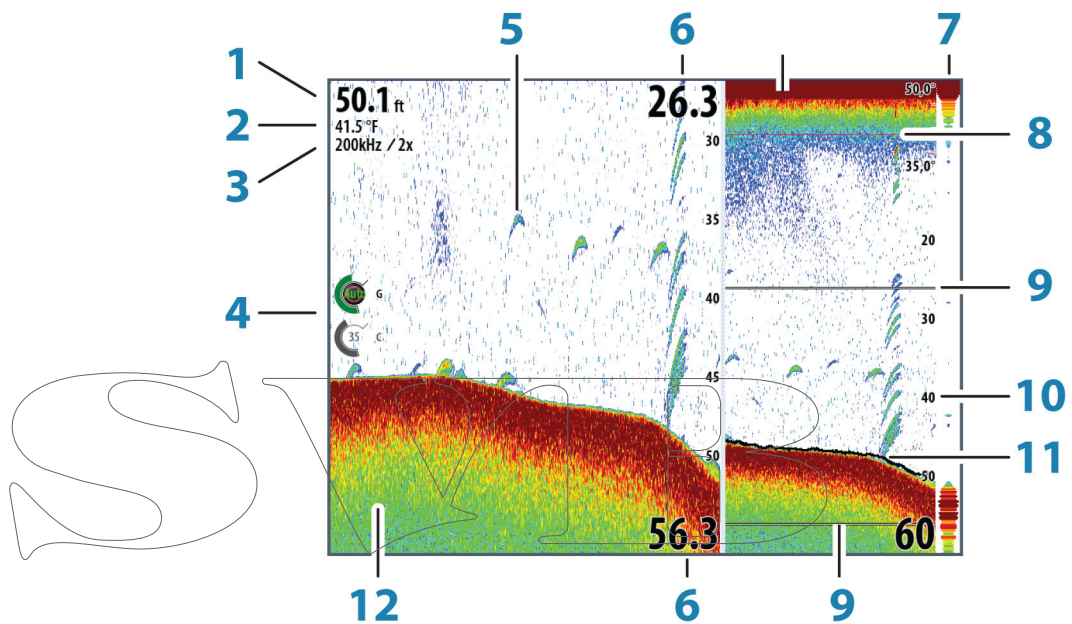

- 1 Depth
- 2 Temperature
- 3 Frequency / Zoom
- 4 Gain / Color adjustment icons
- 5 Fish arches
- 6 Upper and Lower range
- 7 A-Scope\*
- 8 Temperature graph\*
- 9 Zoom bars\*
- 10 Range scale
- 11 Depth line\*
- 12 Bottom

\* Optional Echosounder image items.

→ **Note:** You turn the optional Echosounder images on/off individually. Refer to "Echosounder Settings" on page 75.

### Zooming the Echosounder image

You can zoom the Echosounder image by:

- turning the rotary knob
  - using the panel zoom icons
  - pinching or spreading on the screen
- Zoom level is shown on the upper left side of the panel.

When zooming in, the sea floor is kept near the bottom of the screen, irrespective of whether it is in auto-range or manual range.

If the range is set considerably less than the actual depth, the unit is not able to find the bottom when zooming.

If the cursor is active, the unit zooms in where the cursor is pointed.

### Zoom bar

The zoom bar is displayed when you zoom the Echosounder image.

Drag the zoom bar vertically to view different parts of the water column.

## Using the cursor on the Echosounder panel

The cursor can be used to measure a distance to a target, to mark a position, and to select targets.

By default, the cursor is not shown on the Echosounder image.

When you position the cursor on the Echosounder image; the screen pauses, the depth at the cursor position is shown, and the information window and the history bar are activated.

To remove the cursor and cursor elements from the panel, select **Clear cursor** or press the **X** key.

### GoTo cursor

You can navigate to a selected position on the image by positioning the cursor on the panel, then using the **Goto Cursor** option in the menu.

### The Cursor assist function

The cursor assist function allows for fine tuning and precision placement of the cursor without covering details with your finger.

Press and hold your finger on the screen to switch the cursor symbol to a selection circle, appearing above your finger.

Without removing your finger from the screen, drag the selection circle over the desired item to display item information.

When you remove your finger from the screen the cursor reverts to normal cursor operation.

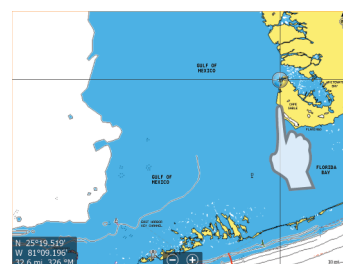
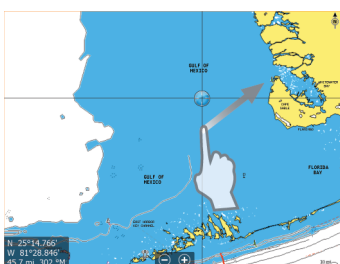

### Measuring distance

The cursor can be used to measure the distance between the position of two observations on the image.

It is easier to use the measuring function when the image is paused.

1. Position the cursor on the point from where you want to measure the distance
2. Start the measuring function from the menu
3. Position the cursor on the second measuring point
  - A line is drawn between the measuring points, and the distance is listed in the Information window
4. Continue selecting new measuring points if required

You can use the menu to re-position the start point and the end point as long as the measuring function is active.

When you select **Finish measuring** or press the **X** key, the image resumes to normal scrolling.

## Saving waypoints

You can save a waypoint at a selected location by positioning the cursor on the panel, and then selecting the new waypoint option in the menu.

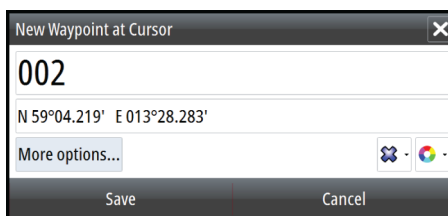

In the Chart and Nav panels, you can save a waypoint at the vessel position, when the cursor is not active, by selecting the new waypoint option in the menu.

If your unit has a **MARK** key, you can press this key to immediately save a waypoint. If the cursor is active, the waypoint is saved at the cursor position. If the cursor is not active, the waypoint is saved at your vessel's position.

## Viewing Echosounder history

Whenever the cursor is shown on the Echosounder panel, the scroll bar is shown at the top of the panel. The scroll bar shows the image you are currently viewing in relation to the total Echosounder image history stored.

If the scroll bar is on the far right side, it indicates that you are viewing the latest soundings. If you position the cursor to the left side of the screen, the history bar starts scrolling towards the left, and the automatic scrolling as new soundings are received is turned off.

You can view echosounder history by panning the image.

To resume normal scrolling, select **Clear cursor** or press the **X** key.

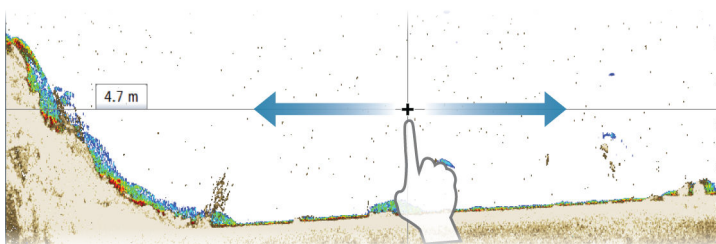

## Setting up the Echosounder image

Use the Echosounder menu options to set up the image. When the cursor is active, some options on the Echosounder menu are replaced with cursor mode features. Select **Clear cursor** to return to the normal Echosounder menu.

### The range

The range setting determines the water depth that is visible on the screen.

### Auto range

By default, the range is set to Auto. With Auto, the system automatically displays the whole range from the water surface to the bottom. Auto is the preferred setting for most fish finding sonar use.

### **Preset range levels**

Allows for the selection of a specific depth range that is not tied to the depth of the water.

### **Custom range**

This option allows you to manually set both upper and lower range limits.

- **Note:** Setting a custom range puts the sonar in manual mode. If the bottom is well beyond the lower range set, you may lose digital depth.

### **Echosounder frequency**

The NSS evo2 unit supports several transducer frequencies. Available frequencies depend on the transducer model that is connected.

You can view two frequencies at the same time by selecting dual Echosounder panels from the **Home** page.

### **Color and gain settings**

Gain and Color control images are located in the left side of the Echosounder panel. You activate the control by tapping the image. Active control expands and displays its name in full. You can then adjust the value by using the slide bar.

You can also adjust the image settings from the Echosounder menu.

#### **Gain**

The gain controls the sensitivity of the Echosounder.

The more you increase the gain, the more details are shown on the image. However, a higher gain setting may introduce more background clutter on the image. If the gain is set too low, weak echoes might not be displayed.

#### **Auto gain**

The Auto gain option keeps the sensitivity at a level that works well under most conditions. With the gain in auto mode, you can set a positive or negative offset that gets applied to the auto gain.

#### **Color**

Strong and weak echo signals have different colors to indicate the different signal strengths. The colors used depend on which palette you select.

The more you increase the Color setting, the more echoes is displayed in the color at the strong return end of the scale.

### **Pausing the Echosounder**

You can pause the Echosounder, allowing you to examine the Echosounder echoes.

This function is useful when you need to position a waypoint exactly on the Echosounder panel, and if you are using the cursor to measure a distance between 2 elements on the image.

## **Advanced Echosounder options**

The Advanced option is only available when the cursor is not active.

### **Noise rejection**

Signal interference from bilge pumps, engine vibration and air bubbles can clutter the image.

The noise rejection option filters the signal interference and reduces the on-screen clutter.

### **TVG**

The TVG (Time Variable Gain) option compensates for distance to the object, making echoes from equal sized objects appear with the same size on the echosounder image.

## Scroll speed

You can select the scrolling speed of the Echosounder image on the screen. A high scroll speed updates the image fast, while a low scroll speed presents a longer history.

- **Note:** In certain conditions it may be necessary to adjust the scroll speed to get a more useful image. Such as adjusting the image to a faster speed when vertically fishing without moving.

## Ping speed

Ping speed controls the rate the transducer transmits the Echosounder signal into the water. By default, the ping speed is set to max. It may be necessary to adjust the ping speed to limit interference or to adjust for specific fishing conditions.

## Start recording log data

You can start recording of Echosounder and StructureScan log data and save the file internally in the NSS evo2 unit, or save it onto a card inserted into the unit's card reader.

The function is activated from the **Advanced** menu option.

When the data is being recorded, there is a flashing red symbol in the top left corner and a message appears periodically at the bottom of the screen.

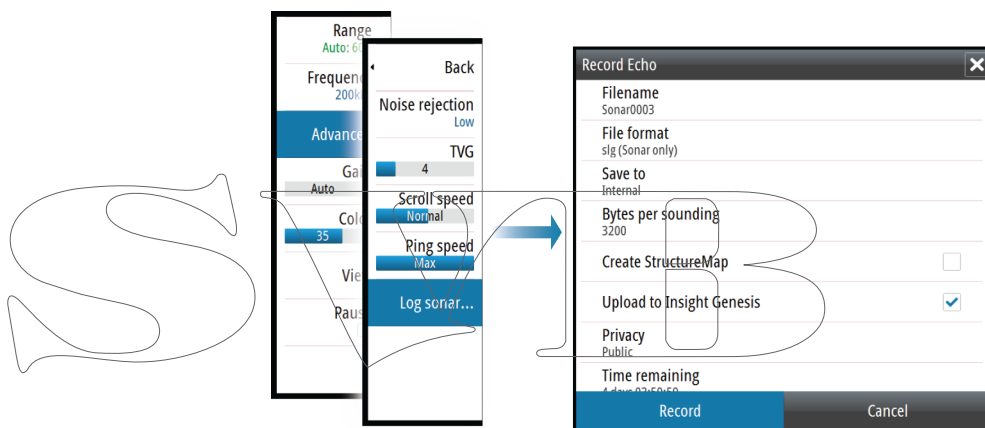

## Filename

Specify the name of the recording (log).

## File format

Select a file format from the drop-down, slg (Echosounder only), xtf (Structure only\*), sl2 (Echosounder and Structure) or sl3 (includes ForwardScan).

- **Note:** XTF format is for use only with select 3rd party Echosounder viewing tools.

## Save to

Select whether the recording is to be saved internally or to a memory card in the card reader.

## Bytes per sounding

Select how many bytes per seconds that are to be used when saving the log file. More bytes yield better resolution, but cause the record file to increase in size compared to using lower byte settings.



## Create StructureMap

If StructureScan is available on the network, you can convert the .sl2 logs to StructureMap format (.smf) when recording completes. The log file can also be converted to StructureMap format from the Files option.

## Upload to Insight Genesis

Files are transmitted to Insight Genesis when recording completes, if you are connected to a wireless hotspot. For information about wireless hotspots, refer to "*Wireless connection*" on page 87.

## Privacy

If allowed by your selected Insight Genesis account, you can choose between setting the recorded log files as Private or Public at Insight Genesis.

## Time remaining

Shows the remaining allocated space available for recordings.

## Stop recording log data

Select **Stop** in the Recording Echo dialog to fully stop the recording of all echosounder data.

- **Note:** If you have selected the **Upload to Insight Genesis** option and are connected to a wireless hotspot, your recorded files are transmitted to Insight Genesis when you select **Stop**.

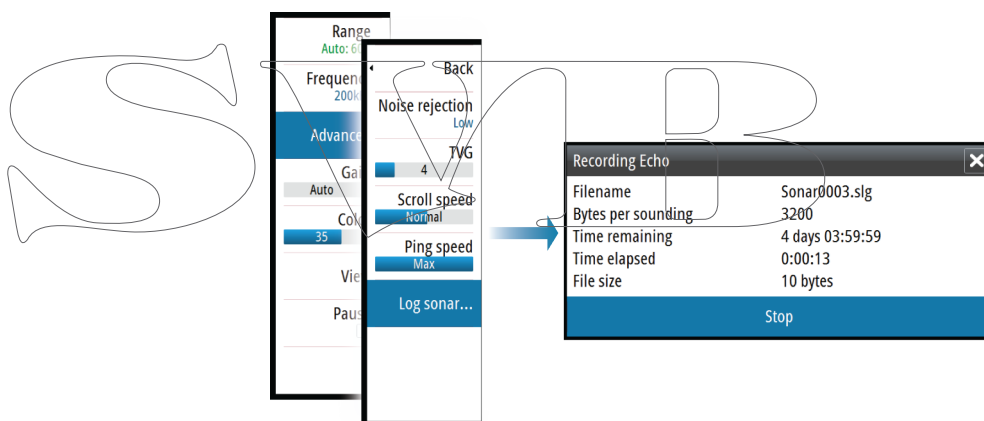

## Viewing the recorded sounder data

Both internally and externally stored sounder records may be reviewed when selected.

The log file is displayed as a paused image, and you control the scrolling and display from the replay menu option.

You can use the cursor on the replay image, and pan the image as on a normal echo image.

If more than one channel was recorded in the selected echo file, you can select which channel to display.

You exit the replay mode by pressing the **X** key or by selecting the **X** symbol in the upper right corner of the replay image.

## Echosounder View options

### Split screen options

#### Zoom

The Zoom mode presents a magnified view of the sounder image on the left side of the panel.

By default the zoom level is set to 2x. You can select up to 8x zoom from the drop-down menu, using the +/- keys, or the zoom (+ or -) buttons.

The range zoom bars on the right side of the display shows the range that is magnified. If you increase the zooming factor the range is reduced. You see this as reduced distance between the zoom bars.

### Bottom lock

The bottom lock mode is useful when you want to view echoes close to the bottom. In this mode the left side of the panel shows an image where the bottom is flattened. The range scale is changed to measure from the seabed (0) and upwards. The bottom and the zero line are always shown on the left image, independent of the range scale. The scaling factor for the image on the left side of the panel is adjusted as described for the Zoom option.

### Palettes

You can select between several display palettes optimized for a variety of fishing conditions.

### Temperature graph

The temperature graph is used to illustrate changes in water temperature.

When toggled on, a colored line and temperature digits are shown on the Echosounder image.

### Depth line

A depth line can be added to the bottom surface to make it easier to distinguish the bottom from fish and structures.

### A-Scope

The A-scope is a display of real-time echoes as they appear on the panel. The strength of the actual echo is indicated by both width and color intensity.

### Zoom bars

The zoom bars shows the range that is magnified on a split panel with zoom view.

### Fish ID

You can select how you want the echoes to appear on the screen. You can also select if you want to be notified by a beep when a fish ID appears on the panel.

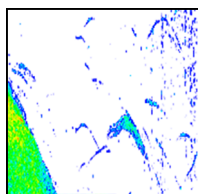

*Traditional fish echoes*

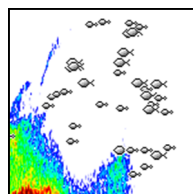

*Fish symbols*

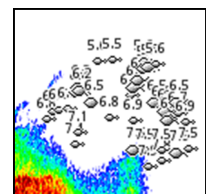

*Fish symbols and depth indication*

→ **Note:** Not all fish symbols are actual fish.

## Echosounder settings

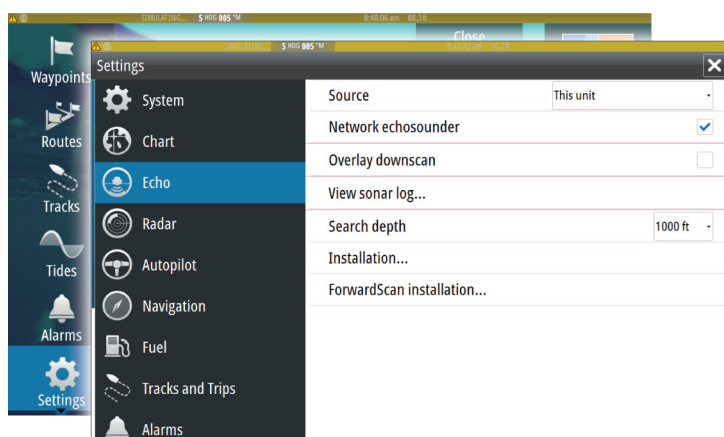

### Echosounder source

If you have Network Echosounder enabled, you can select which Echosounder to be the preferred source on this NSS evo2 unit.

### Network Echosounder

You can share the Echosounder connected to this NSS evo2 unit on the network.

For more information about how to setup Echosounder, refer to the separate NSS evo2 Installation manual.

### Overlay downscan

When a DownScan source is connected to your system, you can overlay DownScan images on the regular Echosounder image.

When activated, the Echosounder menu expands to include basic DownScan options.

### View Echosounder log

Used to view Echosounder recordings. The log file is displayed as a paused image, and you control the scrolling and display from the menu.

You can use the cursor on the image, measure distance, and set view options as on a live Echosounder image. If more than one channel was recorded in the selected Echosounder file, you can select which channel to display.

You exit the view function by selecting the **X** in the upper right corner.

### Search depth

Noise may cause the Echosounder to search for unrealistic depths.

By setting the search depth manually the system displays echoes received from objects within the set depth range.

### Installation

Used for installation and setup. See the separate NSS evo2 Installation manual.

### ForwardScan Installation

Used for ForwardScan installation and setup. Refer to the "*ForwardScan setup*" on page 85.

# 10

## StructureScan

StructureScan HD uses high frequencies to provide a high resolution, picture-like image of the seabed.

StructureScan provides a 150 m (480 ft) wide coverage in high detail with SideScan, while the DownScan provides picture perfect images of structure and fish directly below your boat, down to 90 m (300 ft).

All NSS evo2 units - except for mapping units - have built-in StructureScan. NSS evo2 mapping units must have a compatible external StructureScan module available on the network to use the StructureScan features.

### The StructureScan image

#### The view

The StructureScan panel can be set up as a DownScan image, or showing left/right side scanning.

The DownScan image can also be added as an overlay to the traditional Echosounder image.

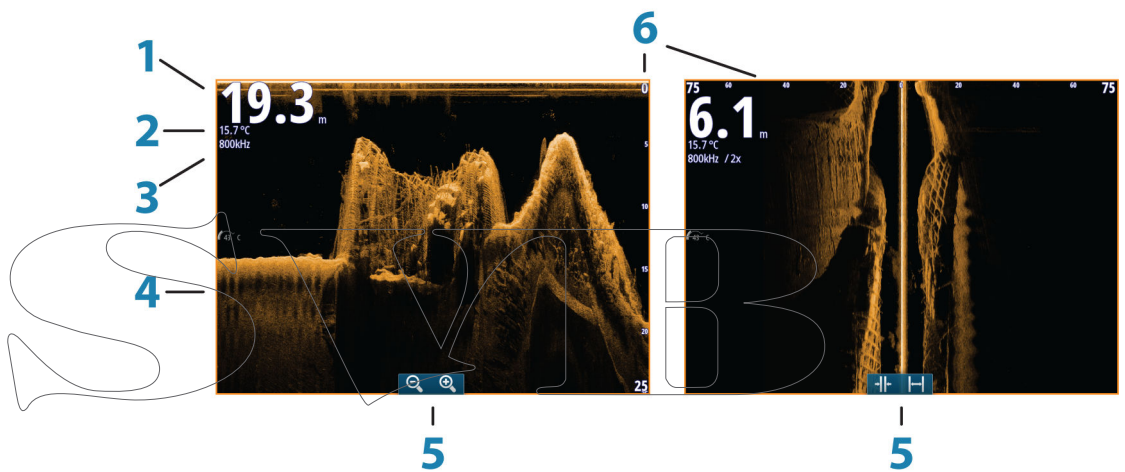

- 1 Depth
- 2 Temperature
- 3 Frequency
- 4 Bottom
- 5 Zoom (downscan) / Range (sidescan) icons
- 6 Range scale

### Zooming the StructureScan image

You can zoom a StructureScan image by:

- turning the rotary knob when the cursor is not active
  - using the panel zoom icons
  - by pinching or spreading on the screen
- Zoom level is shown on the upper left side of the panel.

### Using the cursor on the StructureScan panel

By default, the cursor is not shown on the StructureScan image.

When you position the cursor on a DownScan image; the screen pauses, the cursor information window and the history bar are activated. On a DownScan image, the depth is shown at cursor position.

When you position the cursor on a SideScan image; the screen pauses, and the cursor information window is activated. On a SideScan image, the left/right distance from the vessel to the cursor are shown at the cursor position.

To remove the cursor and the cursor elements from the panel, press the **X** key or select the **Clear cursor** option.

### GoTo cursor

You can navigate to a selected position on the image by positioning the cursor on the panel, then using the **Goto Cursor** option in the menu.

### The Cursor assist function

The cursor assist function allows for fine tuning and precision placement of the cursor without covering details with your finger.

Press and hold your finger on the screen to switch the cursor symbol to a selection circle, appearing above your finger.

Without removing your finger from the screen, drag the selection circle over the desired item to display item information.

When you remove your finger from the screen the cursor reverts to normal cursor operation.



The cursor can be used to measure the distance between the position of two observations on the image.

It is easier to use the measuring function when the image is paused.

1. Position the cursor on the point from where you want to measure the distance
2. Start the measuring function from the menu
3. Position the cursor on the second measuring point
  - A line is drawn between the measuring points, and the distance is listed in the Information window
4. Continue selecting new measuring points if required

You can use the menu to re-position the start point and the end point as long as the measuring function is active.

When you select **Finish measuring** or press the **X** key, the image resumes to normal scrolling.

### Saving waypoints

You can save a waypoint at a selected location by positioning the cursor on the panel, and then selecting the new waypoint option in the menu.

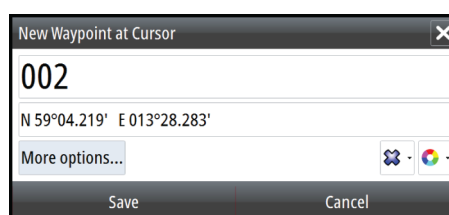

In the Chart and Nav panels, you can save a waypoint at the vessel position, when the cursor is not active, by selecting the new waypoint option in the menu.

If your unit has a **MARK** key, you can press this key to immediately save a waypoint. If the cursor is active, the waypoint is saved at the cursor position. If the cursor is not active, the waypoint is saved at your vessel's position.

## Viewing StructureScan history

Whenever the cursor is active on a StructureScan panel, the scroll bar is shown on the panel. The scroll bar shows the image you are currently viewing in relation to the total StructureScan image history stored.

Depending on the view selected, the scroll bar is on the far right side (SideScan) or at the top of the screen (DownScan).

You can pan the image history by dragging up/down (SideScan) or left/right (DownScan).

To resume normal StructureScan scrolling, press **Clear cursor**.

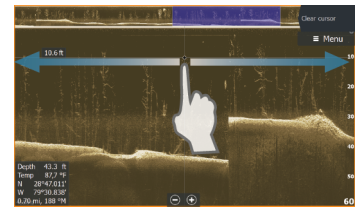
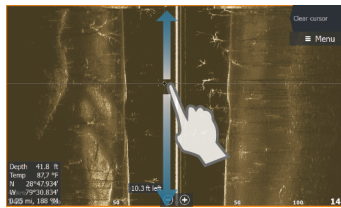

## Setting up the StructureScan image

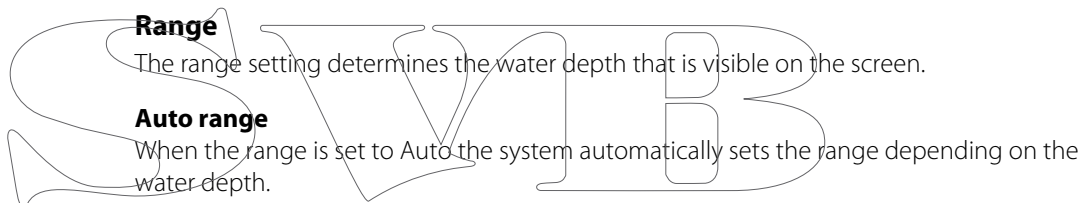

### Range

The range setting determines the water depth that is visible on the screen.

### Auto range

When the range is set to Auto the system automatically sets the range depending on the water depth.

### Preset range levels

You can select between several preset range levels.

### Custom range

This option allows you to manually set both upper and lower range limits.

### StructureScan frequencies

StructureScan supports two frequencies. 455 kHz provides ideal range and image quality in most situations, while 800kHz is used to provide higher detail in shallow water.

### Contrast

The contrast determines the brightness ratio between light and dark areas of the screen. This makes it easier to distinguish object from the background.

To adjust the contrast setting:

1. Select the contrast icon or activate the contrast option in the menu to display the color adjustment bar.
2. Drag the bar or use the rotary knob to set the value.

### Palettes

You can select between several display palettes optimized for a variety of fishing conditions.

### Pausing the StructureScan image

You can pause the StructureScan image, allowing you to examine the structures and other images in more depth and detail.

This function is useful when you need to position a waypoint exactly on the StructureScan image, and if you are using the cursor to measure a distance between 2 elements on the image.

## Advanced StructureScan settings

### TVG

The TVG (Time Variable Gain) option compensates for distance to the object, making echoes from equal sized objects appear with the same size on the echosounder image.

### Flipping the Structure image left/right

If required, the left/right SideScanning images can be flipped to match the corresponding side of your vessel if the transducer has been mounted backward.

### Range Lines

Range lines can be added to the image to make it easier to estimate depth (Downscan) and distance (SideScan).

### Recording StructureScan data

You can record StructureScan data and save the file internally in the NSS evo2 unit, or onto an SD card as described in "*Start Recording echosounder data*" on page 72.

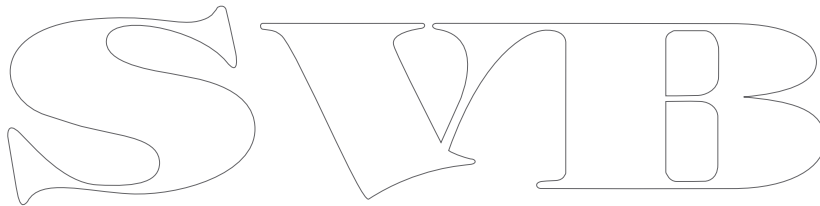

# 11

## StructureMap

The StructureMap feature overlays SideScan images from a StructureScan source on the map. This makes it easier to visualize the underwater environment in relation to your position, and aids in interpreting SideScan images.

### The StructureMap image

The example below shows a chart panel with Structure overlay, combined with a traditional SideScan panel.

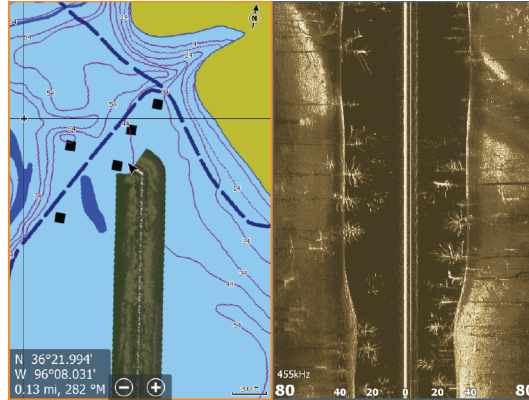

You move around in the chart as usual when you have a Structure overlay:

- zoom the chart and the scanned image by turning the rotary knob, by using the zoom icons, or by pinching or spreading on the screen
  - move the chart to view the scanned image by dragging it in the desired direction
- Pressing the **X** key or selecting the **Clear cursor** option removes the cursor from the panel, and the chart center is positioned at the vessel.

### Activating Structure overlay

1. Turn on Structure overlay from the chart menu
    - The chart menu is increased to show Structure options
    - Structure data starts to appear on the chart screen as soon as Structure overlay is enabled
  2. Select Structure source
    - Live data is default
- **Note:** Structure overlay can also be activated by selecting a saved StructureMap file in the files browser.

### StructureMap sources

Two sources can be used to overlay Structure logs on the charts, but only one can be viewed at a time:

- Live data - Used when StructureScan data is available on the system.
- Saved files - These are recorded StructureScan (\*.sl2) data that are converted to StructureMap (\*.smf) format. Saved \*.smf files can be used even if no StructureScan sources are connected.

#### Live source

When live data is selected, the SideScan imaging history is displayed as a trail behind the vessel icon. The length of this trail varies depending on available memory in the unit and range settings. As the memory fills up, the oldest data is automatically deleted as new data is added. When increasing the search range, the ping speed of the StructureScan transducer is reduced, but the width and the length of the image history is increased.

- **Note:** Live mode does not save any data. If the unit is turned off, all recent data is lost.



### Saved files

When Saved files are selected, the StructureMap file is overlaid on the map based on position information in the file.

If the chart scale is large, the StructureMap area is indicated with a boundary box until the scale is large enough to show Structure details.

Saved mode is used to review and examine StructureMap files, and to position the vessel on specific points of interest on a previous scanned area.

- **Note:** When saved files are used as the source, all StructureMap files found on the SD card and in the system's internal memory are displayed. If there is more than one StructureMap of the same area, the images overlap and clutter the chart. If several logs of the same area are required, the maps should be put on separate SD cards.

### StructureMap tips

- To get a picture of taller structures (a wreck, etc.) — do not drive over it, instead, steer the boat so the structure is on the left or right side of your vessel.
- Do not use Autorange when using StructureScan. Set your structure range to a significantly greater level (two-to-three times) than the water depth to ensure a complete scan and to maximize conversion accuracy.
- Do not overlap history trails when conducting a side-by-side scan of an area.

### Recording StructureScan data

StructureScan data can be recorded from a chart panel with Structure overlay enabled.

StructureScan recordings can also be started from a StructureScan panel.

When StructureScan data is being recorded, there is a flashing red symbol and a message appears periodically at the bottom of the screen.

- **Note:** The message includes information about file size. Keep the size of your logs to 100MB or less to allow for faster file conversion.

The recording is stopped by re-selecting the record function.

### Converting StructureScan data to StructureMap format

A StructureScan log file (.sl2) is converted to StructureMap format (.smf) after recording from the recording dialog, or from the files browser.

You can create standard or high resolution files. High resolution .smf files capture more detail, but take longer to convert and are larger than standard resolution files.

To save disc space it is recommended to remove the StructureScan (\*.sl2) files after conversion.

### Using StructureMap with mapping cards

StructureMap allows you to maintain full chart capability and can be used with embedded cartography as well as Navionics, Insight and other third-party charting cards compatible with the system.

When using StructureMap with mapping cards, copy the StructureMap (.smf) files to the unit's internal memory. We recommend keeping copies of StructureMap files on external mapping cards.

### Structure options

You adjust the StructureMap settings from the Structure options menu. The menu is available when Structure overlay is enabled.

Not all options are available when saved StructureMap files are used as the source. Unavailable options are greyed.

### Range

Sets the search range.

### **Transparency**

Sets the opaqueness of the Structure overlay. With minimum transparency settings, the chart details are almost hidden by the StructureMap overlay.

### **Palette**

Selects Structure palette.

### **Contrast**

Determines the brightness ratio between light and dark areas of the screen.

### **Water column**

Shows/hides the water column in Live mode.

If turned OFF schools of bait fish might not be seen on the SideScan image.

If turned ON the accuracy of the SideScan image on the map might be affected by the water depth.

### **Frequency**

Sets the transducer frequency used by the unit. 800 kHz offers the best resolution, while 455 kHz has greater depth and range coverage.

### **Noise rejection**

Signal interference from bilge pumps, engine vibration and air bubbles can clutter the sonar screen. The noise rejection option filters the signal interference and reduces on-screen clutter.

### **Clear live history**

Clears existing live history data from the screen and begins showing only the most current data.

### **Record data**

Records StructureScan data.

### **Source**

Selects StructureMap source.



# 12

## ForwardScan

ForwardScan sonar is a navigational aid that helps you monitor the underwater environment in front of your vessel while carrying out slow speed maneuvers.

To use the ForwardScan feature you must have a ForwardScan transducer mounted on your vessel. For installation instructions, refer to the ForwardScan transducer installation manual.

The ForwardScan transducer can be connected to a SonarHub and shared over the Ethernet network. You can also connect the ForwardScan transducer to the StructureScan port on your NSS evo2 unit, leaving the sonar port available for a CHIRP transducer.

→ **Note:** If you have both a sonar/CHIRP and a ForwardScan transducer connected directly to a device, you can only view one of them at a time on the device. To view both on the same device simultaneously, one of the transducers must be connected to a SonarHub (or another NSS evo2 shared over the network).

⚠ **Warning:** Do not rely on this equipment as your principle source of navigation or hazard detection.

⚠ **Warning:** Do not use this equipment to gauge depth or other conditions for swimming or diving.

### The ForwardScan image

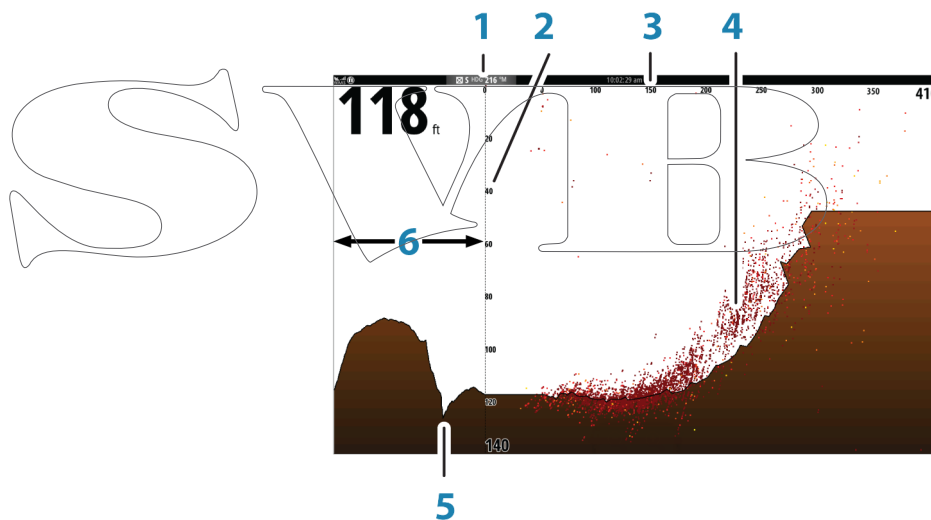

- 1 Transducer location shown as the origin on the page
- 2 Depth range scale and vessel position
- 3 Forward range scale
- 4 Point data
- 5 Bottom
- 6 Depth history

## Setting up the ForwardScan image



### Depth

Controls depth range. Depth range is set to auto mode by default.

### Forward range

Controls the forward looking search range. Maximum Forward range is 91 meters (300 feet).

### Noise Rejection

Filters out signal interference and reduces on-screen clutter.

### Record

Records ForwardScan sonar logs.

### Pause

Pauses forward-looking Echosounder transmissions.

## ForwardScan view options

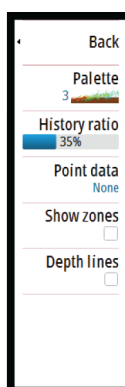

### Palette

Several display palettes are available for a variety of water conditions.

### History ratio

Controls how much Echosounder history is shown behind the boat. The higher the ratio, the more history will be shown.

### Point data

By default, ForwardScan only shows the bottom. Select the Point data menu option to specify to view no sonar data points, all sonar data points, or only points (Objects) in the water column.

### Show zones

Displays warning zones (yellow) and critical zones (red) on the screen. Refer to "Critical forward range and Critical depth" on page 85.

### Depth lines

Displays lines on the screen that make it easier to estimate depth and the underwater objects.

## Heading extension

You can use the heading extension to monitor ForwardScan on the chart panel. Heading extension colors are based on the ForwardScan alarm values.

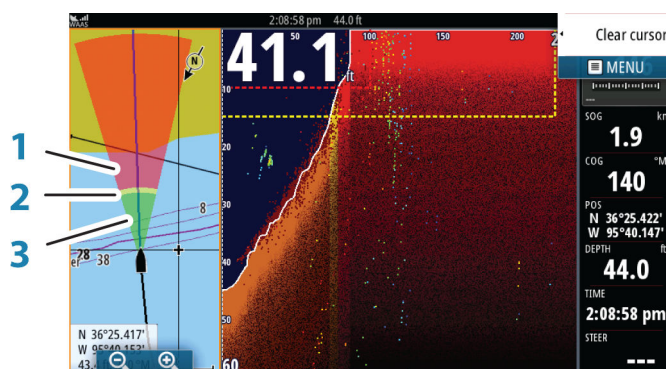

## ForwardScan extension

- 1 Red - Critical
- 2 Yellow - Warning
- 3 Green - Safe

Select ForwardScan in the Chart Settings dialog to view the ForwardScan heading extension on the chart panel.

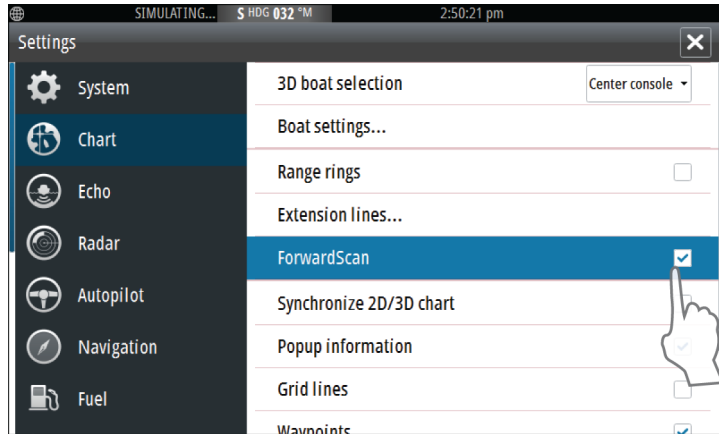

## ForwardScan setup

Specify the setup in the **ForwardScan installation** dialog.

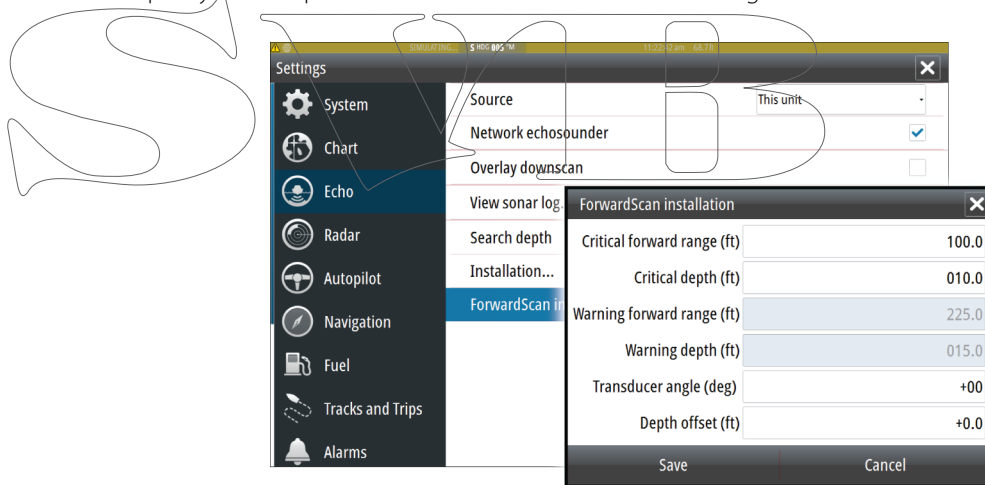

## Critical forward range and Critical depth

Critical Forward Range and Critical Depth are user-selected thresholds that define a critical zone forward of your vessel.

If you travel into water shallow enough to cross into the critical zone, the Critical Zone alarm is activated. You can display the critical warning zones by activating the **Show zones** menu option.

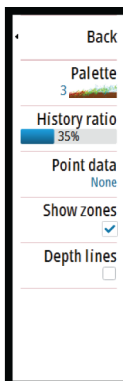

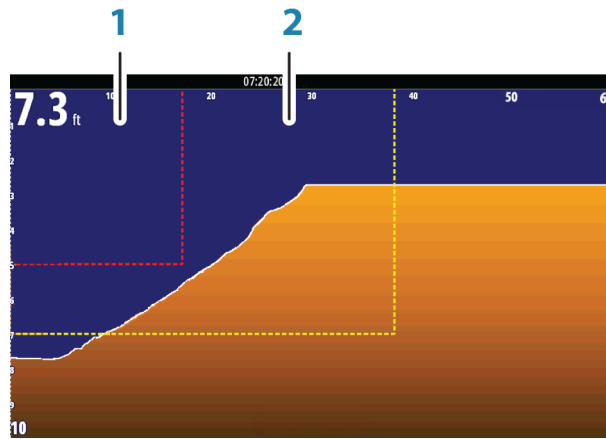

ForwardScan image with Show zones active

- 1 Critical zone
- 2 Warning zone

Warning Forward Range and Warning Depth values are based on the selected Critical Forward Range and Critical Depth values.

→ **Note:** To receive Critical Zone alerts, enable ForwardScan alarm in the Alarm settings dialog. For more information about enabling alarms, refer to Alarms.

### Transducer angle

We recommend installing the transducer vertical to the waterline. In cases where that is not possible, the Transducer Angle setting helps offset the difference between the transducer angle and the waterline.

The angle can be adjusted from 0 (vertical) to 20 degrees.

**Warning:** Adjustments to the transducer angle value should be done with caution. Large variations in the transducer angle value can distort depth data, increasing the risk of striking underwater obstructions.

### Depth offset

This is a value that can be entered on the Echo Installation page to make depth readings relate to any point from the water surface, to the deepest point of the vessel. Below are some typical ways in which the offset is used:

- A) For Depth below Keel: Set the distance from transducer to the bottom of the keel - this should be set as a negative value. For example, -2.0.
- B) For Depth Below Transducer: no offset required.
- C) For Depth Below Surface (waterline): Set the distance from transducer to the surface - this should be set as a positive value. For example, +0.5.

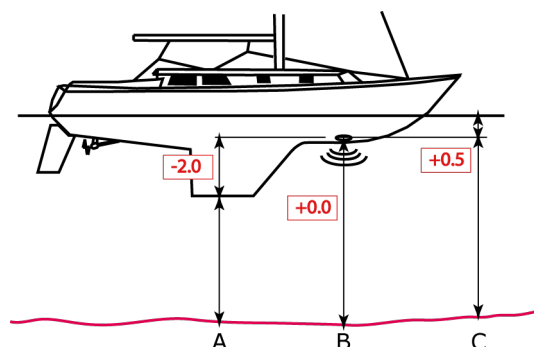

# 13

## Wireless connection

GoFree wireless connectivity gives you the ability to:

- Use a wireless device to remotely view (smartphone and tablet) and control the system (tablet only).
- Access the GoFree Shop.
- Upload your Echosounder logs to create custom maps at Insight Genesis.
- Download software updates
- Connect to third party applications



- **Note:** Maps, charts, software updates, and other data files can be large. Your data provider may charge you based on the amount of data you transfer. If you are unsure contact the service provider for information.

You must connect a WIFI-1 unit to the system to provide wireless functionality.

Installation and wiring of the WIFI-1 unit are described in the separate WIFI-1 Installation Guide. Configuration and setup are described in your system's installation manual.

- **Note:** For security purposes we recommend that you change the administrator password of the WIFI-1 unit.

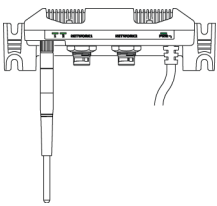

### Connect and disconnect from a wireless hotspot

To connect to a wireless hotspot, select the Wireless option in the System Controls dialog and then select Not Connected. This opens the Wireless Devices dialog. Use this dialog to select the desired hotspot, enter the login information and then select Connect. Connecting to a wireless hotspot changes the wireless mode to **Client mode**. In this mode you can access the GoFree Shop.

To disconnect from a wireless hotspot, select the Wireless option in the System Controls dialog, then select Connected *hotspot\_name*, and then Disconnect. This changes the wireless mode to **Access point mode**. In this mode you can connect a wireless device so that Apps such as GoFree Controller & Viewer can access the vessel's navigation information.

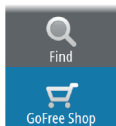
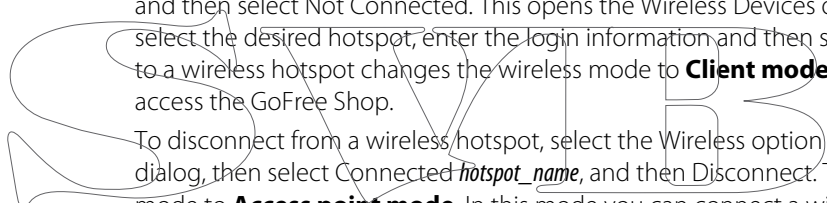

### GoFree Shop

The WIFI-1 must be connected to an external wireless hotspot in order to access the GoFree Shop from the Tools panel.

At the GoFree Shop you can browse, purchase and download compatible content for your system including navigation charts and Insight Genesis Maps. When you log on, the system automatically gives you a notification if a new software version is available for your system. If an update is available, you can download it to a card slot or defer the download until later. If you defer the download until later, the notification is available in the About dialog accessible from the System Settings.



### GoFree Controller & Viewer

The wireless functionality lets you use a wireless device to remotely view (smartphone and tablet) and control the system (tablet only). The system is viewed and controlled from the wireless device by the GoFree Controller & Viewer Apps downloaded from their relevant Application store. When remote control is accepted, the active page is mirrored to the wireless device.

- **Note:** To use smartphones and tablets to view and control the system, wireless functionality must be disconnected from the wireless hotspot (in **Access point mode**).

- **Note:** For safety reasons, Autopilot and CZone functions cannot be controlled from a wireless device.

## Uploading log files to Insight Genesis

To upload a recorded Echosounder log file to Insight Genesis, select the file you want to upload from the Files panel and select the upload to Insight Genesis option.

- **Note:** You must be connected to a wireless hotspot to upload recorded log files to Insight Genesis.
- **Note:** Recorded log files can also be uploaded to Insight Genesis if you have specified **Upload to Insight Genesis** in the Record Echo dialog. For more information, refer to *"Start Recording log data"* on page 72.

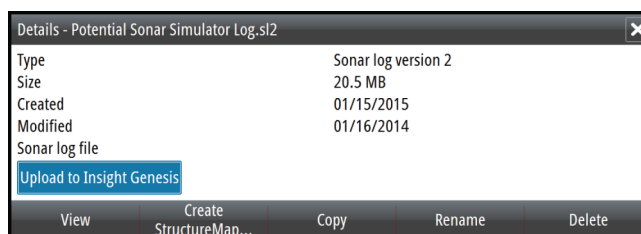

## Wireless settings

Provides configuration and setup options for the wireless functionality.

For more information, refer to the NSS evo2 Installation Manual.

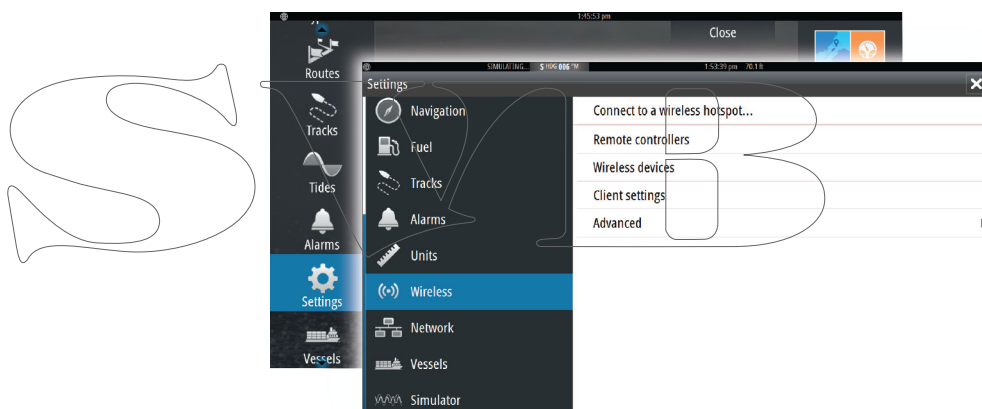

### Connect to a wireless hotspot

Displays the Wireless device dialog that you can use to connect the wireless functionality to a wireless hotspot.

### Remote controllers

When a wireless device (smart phone or tablet) is connected, it should appear in the Remote controllers list. Selecting 'Always allow' means the device can automatically connect without needing a password each time. This menu also allows you to disconnect devices that no longer require access.

### Wireless devices

Shows the internal wireless module and any connected WIFI-1 devices, as well as their IP and channel number. If a WIFI-1 is connected and the system detects the software is out of date, an option to update is also displayed. WIFI-1 updates, when required, are included with the display updates.

Select a device to view additional information about it. 'Network Name' and 'Network Key' can be edited for security, and 'Channel' can be changed if the connection to unit is compromised due to interference. 'Mode' can be changed on WIFI-1 devices only. Restore defaults returns the unit to factory settings.



### **Client settings**

Displays information about the wireless hotspot your unit is connected to or the last one your unit was connected to. You can select the hotspot in the dialog to set it as a hotspot you want to always connect to when in range or you can select to delete it.

### **Advanced**

Initiates the Iperf and DHCP Probe tools that help in fault-finding and setting up the wireless network.

- **Note:** Iperf and DHCP Probe are tools provided for diagnostic purposes by users familiar with network terminology and configuration. Navico is not the original developer of these tools, and does not provide support related to their use.

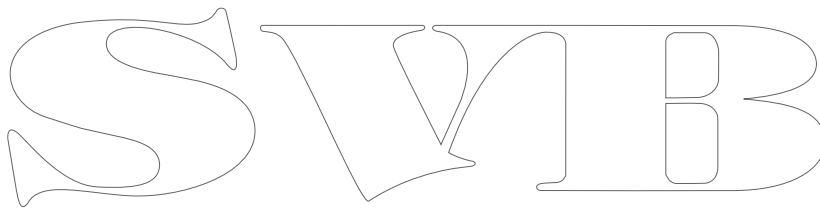
A large, stylized outline logo consisting of the letters 'S', 'V', 'I', and 'B' in a decorative, serif font. The letters are interconnected and have a thin, hollow appearance.

# 14

## AIS

If an NAIS400, an AI50 or a NMEA 2000 VHF that can do AIS (Automatic Identification System) is connected to the NSS evo2, then any targets detected by these devices can be displayed and tracked. You can also see messages and position for DSC transmitting devices within range.

AIS targets can be displayed as overlay on radar and chart images, making this feature an important tool for safe travelling and collision avoidance.

You can set alarms to notify you if an AIS target gets too close or if the target is lost.

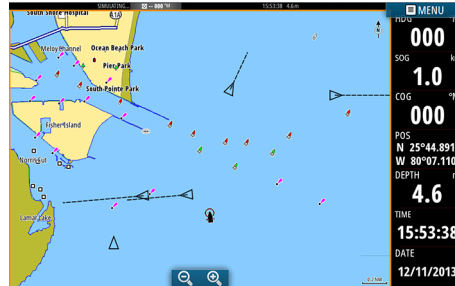

AIS vessels on a chart panel

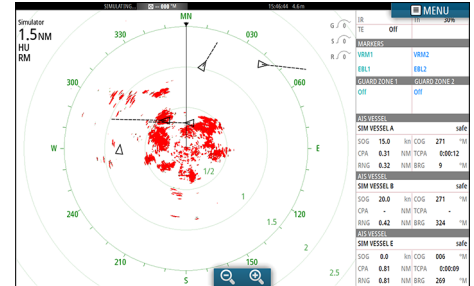

AIS vessels on a radar panel

### AIS target symbols

The system uses the AIS target symbols shown below:

	Sleeping AIS target (not moving or at anchor).
	Moving and safe AIS target with course extension line.
	Dangerous AIS target, illustrated with bold line. A target is defined as dangerous based on the CPA and TCPA settings. Refer to <i>"Defining dangerous vessels"</i> on page 94.
	Lost AIS target. When no signals have been received within a time limit, a target is defined as lost. The target symbol represents the last valid position of the target before the reception of data was lost.
	Selected AIS target, activated by selecting a target symbol. The target returns to the default target symbol when the cursor is removed from the symbol.

### Viewing information about AIS targets

#### Searching for AIS items

You can search for AIS targets by using the **Find** option in the Tools panel.

From a chart panel you can search for AIS targets by using the **Find** option in the menu. If the cursor is active, the system searches for vessels around the cursor position. Without an active cursor, the system searches for vessels around your vessel's position.

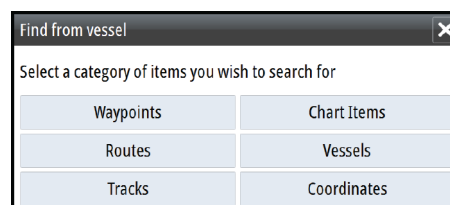

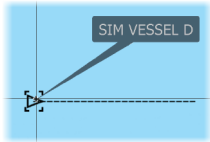

## Viewing information about single AIS targets

When you select an AIS icon on the chart or radar panel the symbol changes to Selected target symbol, and the vessel's name is displayed.

You can display detailed information for a target by selecting the AIS pop-up, or from the menu when the target is selected.



## AIS information on radar panels

The radar data bar includes information on up to 3 AIS targets.

The targets are listed with the closest target on top, and are color coded to indicate target status.

AIS VESSEL			
SIM VESSEL A safe			
SOG	15.0	kn	COG 271 °M
CPA	0.31	NM	TCPA 0:00:12
RNG	0.32	NM	BRG 9 °M
SIM VESSEL B safe			
SOG	20.0	kn	COG 271 °M
CPA	-	NM	TCPA -
RNG	0.42	NM	BRG 324 °M
SIM VESSEL E safe			
SOG	0.0	kn	COG 006 °M
CPA	0.81	NM	TCPA 0:00:09
RNG	0.81	NM	BRG 269 °M

## Calling an AIS vessel

If the system includes a VHF radio supporting DSC (Digital Select Calling) calls over NMEA 2000, you can initiate a DSC call to other vessels from the NSS evo2.

The call option is available in the **AIS Vessel Details** dialog, and in the **Vessel** status dialog activated from the **Tools** panel.

From the **Call** dialog you can change channel or cancel the call. The **Call** dialog is closed when the connection is established.

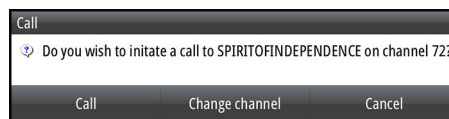

## AIS SART

When an AIS SART (Search and Rescue beacon) is activated, it starts transmitting its position and identification data. This data is received by your AIS device.

If your AIS receiver is not compliant with AIS SART, it interprets the received AIS SART data as a signal from a standard AIS transmitter. An icon is positioned on the chart, but this icon is an AIS vessel icon.

If your AIS receiver is compliant with AIS SART, the following takes place when AIS SART data is received:

- An AIS SART icon is located on the chart in the position received from the AIS SART
- An alarm message is displayed

If you have enabled the siren, the alarm message is followed by an audible alarm.

→ **Note:** The icon is green if the received AIS SART data is a test and not an active message.



## AIS SART alarm message

When data is received from an AIS SART, an alarm message is displayed. This message includes the AIS SART's unique MMSI number, and its position, distance, and bearing from your vessel.

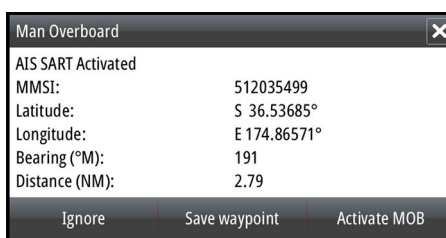

You have three options:

- Ignore the alarm
  - The alarm is muted and the message closed. The alarm does not reappear
- **Note:** If you ignore the alarm, the AIS SART icon remains visible on your chart, and the AIS SART remains in the Vessels list.
- Save the waypoint
  - The waypoint is saved to your waypoint list. This waypoint name is prefixed with MOB AIS SART - followed by the unique MMSI number of the SART. For example, MOB AIS SART - 12345678.
- Activate the MOB function
  - The display switches to a zoomed chart panel, centered on the AIS SART position
  - The system creates an active route to the AIS SART position

→ **Note:** If the MOB function is already active, this will be terminated and replaced by the new route towards the AIS SART position!

→ **Note:** If the AIS stops receiving the AIS SART message, the AIS SART remains in the Vessels list for 10 minutes after it receives the last signal.

If you select the AIS SART icon on the chart panel, then you can see the AIS MOB details.

## Vessel alarms

You can define several alarms to alert you if a target shows up within predefined range limits, or if a previously identified target is lost.

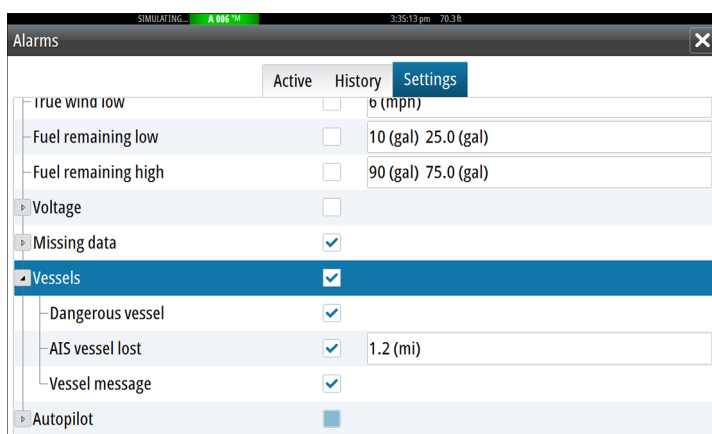
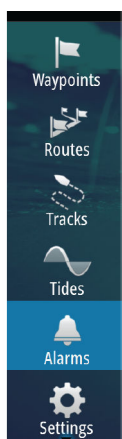

### Dangerous vessel

Controls whether an alarm will be activated when a vessel comes within the predefined CPA or TCPA. Refer to "Defining dangerous vessels" on page 94.

### AIS vessel lost

Sets the range for lost vessels. If a vessel is lost within the set range, an alarm occurs.

- **Note:** The check box controls whether the alarm pop-up box is displayed and if the siren goes on. The CPA and TCPA define when a vessel is dangerous regardless of the enabled or disabled state.

### Vessel message

Controls whether an alarm will be activated when a message is received from an AIS target.

## Vessel settings

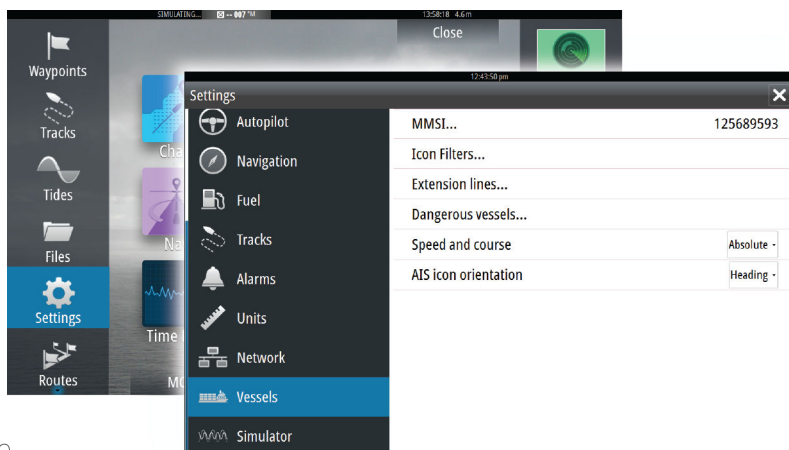

### Your vessel's MMSI number

You need to have your own MMSI (Maritime Mobile Service Identity) number entered in the system to receive addressed messages from AIS and DSC vessels.

It is also important to have the MMSI number entered to avoid seeing your own vessel as an AIS target on the chart.

- **Note:** The Vessel message option in the alarm settings must be toggled on for any MMSI message to be displayed.

### Icon filters

By default, all targets are shown on the panel if an AIS device is connected to the system.

You can select not to show any targets, or to filter the icons based on security settings, distance, and vessel speed.

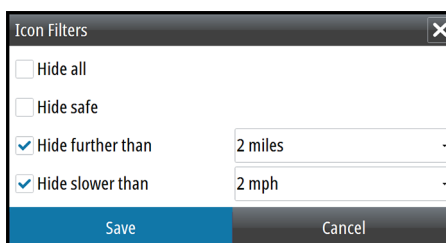

### Extension lines

The length of the extension lines for your vessel and for other vessels can be set by the user.

- A: Heading
- B: Course Over Ground (COG)

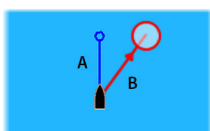

The length of the extension lines is either set as a fixed distance, or to indicate the distance the vessel will move in the selected time period. If no options are turned on for **This vessel** then no extension lines are shown for your vessel.

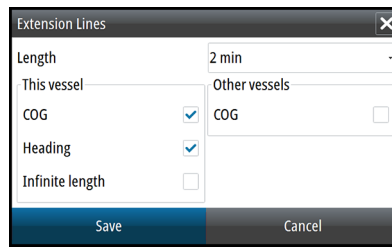

Your own vessel heading information is read from the active heading sensor, and COG information is received from the active GPS.

For other vessels COG data is included in the message received from the AIS system.

### Defining dangerous vessels

You can define an invisible guard zone around your vessel. When a target comes within this distance, the symbol changes to the “dangerous” target symbol. An alarm is triggered if activated in the Alarm settings panel.

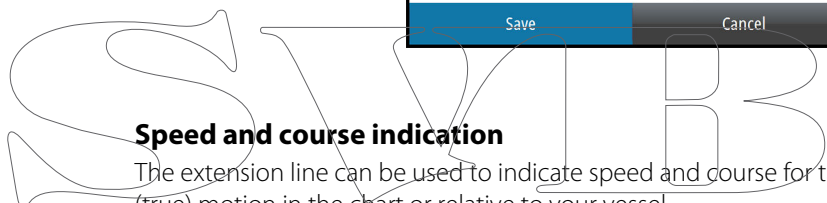
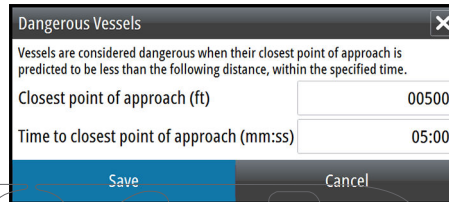

### Speed and course indication

The extension line can be used to indicate speed and course for targets, either as absolute (true) motion in the chart or relative to your vessel.

A different line style is used on the extension lines to indicate motion, as shown below.

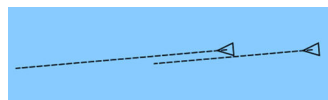

*AIS vessels shown with Absolute motion*



*AIS vessels shown with Relative motion*

### AIS icon orientation

Sets the orientation of the AIS icon, either based on heading or COG information.

# 15

## Instrument panels

The Instruments panels consist of multiple gauges - analog, digital and bar - that can be customized to display selected data. The Instruments panel displays data on dashboards, and you can define up to ten dashboards within the Instruments panel.

→ **Note:** To include fuel/engine information, engine and tank information has to be configured from the Settings panel.

### Dashboards

A set of dashboard styles are predefined to display vessel, navigation, and angler information. You switch between the panel's dashboards by selecting the left and right arrow buttons on the panel. You can also select the dashboard from the menu.



Vessel dashboard

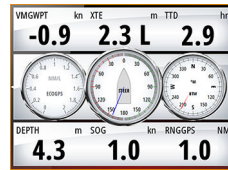

Navigation dashboard

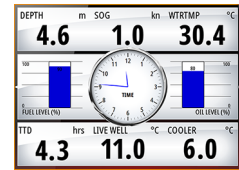

Angler dashboard

→ **Note:** Additional dashboards can be activated from the menu if other systems (e.g. CZone) are present on the network.

### Customizing the Instruments panel

You can customize the Instruments panel by changing the data for each of the gauges in the dashboard, by changing the dashboard layout, and by adding new dashboards. You can also set limits for analog gauges.

All edit options are available from the Instruments panel menu.

Available editing options depends on which data sources are connected to your system.

#### Edit a dashboard

Activate the dashboard you want to edit, then:

1. Activate the menu.
2. Select the edit option.
3. Select the gauge you want to change. Selected gauge is indicated with a colored background.
4. Select information to be displayed, configure limits, and eventually change the source for the information.
5. Save your changes by selecting the save option in the menu.

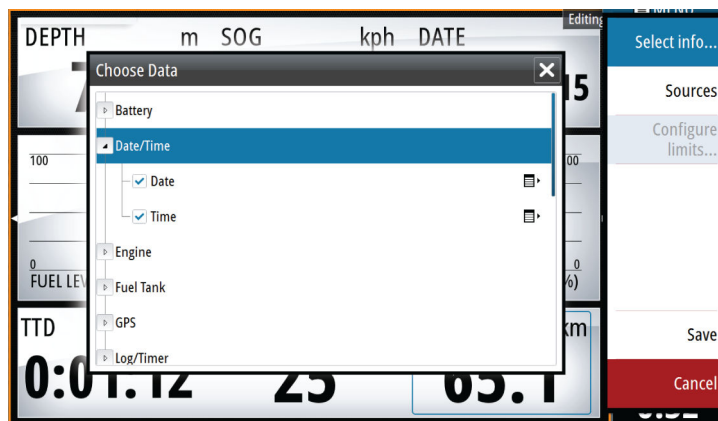
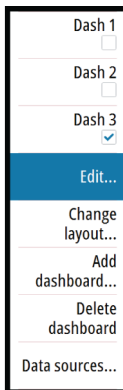

# 16

## Audio

If a SonicHub server or a FUSION marine entertainment system is connected to the NMEA 2000 network, you can use the NSS evo2 to control and customize the audio system on your vessel.

When connected to a WM-3 Satellite module with an active subscription, you can include SiriusXM products on your system. You can also connect a SiriusXM radio to a FUSION system. Sirius audio and weather service covers inland U.S. waters and coastal areas into the Atlantic and Pacific oceans, Gulf of Mexico, and the Caribbean Sea. The SiriusXM products received vary depending on your selected subscription package. For more information refer to [www.siriusXM.com](http://www.siriusXM.com).

Before you can start using your audio equipment, it must be installed according to the NSS evo2 Installation manual and to the documentation included with the audio device.

### Enabling audio

A compatible audio device connected to the NMEA 2000 network should automatically be identified by the system. If not, enable the feature from the **Advanced Settings** dialog.

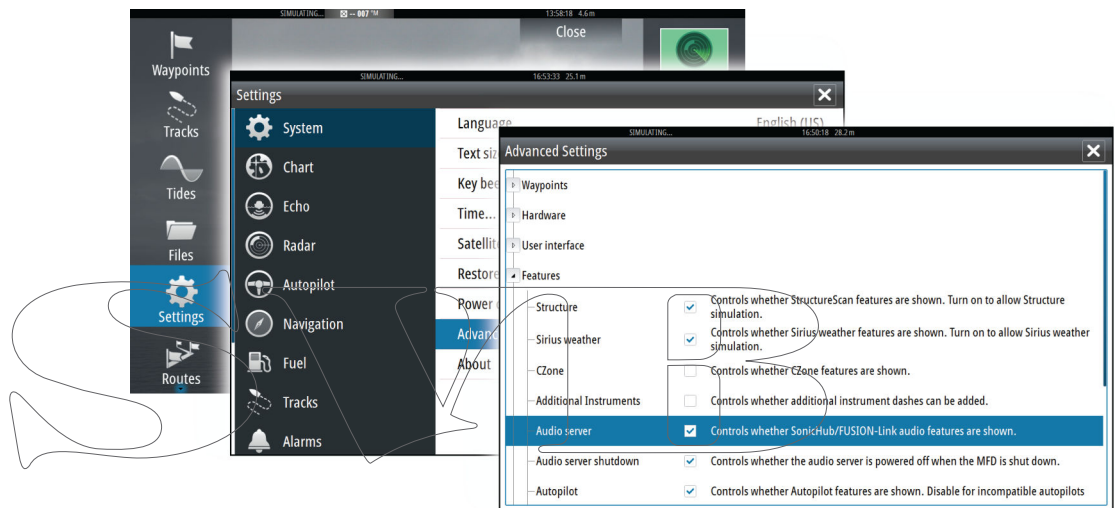

### The Audio panel

You activate the audio panel by activating the audio tile in the Instrument bar.







The control buttons, tools and options vary from one audio source to another as described later in this chapter.









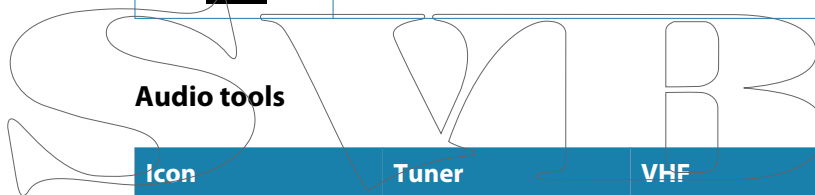

- 1 Audio source
- 2 Audio control buttons
- 3 Audio tile
- 4 Audio tools

### Audio control buttons

Icon	Tuner	VHF	DVD	Playback
 iPod	Select to display the list of available sources			
	Select to select previous/next frequency Press and hold to tune in a channel		Select to rewind/play fast forward	Select to select previous/next track
	Select to select next/previous favorite channel		N/A	N/A
	N/A	N/A	Select to start	
	N/A	N/A	Select to pause playback	
	Select to display the volume slider			



### Audio tools

Icon	Tuner	VHF	Playback
	Signal strength	N/A	N/A
	N/A	N/A	Select to toggle on/off repeat function. The icon is colored when the function is active.
	N/A	N/A	Select to toggle on/off shuffle mode. The icon is colored when the function is active.
	Select to display menus used for setting up zones and master control		
	Select to display the favorite stations for the tuner	Select to display the favorite channels for the VHF	Select to display the native menu for active source
	Select to display optional settings for active source		

## Setting up the audio system

## The speakers

### Speaker zones

The NSS evo2 can be set up to control different audio zones. The number of zones depends on the audio server connected to your system.

You can adjust balance, volume and volume limit settings individually for each zone. Adjustments to the bass and tremble settings will alter all zones.

### Master volume control

By default the volume for all speaker zones are adjusted when you adjust the volume. You can define which zones will be altered when you increase/decrease the volume.

### Selecting tuner region

Before playing FM or AM radio, and using a VHF radio, you must select the appropriate region for your location.

### Detaching Sirius from the AUX source

If a Sirius radio is connected to the FUSION radio/server, the AUX source is automatically attached to the Sirius feed. **Sirius** then appears in the source list when the FUSION server is active.

To use the AUX source for a different device, the Sirius must be detached from the AUX source.

→ **Note:** To use SiriusXM, an optional SiriusXM tuner must be connected to the FUSION server.

## Operating the audio system

1. Select the Audio tile in the Instrument bar to activate the Audio overlay
2. Select the options icon and then select the audio server
3. Select the source icon and then select the audio source
  - Number of sources depends on the active audio server
4. Use the panel buttons to control your audio system

For an overview of audio control buttons and tools, refer to "*Audio control buttons*" on page 97 and "*Audio Tools*" on page 97.

For available options, refer to the documentation following your audio equipment.

## Favorite channels

When a tuner or VHF channel is tuned in, you can add the channel to your favorite list. The favorite channels can be viewed, selected and deleted from within the Favorite list.

You page through favorite channels by using the up/down audio panel buttons.

## Sirius radio (North America only)

### Channels list

The channels list displays all available Sirius channels, whether or not you have a subscription for the channel.

### Favorites list

You can create a list of your favorite Sirius channels from within the channels list. You cannot add unsubscribed channels.

### Locking channels

You can lock selected Sirius channels from being broadcasted. A 4-digit-code must be entered to lock channels and the same code entered to unlock the channels.

# 17

## Weather





The NSS evo2 includes weather functionality that allows the user to view forecast data overlaid on the chart. This helps gaining a clear understanding of the weather conditions that are likely to appear.

The system supports weather data in GRIB format, available for download from various weather service suppliers. The system also supports weather data from SIRIUS Marine Weather Service. This service is available only in North America.

### Wind barbs

The rotation of the wind barbs indicate the relative wind direction, with the tail showing the direction the wind is coming from. In the graphics below, the wind comes from the northwest.

Wind speed is indicated by a combination of small and large barbs at the end of the wind tail.

	Zero knots / Indeterminate wind direction
	Small barb = 5 knots
	Large barb = 10 knots
	Arrow barb = 50 knots

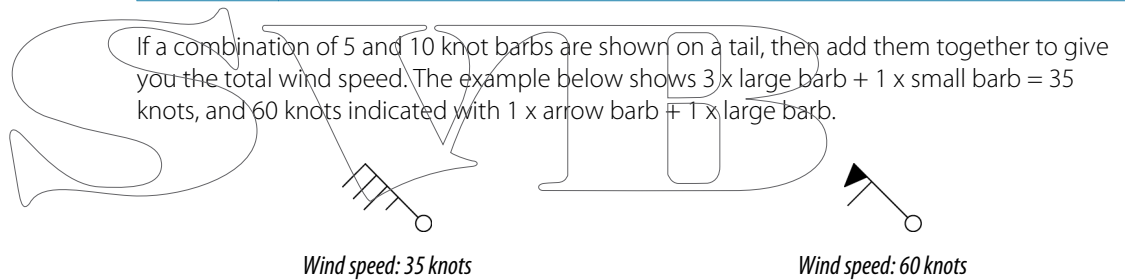

### Showing weather details

If pop-up is enabled, you can select a weather icon to display the identity of the observation. If you select the pop-up, detailed information about the observation is displayed. You can also display the detailed information from the menu when the weather icon is selected.

### GRIB weather

A GRIB file contains forecast information for a set number of days. It is possible to animate the weather data, which shows how weather systems are developing.

#### Importing GRIB data

The downloaded GRIB data must be imported into memory before it can be used. The file can be imported from any location that can be seen in the file explorer.

- **Note:** GRIB data that is imported from an SD card is not saved in the NSS evo2. The data is lost when new GRIB data is imported.

Select the GRIB file to import the data.

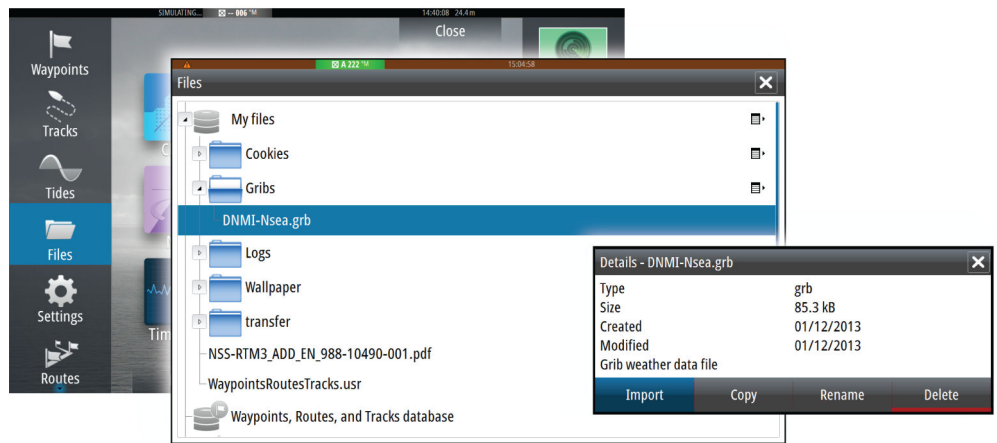

### The GRIB weather display

Imported GRIB weather data can be displayed as an overlay on your chart panel.

When the GRIB weather overlay is selected, the chart menu increases to show GRIB weather options. From this menu you can select which weather symbols you want to display, set the distance between the barbs, and adjust the opaqueness of the weather symbols.

From this menu you can also animate the weather forecast as described later in this chapter.

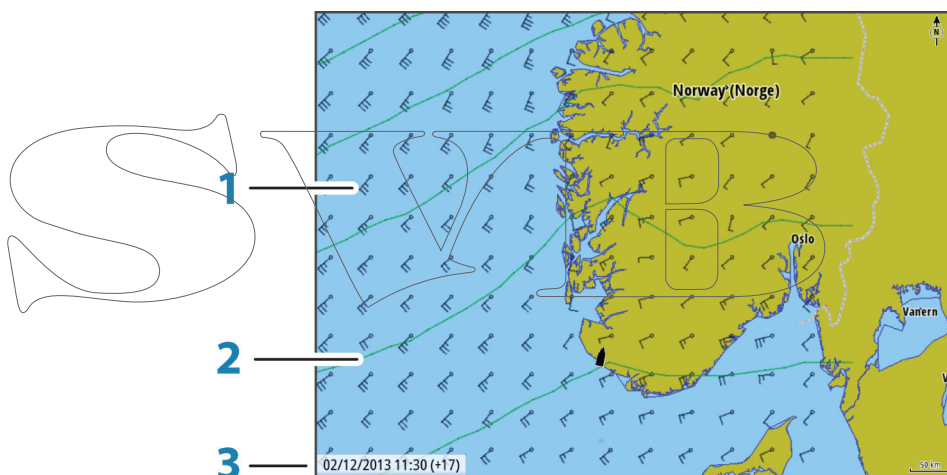

- 1 Wind barbs
- 2 Pressure contours
- 3 GRIB information window

### GRIB information window

The GRIB information window shows the date and time for the GRIB weather forecast, and the selected forecast time in brackets. A negative value in the brackets indicates historic weather data.

If you select a position on the chart, the information window expands to include weather details for the selected position.

### Animating GRIB weather forecast

The GRIB data contains forecast information for a set number of days. It is possible to animate the weather data and to show the predicted forecast for a specific time and date. The time scales vary depending on the file you are using.

The time shift is shown in brackets in the GRIB information window. The time is relative to the current time as provided by a GPS device connected to the system.

Select time and animation speed from the menu.

## SiriusXM weather

When connected to a Navico Weather module, you can subscribe and include Sirius audio and Sirius Marine Weather Service on your system (North America only).

Sirius audio and weather service covers inland U.S. waters and coastal areas into the Atlantic and Pacific oceans, Gulf of Mexico and the Caribbean Sea.

The audio and weather products received vary depending on your selected subscription package. For more information refer to [www.siriusxm.com/marineweather](http://www.siriusxm.com/marineweather)

## Sirius status panel

When the weather module is connected to the system, you get access to the Sirius status panel.

The status panel shows signal strength is indicated as 1/3 (weak), 2/3 (good) or 3/3 (preferred). It also includes antenna status, service level, and the electronic serial number for the weather module.

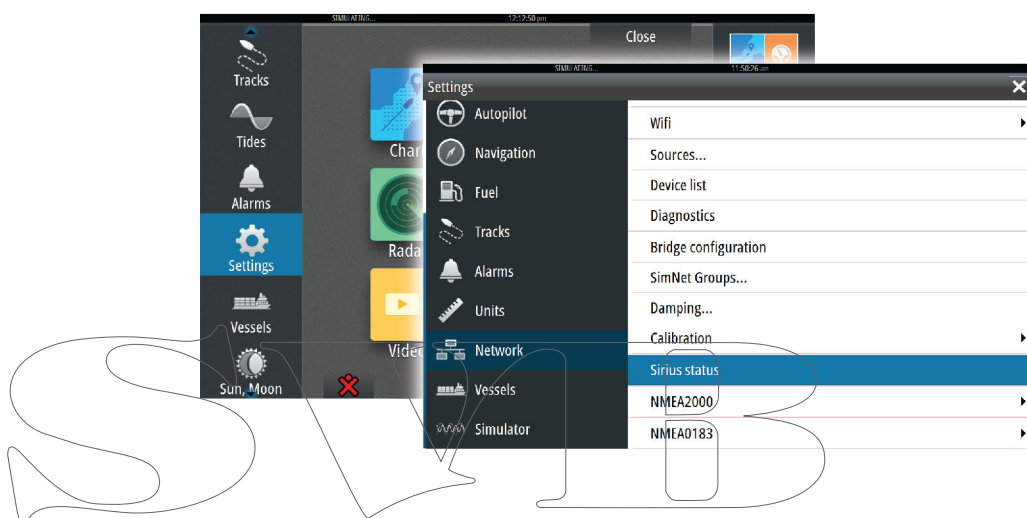

## Sirius weather display

Sirius weather can be displayed as an overlay on your chart panel.

When weather overlay is selected, the chart menu increases to show the available weather options.

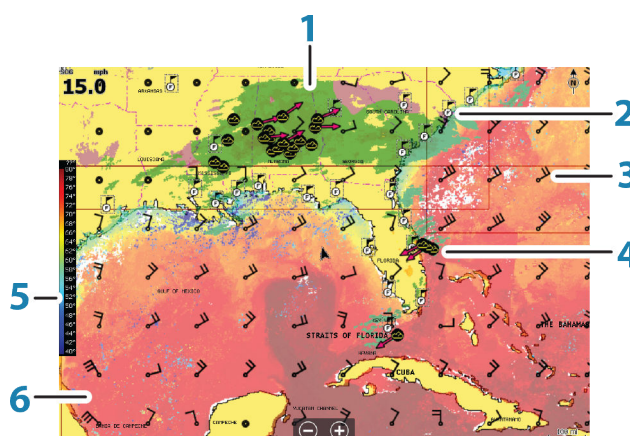

- 1 Precipitation color shading
- 2 City forecast icon
- 3 Wind barb
- 4 Storm icon

- 5 SST color bar
- 6 SST color shading

Use the Sirius weather option menu to select which weather symbology that should be displayed and how they should appear on the chart panel.

### Sirius view options

#### Precipitation

Shades of color are used to show precipitation type and intensity. The darkest color indicates the highest intensity.

Rain	From light green (light rain) - yellow - orange - to dark red (heavy rain)
Snow	Blue
Mixed	Pink

#### Sea Surface Temperature (SST)

You can show the sea surface temperature as color shading or as text.

When color coding is selected, the SST color bar is shown on the left side of the display.

You define how the color codes are used to identify sea surface temperature. See "*Adjusting color codes*" on page 103.









#### Wave indication

Colors are used to indicate forecasted wave height. The highest waves are dark red, while the lowest are blue.

You can define how the color codes are used to identify the wave height. Refer to "*Adjusting color codes*" on page 103.

#### Weather icons

Several weather icons are available to show current or predicted weather conditions. You can select an icon to display detailed weather information.

	City forecast
	Surface observation
	Tropical storm tracking; past (grey) - present (red) - future (yellow)
	Hurricane (category 1-5) tracking; past (grey) - present (red) - future (yellow)
	Tropical disturbance/depression tracking; past (grey) - present (red) - future (yellow)
	Storm attributes
	Lightning
	Watch box location and warning
	Marine zone location

#### Marine zones

Sirius™ service includes access to weather reports for all U.S. Marine Zones, with the exception of the high seas zones.

You can setup the system to read the forecast for a selected area.

Select the selected zone, and use the menu to confirm your selection.

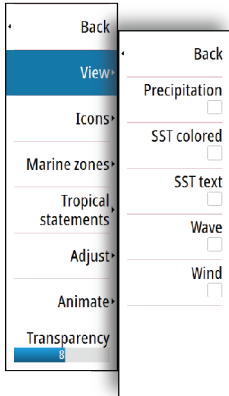

## Tropical statements

You can read tropical statements including information about tropical weather conditions. These statements are available for the entire Atlantic and the Eastern Pacific.

## Adjusting color codes

You can define the sea surface temperature range and wave height color coding.

The temperature above warm and below cool values is displayed as progressively darker red and darker blue.

Waves higher than the maximum value are indicated with progressively darker red. Waves lower than the minimum value are not color coded.

## Animating Sirius weather graphics

The NSS evo2 records the weather information you have turned on, and this information can be used to animate past or future weather conditions. The amount of information available in the system depends on the amount of weather activity; the more complex it is, the less time that is available for animation.

You can animate the past or the future, depending on which weather view you have turned on:

- With precipitation overlay, you can animate for the past and only assume weather conditions in the immediate future.
- With colored wave height overlay, you can animate the future (the predictions).  
When activated, the time for the current graphic animation is displayed in the lower left corner of the chart panel.

## Weather alarms

You can setup lightning or storm alarms to occur when the conditions are within a certain range of your vessel.

You can also set up an alarm as a severe weather forecast alarm issued for your chosen marine zone.

A watchbox is defined by the National Weather Service. When the alarm for watchbox is turned on, an alarm occurs when your vessel is entering or inside a watchbox.

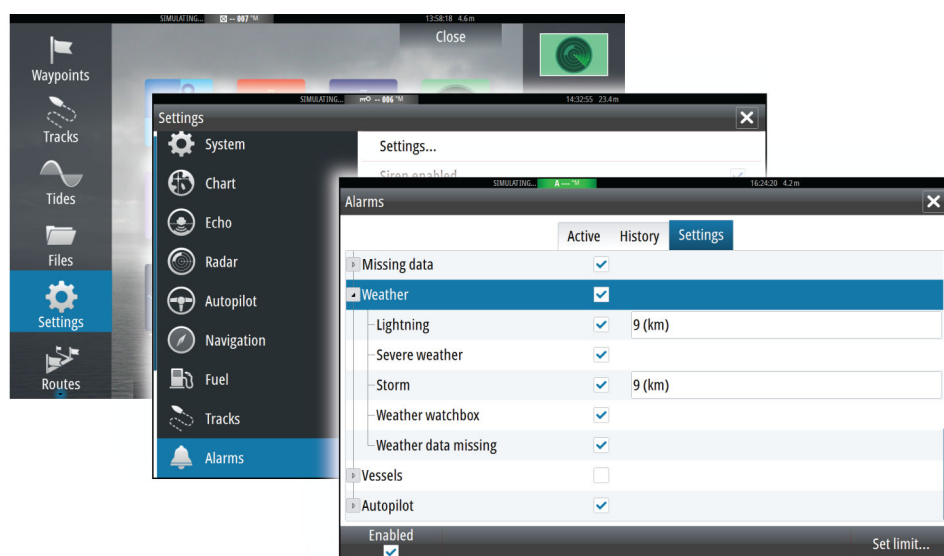
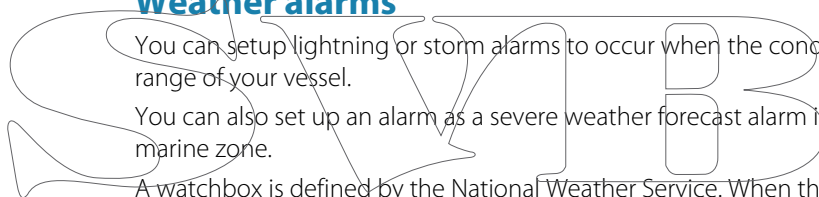
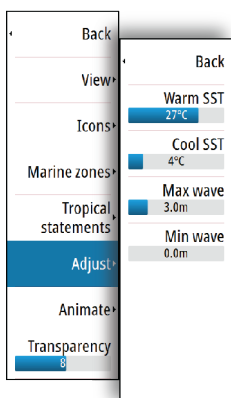

# 18

## Video

The video function allows you to view videos or camera sources on your system.

→ **Note:** The video images are not shared from the Ethernet network. You can only view the video on the unit connected to the video source.

If a FLIR camera is available on the Ethernet network, you can display the video and control the camera from the system.

For information about how to connect the camera, see the separate NSS evo2 Installation manual.

### The Video panel

A video panel can be set up as a single panel, or as one of the panels on a multiple panel page.

The video image is proportionally scaled to fit into the video panel. Areas not covered by the image are colored black.

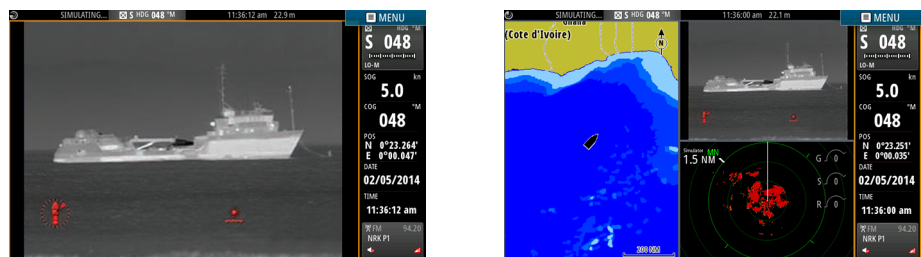

### Setting up the video panel

#### Video source

NSS evo2 supports two video input channels. You can select to view one channel only, or to cycle the image between available video cameras.

The cycle period can be set from 5 to 120 seconds.

#### Video standard

NSS evo2 supports NTSC and PAL video. Check the local video standard or the standard of your cameras.

#### Adjusting the video image

You can optimize the video display by adjusting the video image settings. The settings are adjusted individually for each video source. Default for all settings: 50%.

### FLIR camera control

When the connection is established to a FLIR camera, the menu changes to include access to FLIR camera controls.

→ **Note:** You can take over camera control from any NSS evo2 connected to the Ethernet network.

#### Establishing connection with the FLIR video camera

When a video panel is active, the NSS evo2 automatically recognizes a FLIR camera if it is available on the network.

→ **Note:** When there is a DHCP server present on the Ethernet network, the FLIR camera needs to be configured and set to have a Static IP Address before the connection can be established. For instructions on how to configure your specific FLIR camera model, refer to FLIR documentation.

→ **Note:** Only one FLIR camera can be connected to the Ethernet network.

When you activate a video panel, the system starts searching the network for a FLIR camera.

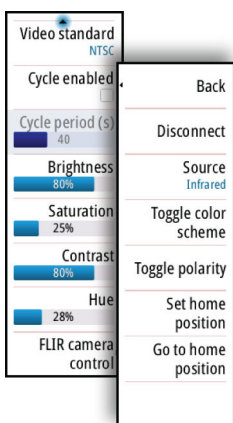



Lost connections are indicated by a panel key. Select this key to reestablish the connection. When the connection is established the menu changes to include access to FLIR camera control.

→ **Note:** You can take over camera control from any NSS evo2 unit connected to the Ethernet network.

### **Panning and tilting the FLIR camera**

When the connection to the FLIR camera is established, pan and tilt panel buttons appear on the video panel. The left and right arrow buttons control the camera's pan. The up and down arrow buttons tilt the camera.

Select one of the arrow buttons on the panel to control the camera. The camera continues to move for as long as you press the button.

### **Zooming the FLIR video image**

You zoom the video image by using the zoom panel buttons.

There are two zoom options available, depending upon your selected FLIR camera source option:

- **Digital zoom**  
Only available when the camera is in Infrared mode. In this mode, the zoom is represented in levels (0, 2 and 4 times zoom). Each press on a zoom button increments or decrements the zoom level.
- **Optical zoom**  
Available in daylight mode. In this mode, the camera continues to zoom for as long as you press a zoom panel button.

### **The FLIR camera source options**

The FLIR camera includes both daylight and infrared video sources.

When the infrared source is selected, the following options are available:

- **Toggle color scheme**  
Cycles through FLIR's video output color scheme. Each of these schemes maps a different color to a different temperature.
- **Toggle polarity**  
Inverts the color scheme. For example, instead of: White = Hot and Black = Cold, it becomes Black = Hot and White = Cold.

### **The FLIR camera's home position**

You can set the current pan and tilt position as the camera's home position.

You can later quickly return to this camera position.

# 19

## Time plots

The NSS evo2 can present data history in different plots. The plots can be displayed in full page, or combined with other panels.

### The Time plot panel

The Time plot panel consists of two predefined layouts. You switch between the layouts by selecting the left and right panel arrows. You can also select the layout from the menu.

You can select which data to present on a time plot panel, and you can define the time range for each plot.

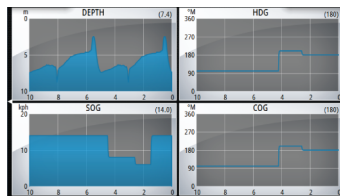

Layout 1

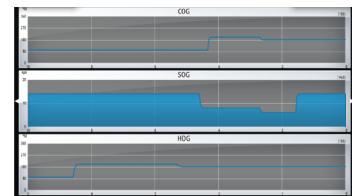

Layout 2

### Missing data

If the data is unavailable, the relevant plot turns into a dashed line and flattens out at the point the data was lost. When the data becomes available again, a dashed line joins up the two points showing an average trend line bridging the missing data.

### Selecting data

Each data field can be changed to show the preferred data type and the time range.

1. Select the edit option from the menu
2. Activate the field you want to edit
3. Change the information type and eventually the range
4. Save your changes

The data available for the Time plots are by default the sources used by the system. If more than one data source is available for a data type you can select to show alternative data source in the Time plot. You change the data type by using the data source option in the menu.

# 20

## Alarms

### Alarm system

The system continuously checks for dangerous situations and system faults while the system is running. When an alarm situation occurs, an alarm message pops up on the screen.

An alarm icon is displayed in the status bar, and the status bar pulses the color of the alarm.

If you have enabled the siren, the alarm message is followed by an audible alarm, and the switch for external alarm becomes active.

The alarm is recorded in the alarm listing so that you can see the details and take the appropriate corrective action.

### Type of messages

The messages are classified according to how the reported situation affects your vessel. The following color codes are used:

Color	Importance
Red	Critical
Orange	Important
Yellow	Standard
Blue	Warning
Green	Light warning

### Single alarms

A single alarm is displayed with the name of the alarm as the title, and with details for the alarm.

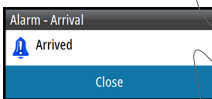

### Multiple alarms

If more than one alarm is activated simultaneously, then the alarm message displays a list of up to 3 alarms. The alarms are listed in the order they occur with the alarm activated first at the top. The remaining alarms are available in the Alarms dialog.

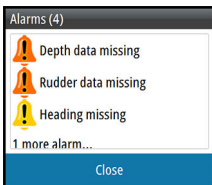

### Acknowledging a message

The following options are available in the alarm dialog for acknowledging a message:

- **Close**  
Sets the alarm state to acknowledged, meaning that you are aware of the alarm condition. The siren / buzzer stops and the alarm dialog is removed. However, the alarm remains active in the alarm listing until the reason for the alarm has been removed.
- **Disable**  
Disables the current alarm setting. The alarm does not show again unless you turn it back on in the Alarms dialog. There is no time-out on the alarm message or siren. They remain until you acknowledge the alarm or until the reason for the alarm is removed.

## Alarms dialog

All alarms are setup in the Alarms Settings dialog.

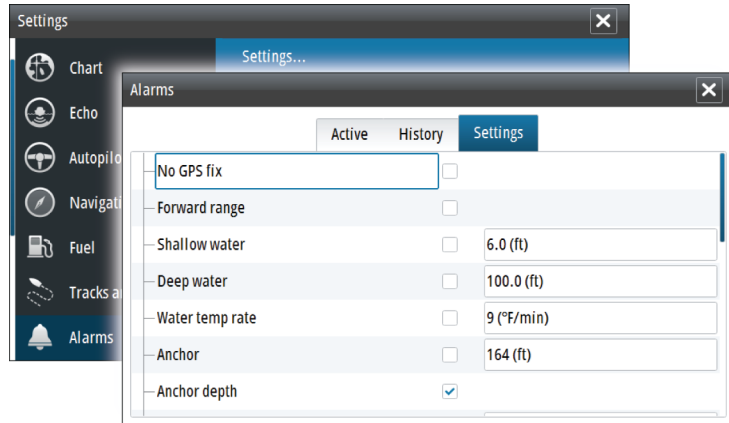
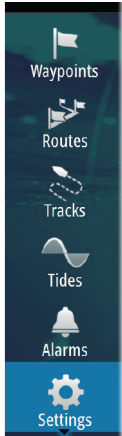

The alarm dialogs can also be activated from the Tools panel. The alarm dialogs include information about active alarms and alarm history.

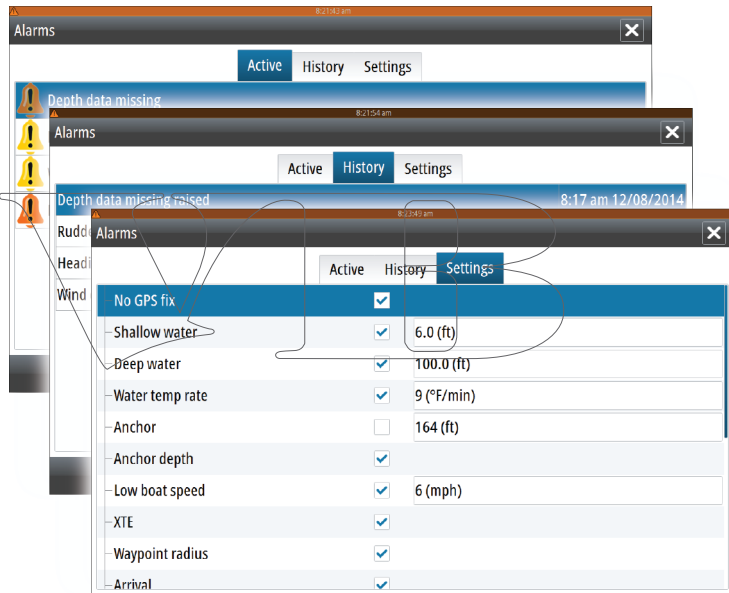
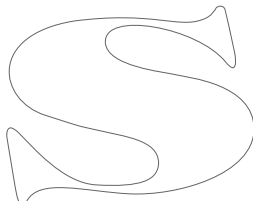
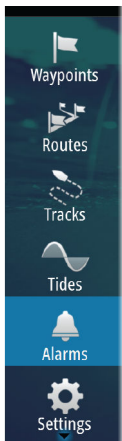

# 21

## Tools

By default, the Tools panel includes icons used for accessing options and tools that are not specific to any panel.

When external equipment is integrated to the NSS evo2, new icons might be added to the Tools panel. These icons are used for accessing the external equipment's features.



### Waypoints/routes/tracks

List of waypoints, routes, and tracks with details.

Select the waypoint, route, or track you wish to edit or delete.

### Tides

Displays tide information for the tide station nearest to your vessel.

Select the arrow panel buttons to change the date, or select the date field to access the calendar function.

Available tide stations can be selected from the menu.

### Alarms

#### Active alarms

List of active alarms.

#### Alarm history

List of all alarms with time stamp.

#### Alarm settings

List of all available alarm options in the system, with current settings.

### Settings

Provides access to application and system settings.

### Vessels

#### Status listing

List of all AIS, MARPA, and DSC vessels with available information.

#### Message listing

List of all messages received from other AIS vessels with time stamp.

### Sun, Moon

Displays sunrise, sunset, moonrise and moonset for a position based on entered date and the position's latitude/longitude.

### Trip calculator

#### Trip 1 / Trip 2

Displays voyage and engine information, with reset option for all data fields.

#### Today

Displays voyage and engine information for current date. All data fields are automatically reset when the date changes.

### Files

File management system for Files, Waypoints, Routes, Tracks, and Settings.

## Find

Search function for chart items (waypoints, routes, tracks, etc.).

A large, hollow outline of the letters 'SWIB' in a serif font. The letters are white with a thin black outline, set against a white background.

# 22

## Simulator

The simulation feature lets you see how the unit works in a stationary position and without being connected to the Echosounder, Radar, GPS, etc.

Use the simulator to become familiar with your unit before using it on the water.

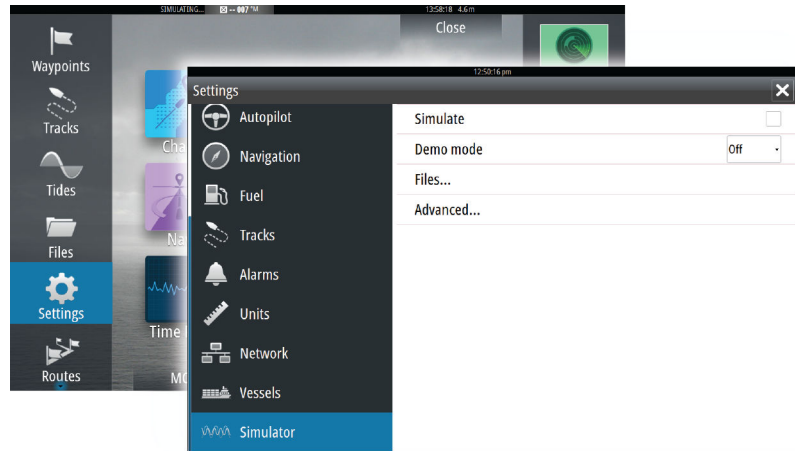

The status bar indicates if the simulator is toggled on.

### Demo mode

In this mode the unit automatically runs through the main features of the product; it changes pages automatically, adjusts settings, opens menus, and so on.

If you tap on a touchscreen or press a key when demo mode is running, the demonstration pauses. After a time-out period, demo mode resumes and any changed settings are restored to default.

→ **Note:** Demo mode is designed for retail/showroom demonstrations.

### Simulator source files

You can select which data files are used by the simulator. A set of source files is included in your system, and you can import files by using a card inserted into the card reader. You can also use your own recorded files in the simulator.

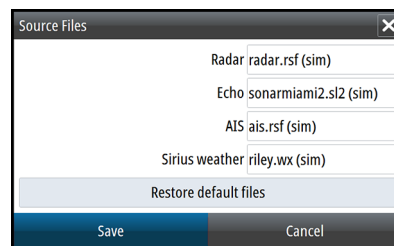

### Advanced simulator settings

The Advanced simulator settings allows for manually controlling the simulator.

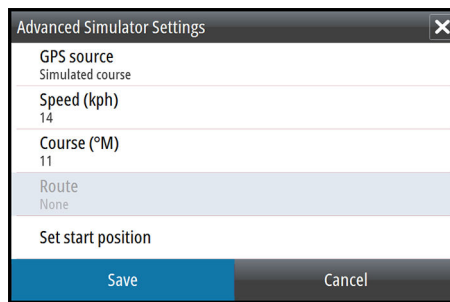

### **GPS source**

Selects where the GPS data is generated from.

### **Speed, Course and Route**

Used for manually entering values when GPS source is set to Simulated course or Simulated route. Otherwise, GPS data including speed and course come from the selected source file.

### **Set start position**

Moves your vessel to the current cursor position.

→ **Note:** This option is only available when the GPS source is set to Simulated course.

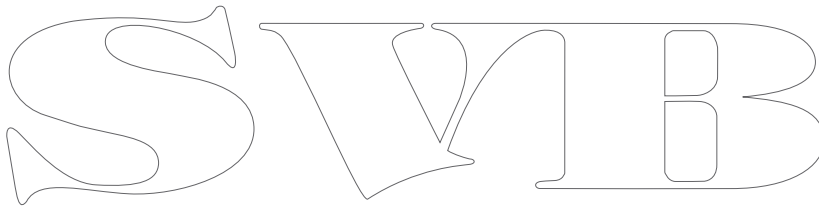



# 23

## Maintenance

### Preventive maintenance

The NSS evo2 does not contain any field serviceable components, therefore the operator is required to perform only a very limited amount of preventative maintenance.

It is recommended that you always fit the supplied protective sun cover when the unit is not in use.

### Cleaning the display unit

A proper cleaning cloth should be used to clean the screen, where possible. Use plenty of water to dissolve and take away salt remains. Crystallized salt may scratch the coating if using a damp cloth. Apply minimal pressure to the screen.

Where marks on the screen cannot be removed by the cloth alone, use a 50/50 mixture of warm water and isopropyl alcohol to clean the screen. Avoid any contact with solvents (acetone, mineral turpentine, etc.), or ammonia based cleaning products, as they may damage the anti-glare layer or plastic bezel.

To prevent UV damage to the plastic bezel, it is recommended that the sun cover be fitted when the unit is not in use for an extended period.

### Cleaning the media port door

Clean the media port door regularly to avoid salt crystallization on the surface, causing water to leak into the card slot.

### Checking the keys

Make sure that no keys are stuck in the down position. If one is stuck, wiggle the key to free it back to normal.

### Checking the connectors

The connectors should be checked by visual inspection only.

Push the connector plugs into the connector. If the connector plugs are equipped with a lock, ensure that it is in the correct position.

### NMEA Data logging

All serial output sentences sent over the NMEA TCP connection are logged to an internal file. You can export and review this file for service and fault finding purposes.

The maximum file size is predefined. If you have added several other files to the system (file recordings, music, pictures, pdf files), this may reduce the allowed file size for the log file.

The system logs as much data as possible within the file size limitation, and then it starts overwriting the oldest data.

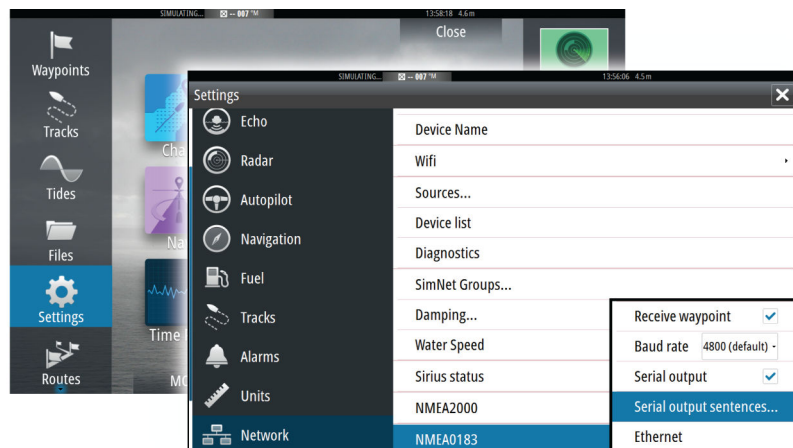

## Exporting the log file

The log file can be exported from the files browser.

When you select the Log database you are prompted to select a destination folder and filename. Once accepted, the log file is written to the chosen location.

## RSD sentence output

The output of RSD NMEA 0183 message can be enabled (default off) to provide cursor position information to an external device. The cursor position information may be used by devices such as thermal cameras with pan-tilt ability, and external radar displays.

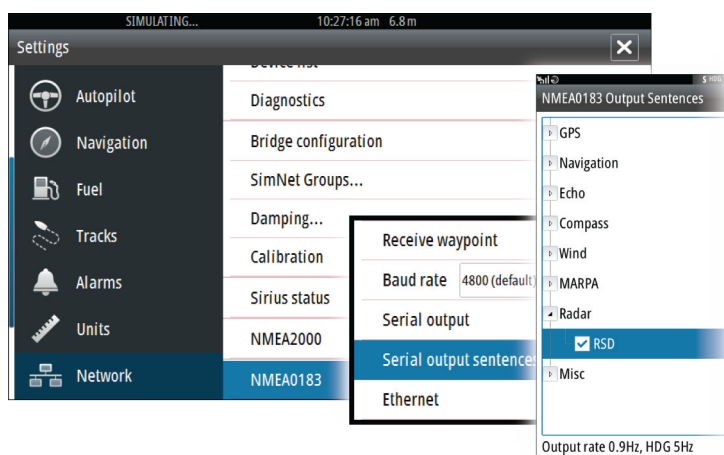

→ **Note:** The sentence format (dictated by NMEA 0183) was not written to take in to consideration dual radar systems, and therefore does not transmit identification information to distinguish between sources. When two radar PPIs are shown on the screen at the same time, only the first (left hand) radar provides RSD information. **RSD** is shown on the radar PPI to indicate this feature is enabled.

## Software upgrades

The latest software for the NSS evo2 is available for download from our website, [simrad-yachting.com](http://simrad-yachting.com).

Detailed instructions for how to install the software are included in the upgrade files.

## Backing up your system data

Waypoints, Routes, and Tracks that you create are filed in your system. It is recommended to regularly copy these files and your system settings files as part of your back-up routine. The files can be copied to a card inserted in the card reader.

There are no export file format options for the system settings file. The following output formats are available for exporting Waypoints, Routes, and Tracks files:

- **User Data File version 5**  
This is used to import and export waypoints and routes with a standardized universally unique identifier (UUID), which is very reliable and easy to use. The data includes such information as the time and date when a route was created, and so on.
- **User Data File version 4**  
This is best used when transferring data from one system to another, since it contains all the extra bits of information these systems store about items.
- **User Data file version 3 (w/depth)**  
Should be used when transferring user data from one system to a legacy product (Lowrance LMS, LCX, and so on.)
- **User data file version 2 (no depth)**  
Can be used when transferring user data from one system to a legacy product (Lowrance LMS, LCX, and so on.)
- **GPX (GPS Exchange, no depth)**

This is the format most used on the web that shares among most GPS systems in the world. Use this format if you are taking data to a competitors unit.

- **Northstar.dat (no Tracks)**  
Used to transfer data to a legacy Northstar device.

### Export all Waypoints, Routes and Tracks

Use the export option if you want to backup all Waypoints, Routes, and Tracks on your system.

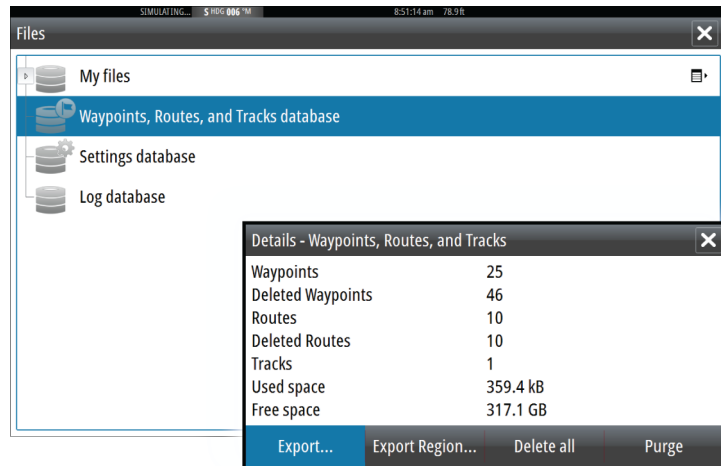
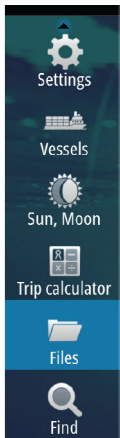

### Export region

The export region option allows you to select the area from where you want to export data.

1. Drag the boundary box to define the desired region
2. Select the export option from the menu
3. Select the appropriate file format
4. Select the serial port field to start the export



### Purging Waypoints, Routes and Tracks

Deleted Waypoints, Routes and Tracks are stored in the NSS evo2 memory until the data is purged. This is necessary to allow user data to be synchronized across multiple units on an Ethernet network. If you have numerous deleted, unpurged Waypoints, purging may improve the performance of your system.

→ **Note:** When user data is purged from the memory, it cannot be recovered.

# Index

## A

Active panel 17  
Adjusting panel size 18  
AIS 90  
  Calling a vessel 91  
  DSC 91  
  Icon filters 93  
  Icon orientation 94  
  Information on radar panels 91  
  Searching for AIS items 90  
  Target symbols 90  
  Viewing information about targets 90, 91  
AIS SART 91  
  Alarm message 92  
Alarm system 107  
Alarm  
  Critical Zone 85  
Alarms  
  Acknowledging 107  
  Alarm settings dialog 108  
  Multiple alarms 107  
  Single alarm 107  
  Type of messages 107  
Application pages 12  
Arrival alarm 44  
Arrival radius 44  
Audio 96  
  Control buttons 97  
  Detaching Sirius 98  
  Enable 96  
  Favorite channels 98  
  Master volume control 98  
  Operating 98  
  Selecting tuner region 98  
  Setting up the system 97  
  Sirius radio 98  
  Speaker zones 98  
  Speakers 98  
Audio  
  Panel 96  
Audio tools 97  
Autopilot 45  
  Activating 45  
  AP24/28 systems 53  
  AUTO mode 48  
  Autopilot panel 46  
  Autopilot pop-up 46  
  Autopilot tile in Instrument bar 46  
Chart compass 54  
Depth contour tracking 52  
Dodging 48  
EVC system 53  
Follow-up steering 47  
Gybing 50  
HI/LO parameters 55  
Indication in Status bar 45  
Indication on pages 45

Locking remote stations 53  
Mode overview 47  
Non-Follow up mode 47  
Response 55  
Sailing parameters 54  
Sea state filter 54  
Settings 54  
Standby (STBY) mode 47  
Switching to manual steering 45  
Tacking in AUTO mode 48  
Tacking in WIND mode 50  
Turn pattern steering 51  
Waypoint arrival circle 49  
WIND mode 50  
WIND Nav mode 51  
Autorouting 37  
  Entire route 37, 38  
  Example 38  
  Selection 37, 38

## B

Backing up your system data 114  
Bottom lock 74  
Bridge Control 21  
  Adding displays 21  
  Bridge presets 22  
  Configuring the preset pages 21  
  Page configurations 21

## C

Charts 23  
  3D charts 27  
  Chart compass 54  
  Chart data 23  
  Chart detail 28, 32  
  Chart panel 23  
  Chart scale 24  
  Course up 24  
  Creating routes 26  
  Dual charts 23  
  Embedded cartography 23  
  Find chart objects 26  
  Insight 27, 28  
    Chart categories 28  
    Exaggeration 28  
    Imagery style 27  
  Jeppesen  
    Tides and currents 31  
  Look ahead 24  
  Measuring distance 26  
  Navionics 28, 30  
    Annotation 30  
    Chart details 30  
    Chart shading 28  
    Colored seabed areas 30  
    Community edits 28  
    Contours depth 30  
    Depth highlight range 30

- Dynamic tides and currents 28
- Easy view 29
- Fish N' Chip 29
- Presentation type 30
- Rock filter 30
- Safety depth 30
- Shallow water highlight 30
- Orientation 24
- Overlay 27
- Panning 24
- Photo overlay, Jeppesen 32
- Photo overlay, Navionics 29
- Photo transparency, Jeppesen 32
- Photo transparency, Navionics 29
- Positioning the vessel on the chart panel 24
  - Radar overlay source 58
- Selecting chart type 24
- Settings 34
- Symbol 24
- Using the cursor 25
- Vessel symbol 24
- Zooming 24
- Chart
  - Heading up 24
  - North up 24

- Connect
  - Smartphone and tablet 87
  - Wireless hotspot 87
- Controller & Viewer
  - GoFree 87
- Converting tracks to routes 38
- Coordinate system 44
- Critical Depth 85
- Critical Forward Range 85
- Critical Zone alarm 85
- Cursor assist 25, 59, 69, 77
- Customizing your system 18
- CZone 13

## D

- Dangerous vessels 94
- Dashboards 95
- Datum 44
- DCT 52
- Demo mode 111
- Depth line 74
- Depth offset 86
- Dialog boxes 17
- Disconnect
  - Wireless hotspot 87
- Display illumination 15
- Dual Radar 57
- Dual range, Radar 58

## E

- Easy Routing 37
  - Example 38
- EBL/VRM markers 64

- Echosounder 68
  - A-Scope 74
  - Depth offset 86
  - Fish ID 74
  - Image 68
  - Network 75
  - Pausing 71
  - Ping speed 72
  - Scroll speed 72
  - Source 75
  - Split screen 73
  - Start recording echosounder data 72
  - Stop recording log data 73
  - Using the cursor 69
  - View history 70
  - View options 73
  - View recorded data 73
  - Zoom bar 69
  - Zoom bars 74
  - Zooming 69
- Echosounder
  - Split Zoom 73
- Export region 115
- Extension lines 93

## F

- Favorite pages 13
  - Adding new 19
  - Edit 19
- Files management 109
- Find items tool 110
- First time startup 15
- FLIR camera
  - Controlling 104
  - Digital zoom 105
  - Establishing connection 104
  - Home position 105
  - Integration 13
  - Optical zoom 105
  - Panning and tilting 105
  - Source options 105
  - Zooming 105
- ForwardScan 83
  - Critical Depth 85
  - Critical Forward Range 85
  - Critical Zone alarm 85
  - Heading extension 84
  - Image 83
  - Installation 75
  - Setup 85
  - Transducer angle 86
- Frequency 71
- Front panel 10
  - Keys 10
- Fuel economy gauge 20
- FUSION-Link 13, 96

## G

- Go to cursor 25, 59, 69, 77

- GoFree
  - Shop 87
  - Wireless connection 87
- GoFree
  - Controller & Viewer app 87
- Great circle 43
- GRIB weather 99
  - Animated weather forecast 100
  - Importing data 99
  - Information window 100
  - Overlay on chart panel 100

## H

- Home page 11
- Home page background 18

## I

- Illumination 15
- Improving system performance 115
- Instrument bar 19
  - Activity bar 20
  - Edit the content 20
  - Fuel economy gauge 20
  - Setting the appearance 19
  - Turning on/off 20
- Instrument panels 95
- Integration of 3rd party devices 13

## L

- Locking the touchscreen 15

## M

- Magnetic variation 44
- Man Overboard
  - Cancel navigation to MOB 17
  - Creating a MOB 17
  - Delete a MOB waypoint 17
- Manual
  - About 4
  - Version 4
- Manuals, viewing 5
- Measuring distance 26, 69, 77
- Menus 16
- MMSI number 93

## N

- Navigate 41
  - Arrival alarm 44
  - Arrival radius 44
  - Cancel navigating a route 43
  - Datum 44
  - Methods 43
    - Great circle 43
    - Rhumb lines 43
  - Nav panel 41
  - Panels 41
  - Position pane 41
  - Routes 42

- To cursor position 42
- With autopilot 43

- Navigation settings 43

- Network
  - Echosounder 75
- NMEA Data logging 113
- NMEA
  - Exporting log file 114
- Noise rejection 71

## O

- OP40 14
- Operation
  - Touch 15
- Overlay downscan 75

## P

- Pages
  - Selecting a page 17
  - Selecting active panel 17
- Palettes 74, 78
- Panels
  - Adjusting panel size 18
- Password protection 18
- PDF, viewing files 5
- Phantom Loran 44
  - Settings 44
- Pin code
  - Password protection 18
- PPI 63
- Preventive maintenance 113
- Purging 115

## R

- Radar 57
  - Alarm settings 65, 66
  - Course up 63
  - Dual 57
  - Dual range 58
  - EBL/VRM markers 64
  - EBL/VRM
    - Placing 64
  - EBL/VRM
    - Fast scan 62
    - Gain 61
    - Guard zone 64
    - Heading up 63
    - Interference 62
  - MARPA
    - Target symbols 65
    - Targets 65
    - Tracking targets 65
    - View target info 65
  - North up 63
  - Offset 64
  - Operational modes 58
  - Orientation 63
  - Overlay 58
  - Palette 63

- Position radar center 63
  - PPI 63
  - Radar overlay source 58
  - Radar panel 57
  - Rain clutter 62
  - Range 58
  - Recording data 66
  - Sea clutter 61
  - Sea State 62
  - Sensitivity 65
  - Settings 66
  - Source 58
  - Target boost 62
  - Target expansion 62
  - Target trails 63
  - Threshold 62
  - True motion 64
  - Range 70
  - Record echosounder data 79
  - Recording
    - Start recording echosounder data 72
    - Start recording log data 72
  - Rhumb lines 43
  - Routes 37
    - Autorouting 37
    - Converting tracks to routes 38
    - Creating a new route on the chart panel 37
    - Creating a route from existing waypoints 38
    - Edit in chart panel 37
    - Edit-Route dialog 39
    - Navigate 42
  - Routes
    - Dialog 40
- S**
- Saving waypoints 25, 36, 59, 70, 77
  - Screen capture 17
  - Sea State 62
  - Search depth 75
  - Settings
    - Autopilot 54
    - Tools 109
  - Simulator 111
    - Demo mode 111
    - Source files 111
  - Sirius radio 98
    - Channels list 98
    - Favorite list 98
    - Locking channels 98
  - Sirius weather
    - Animated weather graphics 103
    - Color codes 103
    - Marine zones 102
    - Overlay on chart panel 101
    - Precipitation 102
    - Sea Surface Temperature (SST) 102
    - Status panel 101
    - Tropical statements 103
    - Wave indication 102
    - Weather icons 102
  - SiriusXM weather 101
  - SL2 format 72
  - SL3 format 72
  - SLG format 72
  - SmartCraft VesselView 13
  - Software upgrade 114
  - Software version 5
  - SonicHub 96
  - Speaker zones 98
  - Speakers 98
  - Speed and course indication 94
  - Split pages 12
    - Pre-configured 13
  - Split screen
    - Echosounder 73
  - Split zoom
    - Echosounder 73
  - StructureMap 73, 80
    - Activate 80
    - Image 80
    - Live source 80
    - Mapping cards 81
    - Options 81
    - Saved files 81
    - Sources 80
    - Tips 81
  - StructureScan 76
    - Advanced settings 79
    - Auto range 78
    - Contrast 78
    - Convert data to StructureMap format 81
    - Custom range 78
    - Flipping the image 79
    - Frequencies 78
    - Image 76
    - Noise rejection 82
    - Pausing the image 78
    - Preset range levels 78
    - Range 78
    - Range lines 79
    - Recording data 81
    - Using the cursor 76
    - View history 78
    - View options 76
    - Zooming 76
  - System Settings
    - Coordinate system 44
    - Datum 44
    - Magnetic variation 44
- T**
- Temperature graph 74
  - Time plot panel 106
    - Missing data 106
  - Time plots 106
    - Selecting data 106
  - Tools 109

- Tools
  - Files 109
  - Find items 110
  - Settings 109
- Touch
  - Operation 15
- Touchscreen
  - Locking 15
- Tracks
  - Dialog 40
- Tracks
  - Creating new 39
  - Settings 39
- Transducer angle, ForwardScan 86
- Turn pattern steering
  - Autopilot 51
- Turning the unit on and off 15
- TVG 71, 79

## V

- Vessel alarms 92
- Vessel settings 93
- Video 104
  - Adjusting the image 104
  - Setting up the panel 104
  - Source 104
    - Standard 104
  - Video panel 104
  - View Echosounder log 75

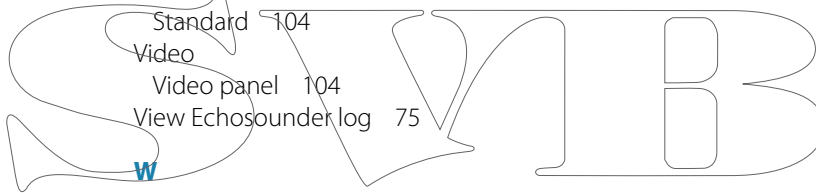

## W

- Wallpaper, customizing 18
- Warranty 4
- Waypoints, routes and tracks
  - Export 115
  - Purging 115
- Waypoints 36
  - Alarm settings 36
  - Dialog 40
  - Edit 36
  - Moving 36
  - Saving 25, 36, 59, 70, 77
- Weather 99
  - Alarms 103
  - Showing weather details 99
- Wind barbs 99
- Wireless hotspot
  - Connect and disconnect 87

## X

- XTE limit 44
- xtf format 72



SWIB



**SIMRAD**