

Font panel

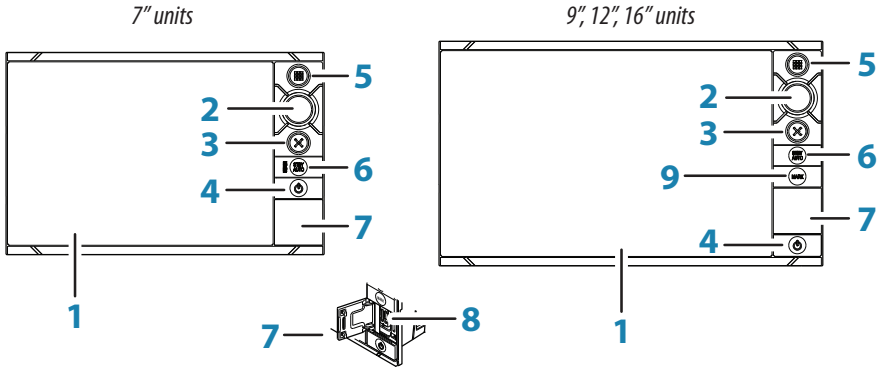

| No. | Description |
|-----|---|
| 1 | Touch screen |
| 2 | Rotary knob. Rotate to scroll through menu items, then press to confirm a selection. Rotate to adjust a value and to zoom a zoomable panel. |
| 3 | X key. Press once to exit a dialog, to return to previous menu level and to remove the cursor from the panel. |
| 4 | Power key. Press once to display the System control dialog. Repeat short presses to cycle the backlight brightness. Press and hold to turn the unit ON/OFF. |
| 5 | Home key. Press once to display the Home page. Repeat short presses to cycle the favorite buttons. Press and hold to display all favorite buttons as an overlay on active page. Repeat short presses to cycle the favorite buttons. |
| 6 | STBY / AUTO key. With the autopilot in any automatic mode: Press to set the autopilot to Standby mode. With the autopilot in Standby mode: Press to display the autopilot mode selection pop-up. |
| 7 | Card reader door |
| 8 | Micro-SD Card readers |
| 9 | MARK key. Press to instantly save a waypoint at the vessel's position. Press and hold to display the Plot menu used for saving new waypoints, routes and tracks. |

→ **Note:** The **MARK** key is not available on 7" units.

The System Control dialog

Used for quick access to system settings.

Activate the dialog by:

- pressing the **Power** key, or by
- swiping from the top of the screen

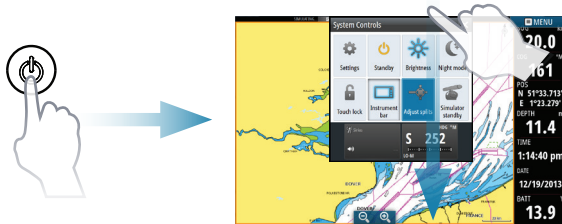

→ **Note:** The content of the System Control dialog depends on connected equipment and active panel.

The Home page

Activate the Home page by pressing the **Home** key.

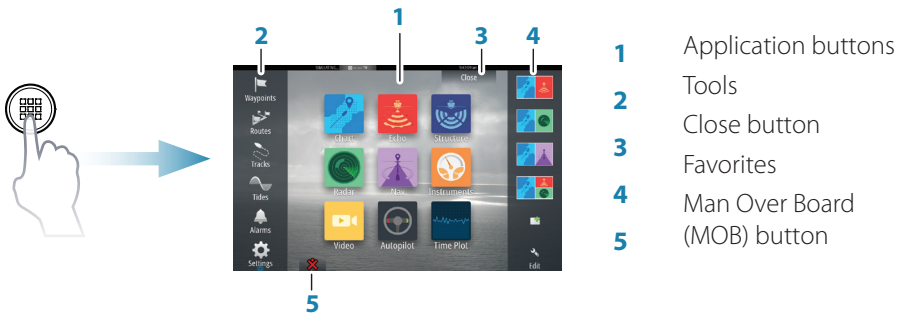

- 1 Application buttons
- 2 Tools
- 3 Close button
- 4 Favorites
- 5 Man Over Board (MOB) button

You can customize the Home page background by adding your own .png or .jpg file.

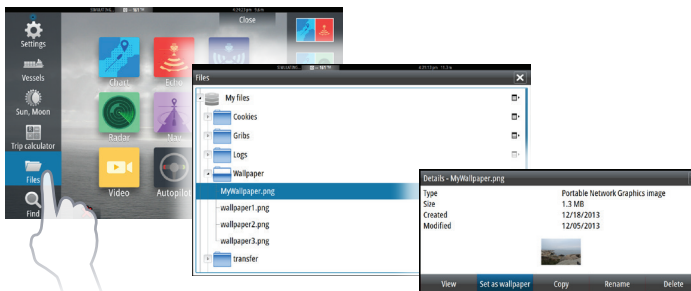

Application pages

Activate an application page by:

- tapping the application button (full page panel), by
- tapping a favorites button, or by
- pressing and holding an application button to select a predefined split page.

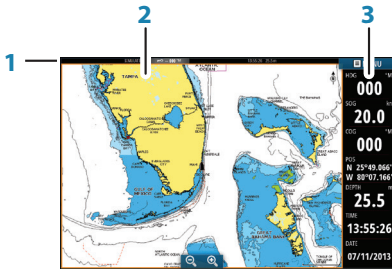

- 1 Status panel
- 2 Application panel
- 3 Instrument bar

Adjust panel size

You can adjust the panel sizes in a split page.

1. Tap the adjust split button in the System Control dialog to show the resize icon
2. Drag the resize icon to set preferred panel size
3. Save the changes by tapping the screen.

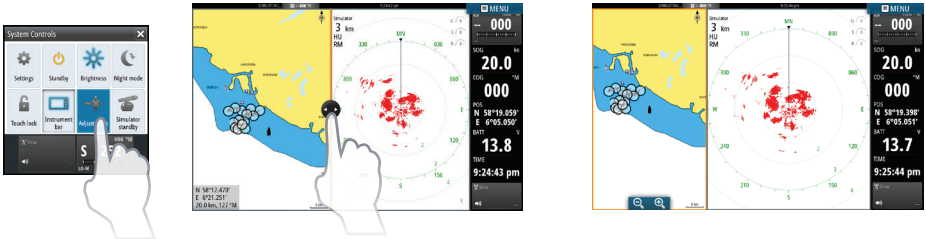

Favorite page overlay

Display the favorite buttons as a pop-up on any page by pressing and holding the Home key.

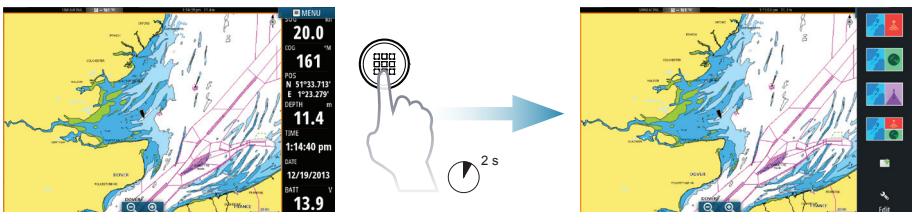



Edit a favorite page

Enter the Favorites edit mode by:

- tapping the Edit icon, or by
- pressing and holding a favorite button



-  Edit favorite page
-  Delete favorite page
-  Add new favorite page

Edit an existing favorite page or configure a new page by dragging panel icons into or out from the preview area.

Save the changes by tapping the **Save** button.

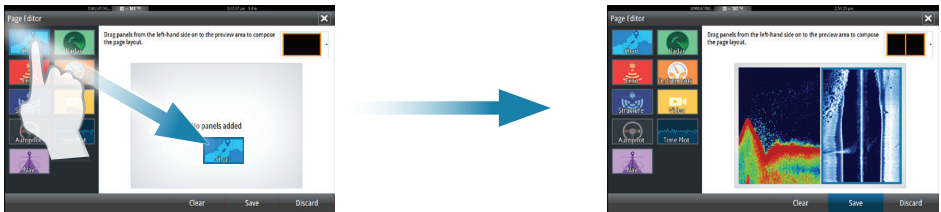

The Instruments bar

Tap the Instrument bar button in the System Control dialog to turn the bar on/off.

To edit the content of the Instrument bar:

1. Tap the Instrument bar to make it active
2. Select the edit option from the menu
3. Tap the item you want to change
4. Select the information you want to display in the Instrument bar
5. Save the changes by selecting the save option in the menu.

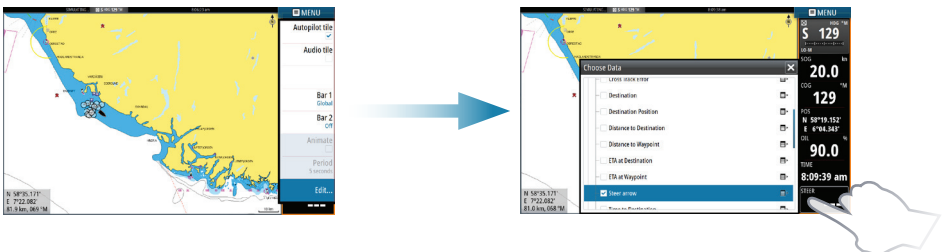

Charts

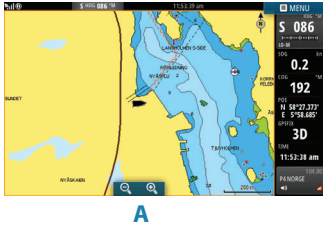

- Zoom the chart by using spread or pinch gestures, by using the zoom buttons (**A**), or by turning the **Rotary** knob.
- Move the view in any direction by panning the chart.
- Display information about a chart item by tapping the item.

Waypoints

Save a waypoint at the vessel's position by:

- using the new waypoint option in the menu, or by
- pressing the **MARK** key.



To save a waypoint at selected position:

1. Tap the screen at selected position
2. Select the new waypoint option in the menu, or press the **MARK** key.

→ **Note:** The **MARK** key is not available on 7" units

Routes

To create a route:

1. Tap the screen
2. Select the new route option in the menu
3. Tap the chart to position the first routepoint
4. Continue tapping the screen to position additional waypoints
5. Save the route by selecting the save option from the menu.



Navigating

To navigate to cursor position:

1. Tap the screen to positioning the cursor
2. Select the goto cursor option in the menu.

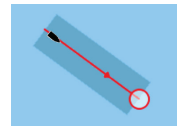

Navigate a predefined route by:

- tapping the route to make it active, then selecting the goto route option in the menu, or by
- selecting the route from the Routes dialog, then selecting the goto option in the dialog

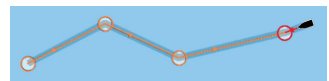

Overlay

Add a radar, weather or StructureScan overlay on the chart by selecting the option in the menu.

Echosounder

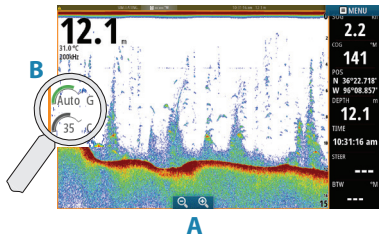

- Zoom the image by tapping the zoom buttons (A) or by turning the **Rotary** knob.
- View echosounder history by panning the image.
- Adjust gain and color from the slide bar, displayed by tapping the gain or color icon (B), or by pressing the **Rotary** knob.
- Toggle auto gain on/off from the menu, or by pressing and holding the **Rotary** knob.

Toggle available echosounder frequencies from the menu. Available options depend on type of transducers connected to the system.

| | | |
|------------------------------|--------------|--|
| Single frequency transducers | 50 kHz | Lower resolution images. Best performance in deep water |
| | 83 kHz | Greater water coverage |
| | 200 kHz | High resolution images and better target separation in shallow water |
| Chirp transducers | Low CHIRP | Lower resolution images. Best performance in deep water |
| | Medium CHIRP | Better depth penetration than High CHIRP, but with minimal loss of target definition |
| | High CHIRP | High resolution images and better target separation in shallow water |

StructureScan



- Select Downscan or Sidescan view from the menu
- Zoom the image by tapping the screen to position the cursor, then tap the zoom buttons (A) or turn the **Rotary** knob
- Adjust contrast manually from the slide bar, displayed by tapping the Contrast icon (B), or by pressing the **Rotary** knob

Toggle between available StructureScan frequencies from the menu.

| | |
|---------|---|
| 455 kHz | Excellent resolution and greater range than 800 kHz |
| 800 kHz | Better definition than 455 kHz at shallower depths |

Autopilot

You can activate the autopilot from any panel.

1. Press the **STBY/AUTO** key or the Autopilot tile in the Instrument bar
2. Select the autopilot mode in the Autopilot pop-up

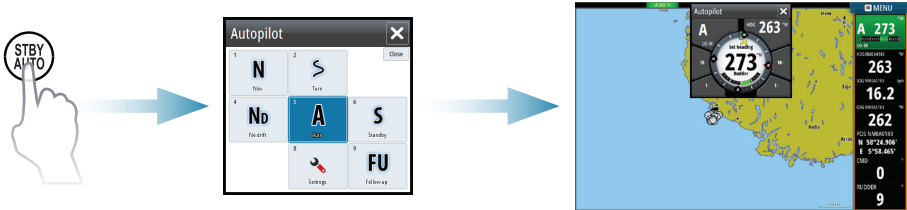

| | | |
|----------------------|-------------------|--|
| S | Standby | Autopilot is passive. Used when manually steering at the helm |
| FU | Follow-up | Manual steering. The rudder angle is set by the Rotary knob or by another FU unit |
| NFU | Non-Follow-up | Manual steering. The rudder movement is controlled by the Port and Starboard buttons in the Pilot pop-up, or by another NFU unit |
| A | Auto | Automatic steering, maintaining the set heading |
| Nd | NoDrift | Automatic steering, keeping the vessel on a straight bearing line by compensating for drift |
| N | Navigation | Automatic steering, navigating the vessel to a specific waypoint or through a route using GPS data |
| W | Wind * | Automatic steering, maintaining the set wind angle |
| W_N | Wind navigation * | Automatic steering, navigating the vessel to a specific waypoint or through a route using both wind and GPS data |

* Only available if the boat type is set to Sailboat.

→ **Note:** You switch the autopilot to Standby mode from any automatic mode by a short press on the **STBY/AUTO** key.

Adjust set heading / course / wind angle



Adjust set heading (Auto mode), set wind angle (Wind mode) and set course (NoDrift mode) by:

- tapping the **Port** or **Starboard** buttons in the autopilot pop-up, or by
- turning the **Rotary** knob.

Radar

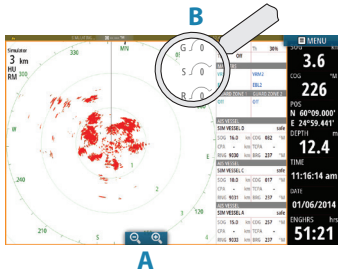

- Turn the radar transmitting on/off from the menu.
- Set the range by using the zoom icons (A) or by turning the **Rotary** knob.
- Adjust gain, sea clutter and rain clutter settings from the slide bar, displayed by tapping the settings icons (B), or by pressing the **Rotary** knob.

Audio

Activate the Audio overlay by tapping the **Audio** tile in the Instrument bar.



Positioning a MOB mark

Save a Man Over Board (MOB) mark at vessel position by tapping the **MOB** button on the Home page.

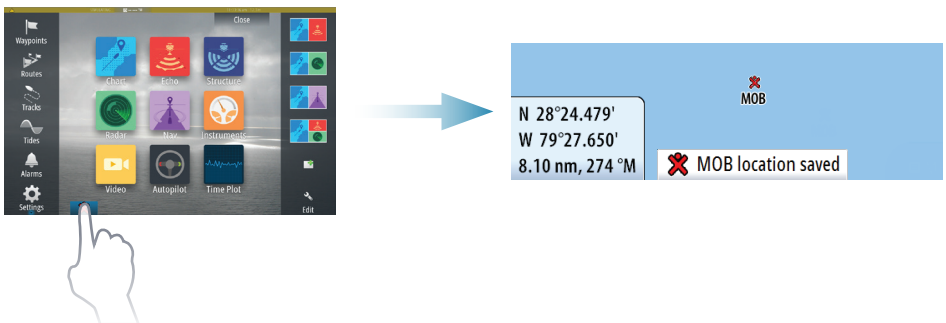

For more details, see the NSS evo2 Operator manual.

