

LED Batten Light Manual

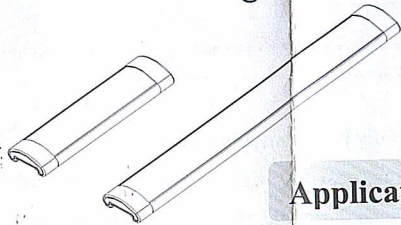

Application

Hotels, meeting rooms, offices, shopping malls, supermarkets, hospitals, monkey, warehouse, passages, indoor parking lot and other need to be energy saving and high color rendering place.

Product main feature

It is made up of high brightness led chip, constant current driver, excellent housing and high light transmittance PC cover. Batten light is long life span, very stable and reliable. Excellent housing is anodic oxidation after pure aluminum profiles processed. It will never change colour and good heat dissipation. PC cover is optical high pervious, which is high light transmittance and luminous uniform soft. No Flicker, no noise, no glare, lead-free, no mercury and other harmful substances. It is easy installation and many installation way, such as ceiling or hanging. Batten light is widely used in meeting rooms, high-grade offices, underground parking, household, aisle, shopping malls, supermarkets and other places.

Item No.	1ft/0.3M	2ft/0.6M	3ft/0.9M	4ft/1.2M	5ft/1.5M	6ft/1.8M
Input Voltage (V)	180-265 <i>DL10-30</i>					
Rated Current (mA)	50	100	150	200	300	400
Frequency (Hz)	50/60					
Power (W)	10	20	30	40	60	72
Color Temperature(K)	3000-6500K					
Luminous Flux (Lm)	>900	>1800	>2000	>3600	>5400	>6500
IP Rating	IP44					
Dimension(mm)	L580*80*36	L580*80*36	L880*80*36	L1190*80*36	L1480*80*36	L1780*80*36

IP44

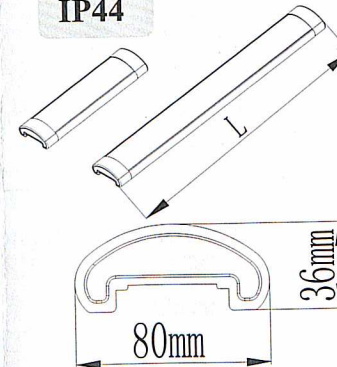

Installation Instructions

A. Make a right position for screw hole

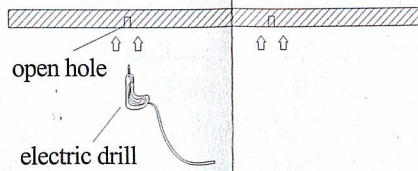

B. Screw the clip on the ceiling tightly

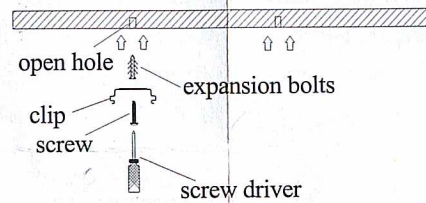

C. electric wire connect to the lamp

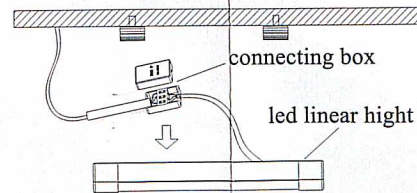

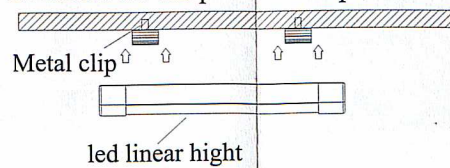

D. Install the lamp into the clips

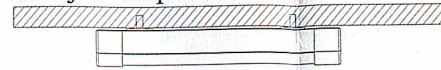

E. Adjust the position of the fixture



Note

- Please read product manual carefully before installing and using;
- Please confirm the packing label is consistent with the product, make sure the products have been not damaged during the transit, or cannot be used to installation;
- Please confirm whether the switch before installation wiring and electric processing closed state;
- Do not touch the product case and avoid eyes look shiny surface for a long time;
- The light source of this luminaire is not replaceable; when the light source reaches its end of life the whole luminaire shall be replaced. Please inspection, maintenance or scrap processing after product service life.
- Type Y: If the external flexible cable or cord of this luminaire is damaged, it shall be exclusively replaced by the manufacturer or his service agent or a similar qualified person in order to avoid a hazard.
- IP44 suitable for indoor and outdoor use.
- Caution, risk of electric shock 
-  Forbidden non-professional worker dismantle and maintain products, must be installed by a licensed electrician.

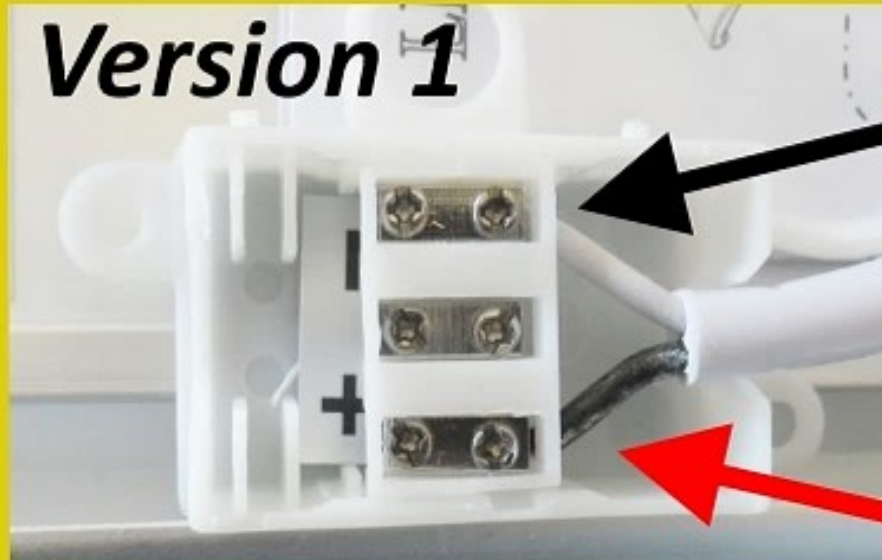

Version 1

MINUS

PLUS

10-30 V DC

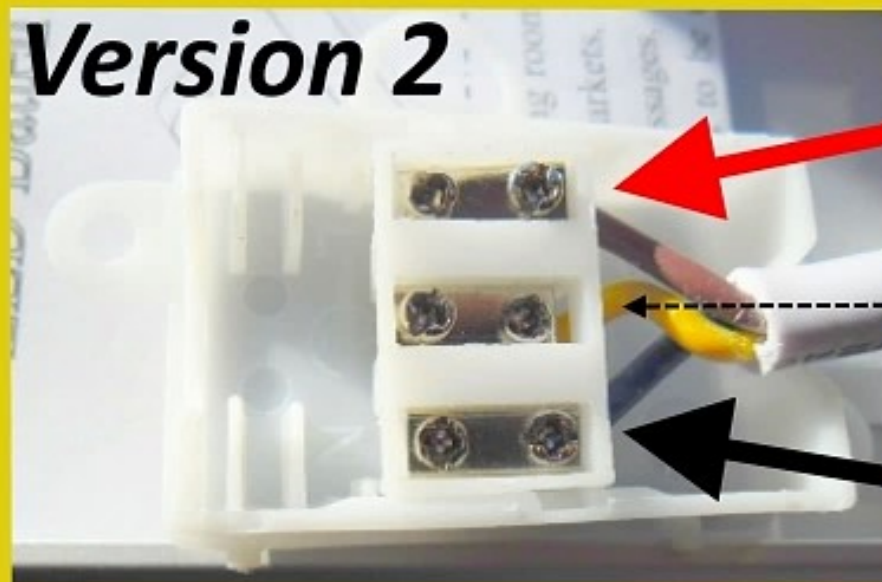

Version 2



*Gehäuse/housing/
alloggiamento/boîtier*

MINUS

SVB-# 25455