

GARMIN[®]

REACTOR™ 40 HYDRAULIC

Installation Instructions

Important Safety Information

WARNING

See the *Important Safety and Product Information* guide in the product box for product warnings and other important information.

You are responsible for the safe and prudent operation of your vessel. The autopilot is a tool that enhances your capability to operate your boat. It does not relieve you of the responsibility of safely operating your boat. Avoid navigational hazards and never leave the helm unattended.

Always be prepared to promptly regain manual control of your boat.

Learn to operate the autopilot on calm and hazard-free open water.

Use caution when operating the autopilot near hazards in the water, such as docks, pilings, and other boats.

CAUTION

When in use, beware of hot motor and solenoid components and the risk of entrapment from moving parts.

Failure to install and maintain this equipment in accordance with these instructions could result in damage or injury.

NOTICE

To avoid damage to your boat, the autopilot system should be installed by a qualified marine installer. Specific knowledge of hydraulic steering componentry and marine electrical systems is required for proper installation.

Registering Your Device

Help us better support you by completing our online registration today. Keep the original sales receipt, or a photocopy, in a safe place.

- 1 Go to my.garmin.com/registration.
- 2 Sign in to your Garmin[®] account.

Installation Preparation

The autopilot system consists of multiple components. You should familiarize yourself with all of the component mounting and connection considerations before beginning installation. You must know how the components operate together in order to correctly plan the installation on your boat.

You can consult the layout diagrams (*Power and Data Layout, page 2*) to help understand the mounting and connection considerations.

You should lay out all of the components on the boat as you plan the installation to make sure your cables will reach each component. If needed, extension cables (sold separately) for various components are available from your Garmin dealer or from www.garmin.com.

You should record the serial number of each component for registration and warranty purposes.

Tools Needed

- Safety glasses
- Drill and drill bits
- 90 mm (3.5 in.) hole saw or a rotary cutting tool (for installing an optional helm control)
- Wire cutters/strippers
- Phillips and flat screwdrivers

- Cable ties
- Waterproof wire connectors (wire nuts) or heat-shrink tubing and a heat gun
- Marine sealant
- Portable or handheld compass (to test for magnetic interference)

NOTE: Mounting screws are provided for the main components of the autopilot system. If the provided screws are not appropriate for the mounting surface, you must provide the correct types of screws.

Mounting and Connection Considerations

The autopilot components connect to each other and to power using the included cables. Ensure that the correct cables reach each component and that each component is in an acceptable location before mounting or wiring any components.

CCU Mounting and Connection Considerations

- The CCU is the primary sensor of the Reactor 40 Hydraulic autopilot system. For best performance, observe these considerations when selecting a mounting location.
 - A handheld compass should be used to test for magnetic interference in the area where the CCU is to be mounted (*Testing a Location for Magnetic Interference, page 1*).
 - The CCU should be mounted on a rigid surface for best performance.
- Mounting screws are provided with the CCU. If you use mounting hardware other than the provided screws, the hardware must be quality stainless or brass material to avoid magnetic interference with the CCU.

Test any mounting hardware with a handheld compass to make sure no magnetic fields are present in the hardware.
- The CCU cable connects the CCU to the ECU and is 5 m (16 ft.) long.
 - If the CCU cannot be mounted within 5 m (16 ft.) of the ECU, extension cables are available from your local Garmin dealer or at www.garmin.com.
 - This cable must not be cut.

Finding the Best Mounting Location

- 1 Create a list of all suitable mounting locations for the CCU. Suitable mounting locations should not be within 60 cm (2 ft.) of the following:
 - Iron
 - Magnets
 - High-current wires
 - Intermittently-running pumps, such as head pumps and live well pumps

A large magnet, such as a subwoofer-speaker magnet, should be no closer than 1.5 m (5 ft.) to any of the mounting locations.
- 2 Locate the center of rotation of the boat, and measure the distance between the center of rotation and each of the suitable mounting locations you listed in step 1.
- 3 Select the location closest to the center of rotation.

If more than one location is approximately the same distance from the center of rotation, you should select the location that best meets these considerations.

 - The best location is closest to the centerline of the boat.
 - The best location is lower in the boat.
 - The best location is slightly forward in the boat.

Testing a Location for Magnetic Interference

You can use a handheld compass to test a mounting location for magnetic interference.

- 1 Hold a handheld compass in the CCU mounting location.

- 2 Move the compass six inches to the left of the location, then six inches to the right, observe the needle, and select an action:
 - If the compass needle moves more than three degrees during this step, magnetic interference is present. Select a new mounting location and repeat the test.
 - If the compass needle does not move, or moves less than three degrees, proceed to the next step.
- 3 Repeat this process while moving the compass above and below the mounting location.
- 4 Repeat this process while moving the compass in front of and behind the mounting location.

ECU Mounting and Connection Considerations

- The ECU can be mounted on a flat surface, facing any direction.
- Mounting screws are included with the ECU, but you may need to provide different screws if the supplied screws are not suitable for the mounting surface.
- The ECU must be mounted within 0.5 m (19 in.) of the pump.
 - The cables connecting the ECU to the pump cannot be extended.
- The ECU must be mounted in a location where it will not be submerged or exposed to wash down.
- The ECU power cable connects to the boat battery, and it can be extended if needed ([Power Cable Extensions](#), page 4).

Shadow Drive™ Mounting Considerations

NOTE: The Shadow Drive is a sensor you install in the hydraulic steering lines of your boat. It detects when you manually take control of the helm and suspends autopilot control of the boat.

- The Shadow Drive must be mounted horizontally and as level as possible, with cable ties firmly securing it in place.
- The Shadow Drive must be mounted at least 305 mm (12 in.) away from magnetic materials or devices, such as speakers or electric motors.
- The Shadow Drive should be mounted closer to the helm than to the pump.
- The Shadow Drive should be mounted lower than the lowest helm, but higher than the pump.
- The Shadow Drive must not be connected directly to the fitting at the back of the helm. There must be a length of hose between the fitting at the helm and the Shadow Drive.
- The Shadow Drive must not be connected directly to a hydraulic T-connector in the hydraulic line. There must be a length of hose between a T-connector and the Shadow Drive.
- In a single-helm installation, there must not be a T-connector between the helm and the Shadow Drive.
- In a dual-helm installation, the Shadow Drive should be installed between the pump and the hydraulic T-connector that leads to the upper and lower helm, closer to the T-connector than to the pump.
- The Shadow Drive must be installed in either the starboard steering line or the port steering line.
The Shadow Drive must not be installed in either the return line or the high-pressure line, if applicable.

Alarm Mounting and Connection Considerations

- The alarm should be mounted near the primary helm station.
- The alarm can be mounted under the dashboard.
- If needed, the alarm wires can be extended with 28 AWG (0.08 mm²) wire.

NMEA 2000® Connection Considerations

- The CCU and the helm control must connect to a NMEA 2000 network.

- If your boat does not already have a NMEA 2000 network, one can be built using the included NMEA 2000 cables and connectors ([Building a Basic NMEA 2000 Network for the Autopilot System](#), page 5).
- To use the advanced features of the autopilot, optional NMEA 2000 devices, such as a wind sensor, a water-speed sensor, or a GPS device, can be connected to the NMEA 2000 network.

Power and Data Layout

⚠ WARNING

When connecting the power cable, do not remove the in-line fuse holder. To prevent the possibility of injury or product damage caused by fire or overheating, the appropriate fuse must be in place as indicated in the product specifications. In addition, connecting the power cable without the appropriate fuse in place voids the product warranty.

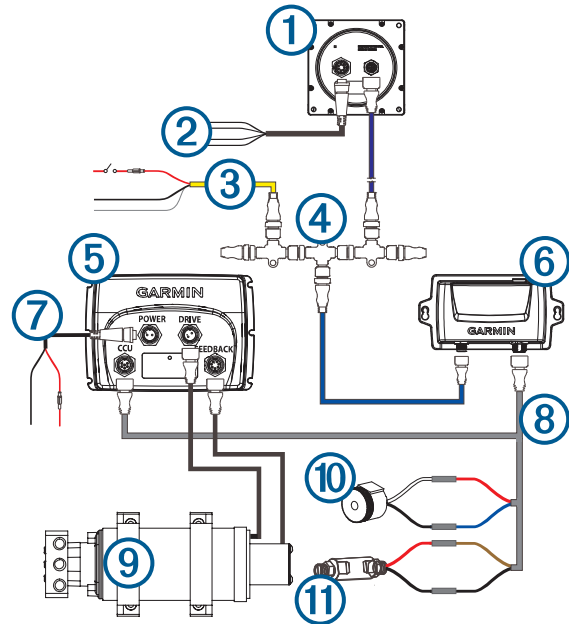

Item	Description	Important Considerations
①	Helm control	A dedicated helm control is not included in all autopilot packages. If you install the autopilot without a dedicated helm control, the autopilot CCU must be connected to the same NMEA 2000 network as a compatible Garmin chartplotter to configure and control the autopilot system.
②	Helm control data cable	You should install this cable only if you are connecting the autopilot to optional NMEA® 0183 devices, such as a wind sensor, a water-speed sensor, or a GPS device (NMEA 0183 Connection Considerations , page 7).
③	NMEA 2000 power cable	You should install this cable only if you are building a NMEA 2000 network. Do not install this cable if there is an existing NMEA 2000 network on your boat. You must connect the NMEA 2000 power cable to a 9 to 16 Vdc power source.
④	NMEA 2000 network	You must connect the helm control or compatible Garmin chartplotter and the CCU to a NMEA 2000 network using the included T-connectors (NMEA 2000® Connection Considerations , page 2). If there is not an existing NMEA 2000 network on your boat, you can build one using the supplied cables and connectors (Building a Basic NMEA 2000 Network for the Autopilot System , page 5).
⑤	ECU	

Item	Description	Important Considerations
⑥	CCU	You can mount the CCU in a non-submerged location near the center of the boat, in any orientation (<i>CCU Mounting and Connection Considerations, page 1</i>). Mount the CCU away from sources of magnetic interference.
⑦	ECU power cable	You must connect the ECU to a 12 to 24 Vdc power source. To extend this cable, use the correct wire gauge (<i>Power Cable Extensions, page 4</i>).
⑧	CCU cable	To extend this cable to reach the ECU, you may need to use cable extensions (sold separately) (<i>CCU Mounting and Connection Considerations, page 1</i>). You must connect this cable to the alarm and the Shadow Drive valve.
⑨	Pump	This diagram shows only the electrical connections for the pump (sold separately). Detailed installation instructions are included with the pump.
⑩	Alarm	The alarm provides audible alerts from the autopilot system, and you should install it near the primary helm station (<i>Installing the Alarm, page 5</i>).
⑪	Shadow Drive valve	You must install the Shadow Drive valve properly in the hydraulic steering line, and connect it to the CCU cable (<i>Installing the Shadow Drive Valve, page 5</i>).

Component Layout

Single-Helm Layout

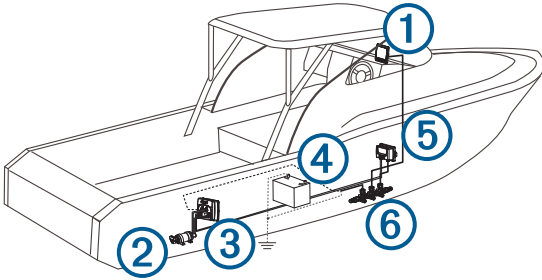

NOTE: This diagram is for planning purposes only. If needed, specific connection diagrams are included in the detailed installation instructions for each component.

Hydraulic connections are not shown in this diagram.

Item	Description	Important Considerations
①	Helm control	A dedicated helm control is not included in all autopilot packages. If you install the autopilot without a dedicated helm control, the autopilot CCU must be connected to the same NMEA 2000 network as a compatible Garmin chartplotter to configure and control the autopilot system.
②	Pump	
③	ECU	
④	12 to 24 Vdc battery	You must connect the ECU to a 12 to 24 Vdc power source. To extend this cable, use the correct wire gauge (<i>Power Cable Extensions, page 4</i>). You must connect the NMEA 2000 power cable to a 9 to 16 Vdc power source.

Item	Description	Important Considerations
⑤	CCU	You can mount the CCU in a non-submerged location near the center of the boat, in any orientation (<i>CCU Mounting and Connection Considerations, page 1</i>). Mount the CCU away from sources of magnetic interference.
⑥	NMEA 2000 network	You must connect the helm control or compatible Garmin chartplotter and the CCU to a NMEA 2000 network using the included T-connectors (<i>NMEA 2000® Connection Considerations, page 2</i>). If there is not an existing NMEA 2000 network on your boat, you can build one using the supplied cables and connectors (<i>Building a Basic NMEA 2000 Network for the Autopilot System, page 5</i>).

Dual-Helm Layout Guidelines

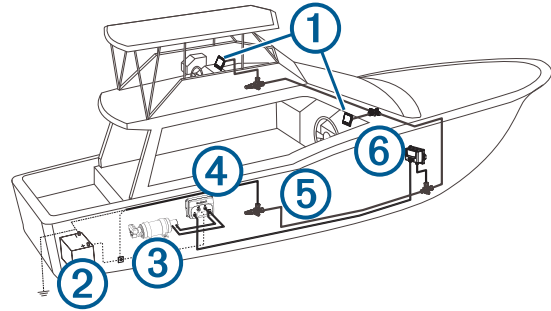

NOTE: This diagram is for planning purposes only. If needed, specific connection diagrams are included in the detailed installation instructions for each component.

Hydraulic connections are not shown in this diagram.

Item	Description	Important Considerations
①	Helm control	A dedicated helm control is not included in all autopilot packages. If you install the autopilot without a dedicated helm control, the autopilot CCU must be connected to the same NMEA 2000 network as a compatible Garmin chartplotter to configure and control the autopilot system.
②	12 to 24 Vdc battery	You must connect the ECU to a 12 to 24 Vdc power source. To extend this cable, use the correct wire gauge (<i>Power Cable Extensions, page 4</i>). You must connect the NMEA 2000 power cable to a 9 to 16 Vdc power source.
③	Pump	
④	ECU	
⑤	NMEA 2000 network	You must connect the helm control or compatible Garmin chartplotter and the CCU to a NMEA 2000 network using the included T-connectors (<i>NMEA 2000® Connection Considerations, page 2</i>). If there is not an existing NMEA 2000 network on your boat, you can build one using the supplied cables and connectors (<i>Building a Basic NMEA 2000 Network for the Autopilot System, page 5</i>).
⑥	CCU	You can mount the CCU in a non-submerged location near the center of the boat, in any orientation (<i>CCU Mounting and Connection Considerations, page 1</i>). Mount the CCU away from sources of magnetic interference.

Installation Procedures

⚠ CAUTION

Always wear safety goggles, ear protection, and a dust mask when drilling, cutting, or sanding.

NOTICE

When drilling or cutting, always check what is on the opposite side of the surface.

After you have planned the autopilot installation on your boat and satisfied all of the mounting and wiring considerations for your particular installation, you can begin mounting and connecting the components.

Helm Control Installation

A dedicated helm control is not included in all autopilot packages. If you install the autopilot without a dedicated helm control, the autopilot CCU must be connected to the same NMEA 2000 network as a compatible Garmin chartplotter to configure and control the autopilot system.

Detailed mounting instructions are included in the helm control box.

Mounting the CCU

- 1 Determine the mounting location.
- 2 Using the CCU as a template, mark the two pilot hole locations on the mounting surface.
- 3 Using a 3 mm ($1/8$ in.) bit, drill the pilot holes.
- 4 Use the included screws to attach the CCU to the mounting surface.

NOTE: If you use mounting hardware other than the provided screws, the hardware must be quality stainless or brass material to avoid magnetic interference with the CCU.

Test any mounting hardware with a handheld compass to make sure no magnetic fields are present in the hardware.

ECU Installation

Mounting the ECU

Before you can mount the ECU, you must select a location and determine the correct mounting hardware ([ECU Mounting and Connection Considerations](#), page 2).

- 1 Hold the ECU in the intended mounting location and mark the locations of the mounting holes on the mounting surface, using the ECU as a template.
- 2 Using a drill bit appropriate for the mounting surface and selected mounting hardware, drill the four holes through the mounting surface.
- 3 Secure the ECU to the mounting surface using the selected mounting hardware.

Connecting the ECU to Power

⚠ WARNING

When connecting the power cable, do not remove the in-line fuse holder. To prevent the possibility of injury or product damage caused by fire or overheating, the appropriate fuse must be in place as indicated in the product specifications. In addition, connecting the power cable without the appropriate fuse in place voids the product warranty.

You should connect the ECU power cable directly to the boat battery, if possible. Although it is not recommended, if you connect the power cable to a terminal block or other source, you must connect it through a 40 A fuse.

If you plan to route the ECU power through a breaker or a switch near the helm, you should consider using an appropriately sized relay and control wire instead of extending the ECU power cable.

- 1 Route the connector-terminated end of the ECU power cable to the boat battery, but do not connect it to the ECU.

- 2 Route the bare-wire end of the ECU power cable to the boat battery.
If the wire is not long enough, it can be extended ([Power Cable Extensions](#), page 4).
- 3 Connect the black wire (-) to the negative (-) terminal of the battery, and connect the red wire (+) to the positive (+) terminal of the battery.
- 4 After you install all of the other autopilot components, connect the power cable to the ECU.

Power Cable Extensions

If necessary, you can extend the power cable using the appropriate wire gauge for the length of the extension.

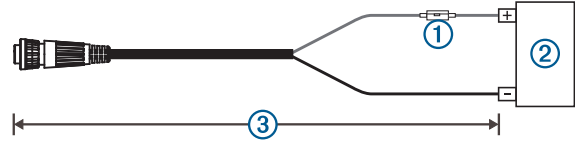

Item	Description
①	Fuse
②	Battery
③	9 ft. (2.7 m) no extension

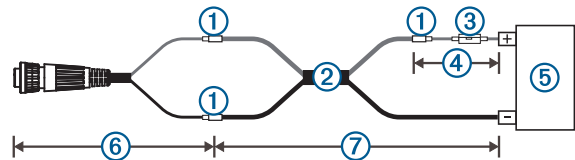

Item	Description
①	Splice
②	10 AWG (5.26 mm ²) extension wire
③	Fuse
④	8 in. (20.3 cm)
⑤	Battery
⑥	8 in. (20.3 cm)
⑦	Up to 15 ft. (4.6 m)

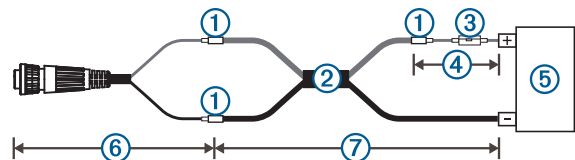

Item	Description
①	Splice
②	8 AWG (8.36 mm ²) extension wire
③	Fuse
④	8 in. (20.3 cm)
⑤	Battery
⑥	8 in. (20.3 cm)
⑦	Up to 23 ft. (7 m)

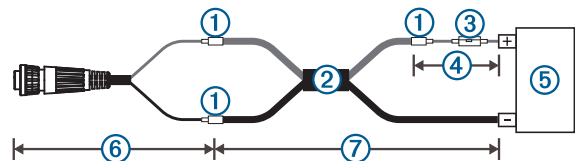

Item	Description
①	Splice
②	6 AWG (13.29 mm ²) extension wire
③	Fuse

Item	Description
④	8 in. (20.3 cm)
⑤	Battery
⑥	8 in. (20.3 cm)
⑦	Up to 36 ft. (11 m)

Installing the Pump

The pump (sold separately) must be installed in your hydraulic steering lines so the Reactor 40 Hydraulic autopilot can steer your boat. When you purchase a pump sold by Garmin, it will have the correct cables, connectors, and instructions.

Follow the installation instructions provided with your pump to mount it and connect it to your hydraulic steering system correctly.

Connecting the CCU

- 1 Route the connector end of the CCU cable to the ECU and make the connection.
- 2 Route the orange and blue wires from the bare-wire portion of the CCU cable to the location where you plan to install the alarm (*Installing the Alarm, page 5*).
If the cable is not long enough, extend the appropriate wires with 0.08 mm² (28 AWG) wire.
- 3 Route the brown and black wires from the bare-wire portion of the CCU cable to the location where you plan to install the Shadow Drive (*Installing the Shadow Drive Valve, page 5*).
If the cable is not long enough, extend the appropriate wires with 0.08 mm² (28 AWG) wire.

Installing the Shadow Drive Valve

Connecting the Shadow Drive Valve to the Hydraulic System

Before you can install the Shadow Drive valve, you must select a location at which to connect the Shadow Drive to the hydraulic steering of your boat (*Shadow Drive™ Mounting Considerations, page 2*).

For further assistance, consult the hydraulic-layout diagrams included with your pump.

Use hydraulic connectors (not included) to install the Shadow Drive valve in the appropriate hydraulic line.

Connecting the Shadow Drive Valve to the CCU

- 1 Route the bare-wire end of the CCU cable to the Shadow Drive valve.
If the cable is not long enough, extend the appropriate wires with 28 AWG (0.08 mm²) wire.

- 2 Connect the cables, based on this table.

Shadow Drive Valve Wire Color	CCU Cable Wire Color
Red (+)	Brown (+)
Black (-)	Black (-)

- 3 Solder and cover all bare-wire connections.

Installing the Alarm

Before you can mount the alarm, you must select a mounting location (*Alarm Mounting and Connection Considerations, page 2*).

- 1 Route the alarm cable to the bare-wire end of the CCU cable.
If the cable is not long enough, extend the appropriate wires with 28 AWG (0.08 mm²) wire.
- 2 Connect the cables, based on this table.

Alarm Wire Color	CCU Cable Wire Color
White (+)	Orange (+)
Black (-)	Blue (-)

- 3 Solder and cover all bare-wire connections.

- 4 Secure the alarm with cable ties or other mounting hardware (not included).

NMEA 2000 and the Autopilot Components

A dedicated helm control is not included in all autopilot packages. If you install the autopilot without a dedicated helm control, the autopilot CCU must be connected to the same NMEA 2000 network as a compatible Garmin chartplotter to configure and control the autopilot system.

NOTICE

If you are connecting this device to an existing NMEA 2000 network, the NMEA 2000 network should already be connected to power. Do not connect the NMEA 2000 power cable to an existing NMEA 2000 network, because only one power source should be connected to a NMEA 2000 network.

If you are connecting this device to an existing NMEA 2000 network or engine network by another manufacturer, you should install a NMEA 2000 Power Isolator (010-11580-00) between the existing network and the Garmin devices.

You can connect the CCU and the optional helm control through an existing NMEA 2000 network. If you do not have an existing NMEA 2000 network on your boat, all the parts needed to build one are supplied in the autopilot package (*Building a Basic NMEA 2000 Network for the Autopilot System, page 5*).

To use the advanced features of the autopilot, optional NMEA 2000 devices, such as a GPS device, can be connected to the NMEA 2000 network.

If you are unfamiliar with NMEA 2000, you should read the “NMEA 2000 Network Fundamentals” chapter of the *Technical Reference for NMEA 2000 Products*. To download this document, select Manuals on the product page for your device at www.garmin.com.

Building a Basic NMEA 2000 Network for the Autopilot System

NOTICE

If you are installing a NMEA 2000 power cable, you must connect it to the boat ignition switch or through another in-line switch. NMEA 2000 devices will drain your battery if the NMEA 2000 power cable is connected to the battery directly.

A dedicated helm control is not included in all autopilot packages. If you install the autopilot without a dedicated helm control, the autopilot CCU must be connected to the same NMEA 2000 network as a compatible Garmin chartplotter to configure and control the autopilot system.

- 1 Connect the three T-connectors ① together side-by-side.

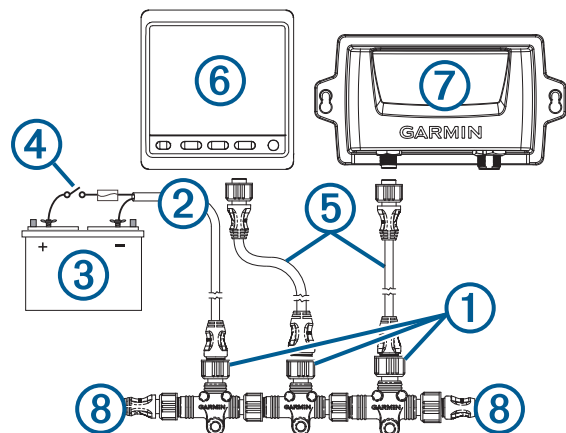

- 2 Connect the included NMEA 2000 power cable ② to a 9 to 12 Vdc power source ③ through a switch ④.
You should connect the power cable to the ignition switch of the boat if possible, or route it through an inline switch (not included).

NOTE: The braided drain wire (bare) on the NMEA 2000 power cable must be connected to the same ground as the black wire on the NMEA 2000 power cable.

- 3 Connect the NMEA 2000 power cable to one of the T-connectors.
- 4 Connect one of the included NMEA 2000 drop cables ⑤ to one of the T-connectors and to the helm control (optional) or to a compatible Garmin chartplotter ⑥.
- 5 Connect the other included NMEA 2000 drop cable to the other T-connector and to the CCU ⑦.
- 6 Connect the male and female terminators ⑧ to each end of the combined T-connectors.

Connecting the Autopilot Components to an Existing NMEA 2000 Network

A dedicated helm control is not included in all autopilot packages. If you install the autopilot without a dedicated helm control, the autopilot CCU must be connected to the same NMEA 2000 network as a compatible Garmin chartplotter to configure and control the autopilot system.

- 1 Determine where to connect the CCU ① and the helm control (optional) ② to your existing NMEA 2000 backbone ③.

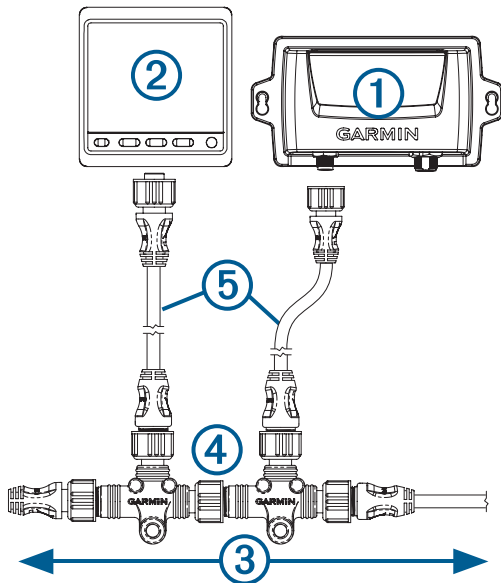

- 2 In the location where you plan to connect the CCU, disconnect one side of a NMEA 2000 T-connector ④ from the network.
- 3 If necessary, connect a NMEA 2000 backbone extension cable (not included) to the side of the disconnected T-connector to extend the NMEA 2000 network backbone.
- 4 Add an included T-connector for the CCU to the NMEA 2000 backbone by connecting it to the side of the disconnected T-connector or backbone extension cable.
- 5 Route the included drop cable ⑤ to the CCU and to the bottom of the T-connector added in step 4.
If the included drop cable is not long enough, you can use a drop cable up to 6 m (20 ft.) long (not included).
- 6 Connect the drop cable to the CCU and the T-connector.
- 7 If needed, repeat steps 2 through 6 for the helm control (optional) or a compatible Garmin chartplotter.

Connecting Optional NMEA 2000 Devices to the Autopilot System

You can use advanced features of the autopilot system by connecting optional NMEA 2000 compatible devices, such as a GPS device, to the NMEA 2000 network.

NOTE: You can connect optional devices that are not NMEA 2000 compatible to the helm control through NMEA 0183 (*NMEA 0183 Connection Considerations, page 7*).

- 1 Add an additional T-connector (not included) to the NMEA 2000 network.
- 2 Connect the optional NMEA 2000 device to the T-connector by following the instructions provided with the device.

Bleeding the Hydraulics

NOTICE

This is a general procedure for bleeding a hydraulic steering system. Refer to the instructions provided by the manufacturer of the steering system for more-specific information about bleeding the system.

Before you bleed the hydraulic system, you should verify that all hose connections are complete and fully tightened.

- 1 Select an option:
 - If the helm reservoir contains insufficient fluid, fill it as needed.
 - If the helm reservoir contains excess fluid, remove the excess to avoid fluid overflow during the bleeding process.
- 2 Insert a bypass hose between the cylinder bleed ports.

TIP: If you use a clear plastic hose for this bypass, you can observe air bubbles during the bleeding processes.
- 3 Manually steer the helm fully to port.
- 4 Open both bypass valves at the cylinder fittings.
- 5 Manually turn the helm slowly to port over three minutes.

TIP: You can stop turning when you no longer see air moving through the bypass hose.
- 6 Turn on the autopilot system and disable the Shadow Drive. You can refer to the autopilot system documentation for more information on disabling the Shadow Drive.
- 7 Hold ← (port) on the helm control for at least 10 seconds.

TIP: You can stop holding ← when you no longer see air moving through the bypass hose.
- 8 Close both bypass valves at the cylinder fittings.
- 9 If necessary, add fluid to the helm reservoir.
- 10 Repeat steps 3 through 9 for the starboard side.
- 11 Hold ← (port) on the helm control until steering stops and **Hydraulic Pump Stall** is shown on the helm control.
- 12 Hold → (starboard) on the helm control until steering stops and **Hydraulic Pump Stall** is shown on the helm control.
- 13 Select an option:
 - If **Hydraulic Pump Stall** is not shown within 2 to 3 seconds after the cylinder stops, repeat steps 1-13 to bleed the system again.
 - If **Hydraulic Pump Stall** is shown within 2 to 3 seconds after the cylinder stops, the system bleed completed successfully.

After hydraulic bleeding is complete, you can re-enable the Shadow Drive.

Corrosion Blocker

NOTICE

To ensure the long life of all parts, apply corrosion blocker to the pump at least twice yearly.

A marine-rated corrosion blocker should be applied to the pump after all hydraulic and electrical connections are made and the hydraulic system has been bled.

Configuration

The autopilot must be configured and tuned to your boat dynamics. You can use the Dockside Wizard and the Sea Trial

Wizard on the helm control or a compatible Garmin chartplotter to configure the autopilot.

See the included configuration guide for more information on configuring the autopilot.

Appendix

NMEA 0183 Connection Diagrams

The helm control is not included in all autopilot packages. A helm control must be installed in your autopilot system to connect NMEA 0183 devices according to these diagrams. If you install the autopilot without a helm control, all NMEA devices you plan to use with the autopilot system must be connected to a compatible Garmin chartplotter on the same NMEA 2000 network as the CCU. See the installation instructions provided with your chartplotter for NMEA 0183 connection information.

These wiring diagrams are examples of different situations you may encounter when connecting your NMEA 0183 device to the helm control.

NMEA 0183 Connection Considerations

- There is one internal NMEA 0183 input port (RX port) and one internal NMEA 0183 output port (TX port) on the included NMEA 0183 data cable. You can connect one NMEA 0183 device to the internal RX port to input data to this Garmin device, and you can connect up to three NMEA 0183 devices in parallel to the internal TX port to receive data output by this Garmin device.
- See the installation instructions for the NMEA 0183 device to identify the transmit (TX) and receive (RX) wires.
- The device provides one TX port and one RX port. Each internal port has 2 wires, labeled A and B according to the NMEA 0183 convention. The corresponding A and B wires of each internal port should be connected to the A (+) and B (-) wires of the NMEA 0183 device.
- You must use 28 AWG, shielded, twisted-pair wiring for extended runs of wire. Solder all connections and seal them with heat-shrink tubing.
- Do not connect the NMEA 0183 data wires from this device to power ground.
- The power cable from this device and the NMEA 0183 devices must be connected to a common power ground.
- For two-way communication with a NMEA 0183 device, the internal ports on the NMEA 0183 data cable are not linked. For example, if the input of the NMEA 0183 device is connected to TXA on the data cable, you can connect the output port of your NMEA 0183 device to the input port on the wiring harness.
- See [Specifications, page 8](#) for a list of the approved NMEA 0183 sentences that are output by and input to this device.
- The internal NMEA 0183 ports and communication protocols are configured on the connected Garmin device. See the NMEA 0183 section of the chartplotter owner's manual for more information.

Two-Way NMEA 0183 Communication

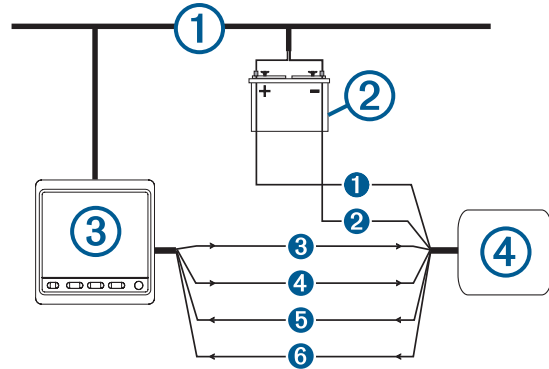

①	NMEA 2000 network (provides power to the helm control)
②	12 Vdc power source
③	Helm control
④	NMEA 0183 compatible device

Wire	Helm Control Wire Color — Function	NMEA 0183 Compatible Device Wire Function
①	N/A	Power
②	N/A	NMEA 0183 ground
③	Blue — Tx/A (+)	Rx/A (+)
④	White — Tx/B (-)	Rx/B (-)
⑤	Brown — Rx/A (+)	Tx/A (+)
⑥	Green — Rx/B (-)	Tx/B (-)

NOTE: When connecting a NMEA 0183 device with two transmitting and two receiving lines, you do not need to connect the NMEA 2000 bus and the NMEA 0183 device to a common ground.

Only One Receiving Wire

If your NMEA 0183 compatible device has only one receiving wire (Rx), you must connect it to the blue wire (Tx/A) from the helm control, and leave the white wire (Tx/B) from the helm control unconnected.

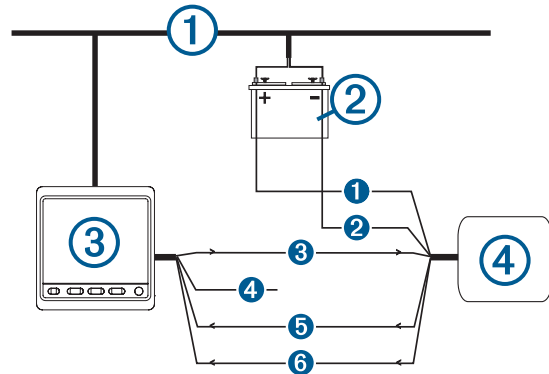

①	NMEA 2000 network (provides power to the helm control)
②	12 Vdc power source
③	Helm control
④	NMEA 0183 compatible device

Wire	Helm Control Wire Color — Function	NMEA 0183 Compatible Device Wire Function
①	N/A	Power
②	N/A	NMEA 0183 ground
③	Blue — Tx/A (+)	Rx
④	White — unconnected	N/A

Wire	Helm Control Wire Color — Function	NMEA 0183 Compatible Device Wire Function
5	Brown — Rx/A (+)	Tx/A (+)
6	Green — Rx/B (-)	Tx/B (-)

NOTE: When connecting a NMEA 0183 device with only one receiving (Rx) line, you must connect the NMEA 2000 bus and the NMEA 0183 device to a common ground.

Only One Transmitting Wire

If your NMEA 0183 compatible device has only one transmitting wire (Tx), it must be connected to the brown wire (Rx/A) from the helm control, and the green wire (Rx/B) from the helm control must be connected to NMEA 0183 ground.

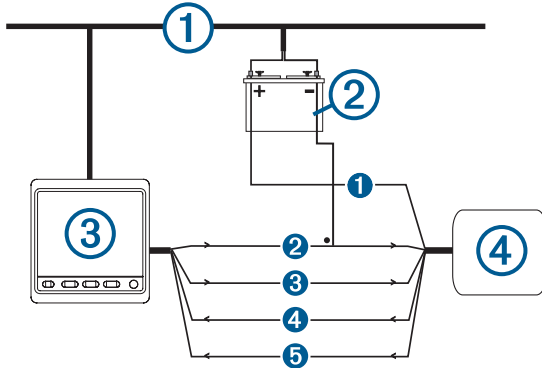

1	NMEA 2000 network (provides power to the helm control)
2	12 Vdc power source
3	Helm control
4	NMEA 0183-compatible device

Wire	Helm Control Wire Color — Function	NMEA 0183 Compatible Device Wire Function
1	N/A	Power
2	Green — Rx/B (-) (connect to NMEA 0183 ground)	NMEA 0183 ground
3	Blue — Tx/A (+)	Rx/A (+)
4	White — Tx/B (-)	Rx/B (-)
5	Brown — Rx/A (+)	Tx/A (+)

NOTE: When connecting a NMEA 0183 device with only one transmitting (Tx) line, you must connect the NMEA 2000 bus and the NMEA 0183 device to a common ground.

Specifications

CCU

Specification	Measurement
Dimensions (L × W × H)	170 × 90 × 50 mm (6.7 × 3.5 × 2 in.)
Weight	200 g (7 oz.)
Temperature range	From -15° to 70°C (from 5° to 158°F)
Material	Fully gasketed, high-impact plastic
Water resistance	IEC 60529 IPX7*
CCU cable length	5 m (16 ft.)
NMEA 2000 input voltage	From 9 to 16 Vdc
NMEA 2000 LEN	4 (200 mA)

*The device withstands incidental exposure to water of up to 1 m for up to 30 min. For more information, go to www.garmin.com/waterrating.

ECU

Specification	Measurement
Dimensions (W × H × D)	168 × 117 × 51 mm (6.6 × 4.6 × 2 in.)
Weight	680 g (24 oz.)

Specification	Measurement
Temperature range	From -15° to 60°C (from 5° to 140°F)
Material	Fully gasketed, high-impact aluminum alloy
Water resistance	IEC 60529 IPX7*
Power cable length	2.7 m (9 ft.)
Input voltage	From 11.5 to 30 Vdc
Fuse	40 A, blade-type
Main power usage	1 A (not including the pump)

*The device withstands incidental exposure to water of up to 1 m for up to 30 min. For more information, go to www.garmin.com/waterrating.

Alarm

Specification	Measurement
Dimensions (L×diameter)	²⁹ / ₃₂ × 1 in. (23 × 25 mm)
Weight	2.4 oz. (68 g)
Temperature range	From 5°F to 140°F (from -15°C to 60°C)
Cable length	10 ft. (3.0 m)

NMEA 2000 PGN Information

CCU

Type	PGN	Description
Transmit and receive	059392	ISO acknowledgment
	059904	ISO request
	060928	ISO address claim
	126208	NMEA: Command/Request/Acknowledge group function
	126464	Transmit/Receive PGN list group function
	126996	Product information
	127257	Transmit/Receive attitude data
Transmit only	127251	Transmit/Receive rate of turn
	127250	Vessel heading
Receive only	127258	Magnetic variation
	127488	Engine parameters: Rapid update
	128259	Water speed
	129025	Position: Rapid update
	129026	COG & SOG: Rapid update
	129283	Cross track error
	129284	Navigation data
	130306	Wind data

Helm Control

Type	PGN	Description
Transmit and receive	059392	ISO acknowledgment
	059904	ISO request
	060928	ISO address claim
	126208	NMEA: Command/Request/Acknowledge group function
	126464	Transmit/Receive PGN list group function
	126996	Product information
	128259	Water speed
Transmit only	129025	Position: Rapid update
	129026	COG & SOG: Rapid update
	129283	Cross track error
	129284	Navigation data
	129540	GNSS satellites in view
	130306	Wind data
Receive only	127245	Rudder data

Type	PGN	Description
	127250	Vessel heading
	127488	Engine parameters: Rapid update
	128259	Water speed
	129025	Position: Rapid update
	129029	GNSS position data
	129283	Cross-track error
	129284	Navigation data
	129285	Navigation: Route/Waypoint information
	130306	Wind data
	130576	Small craft status

NMEA 0183 Information

When connected to optional NMEA 0183 compatible devices, the autopilot uses the following NMEA 0183 sentences.

Type	Sentence
Transmit	hdm
Receive	wpl
	gga
	grme
	gsa
	gsv
	rmc
	bod
	bwc
	dtm
	gll
	rmb
	vhw
	mww
	xte

Error and Warning Messages

Error Message	Cause	Autopilot Action
ECU Voltage is Low	The pump supply voltage has fallen below 10 Vdc for longer than 6 seconds.	<ul style="list-style-type: none"> Alarm sounds for 5 seconds Continues in normal operation
Autopilot is not receiving navigation data. Autopilot placed in Heading Hold.	The autopilot is no longer receiving valid navigation data while performing a Route To maneuver. This message also appears if navigation is stopped on a chartplotter before the autopilot is disengaged.	<ul style="list-style-type: none"> Alarm sounds for 5 seconds Autopilot transitions to heading hold
Connection with Autopilot Lost	The helm control has lost connection with the CCU.	N/A
Lost Wind Data (sailboat only)	The autopilot is no longer receiving valid wind data.	<ul style="list-style-type: none"> Alarm sounds for 5 seconds Autopilot transitions to heading hold
Low GHC™ Supply Voltage	The supply voltage level has fallen below the value specified in the low voltage alarm menu.	N/A
Error: ECU High Voltage	The pump supply voltage has risen above 33.5 Vdc.	<ul style="list-style-type: none"> Alarm sounds for 5 seconds The ECU shuts down

Error Message	Cause	Autopilot Action
Error: ECU Voltage has Dropped Rapidly	The ECU voltage has dropped quickly below 7.0 Vdc.	<ul style="list-style-type: none"> Alarm sounds for 5 seconds The error is cleared when the ECU voltage rises above 7.3 Vdc.
Error: ECU High Temperature	The ECU temperature has risen above 100°C (212°F).	<ul style="list-style-type: none"> Alarm sounds for 5 seconds The ECU shuts down
Error: Lost Communication Between ECU and CCU (when the autopilot is engaged)	Communication between the CCU and the ECU has timed out.	<ul style="list-style-type: none"> The helm control beeps, and autopilot transitions to standby.

Registering Your Device

Help us better support you by completing our online registration today. Keep the original sales receipt, or a photocopy, in a safe place.

- 1 Go to my.garmin.com/registration.
- 2 Sign in to your Garmin account.

Contacting Garmin Support

- Go to support.garmin.com for help and information, such as product manuals, frequently asked questions, videos, and customer support.
- In the USA, call 913-397-8200 or 1-800-800-1020.
- In the UK, call 0808 238 0000.
- In Europe, call +44 (0) 870 850 1241.

© 2017 Garmin Ltd. or its subsidiaries

Garmin® and the Garmin logo are trademarks of Garmin Ltd. or its subsidiaries, registered in the USA and other countries. Reactor™ and Shadow Drive™ are trademarks of Garmin Ltd. or its subsidiaries. These trademarks may not be used without the express permission of Garmin.

NMEA®, NMEA 2000®, and the NMEA 2000 logo are trademarks of the National Marine Electronics Association.



EAC CE